

WALK-THROUGH SURVEY REPORT:
CONTROL TECHNOLOGY FOR CHEMICAL BATCH UNIT OPERATIONS

AT

BASF Wyandotte
Geismar, Louisiana

-

REPORT WRITTEN BY:

Charleston C. K. Wang

REPORT DATE:

December 1983

REPORT NO.:

101-21

NATIONAL INSTITUTE FOR OCCUPATIONAL SAFETY AND HEALTH
Division of Physical Sciences and Engineering
Engineering Control Technology Branch
4676 Columbia Parkway
Cincinnati, Ohio 45226

PLANT SURVEYED: BASF Wyandotte
Geismar, Louisiana

SIC CODE: Group 2869

SURVEY DATE: November 22, 1983

SURVEY CONDUCTED BY: Charleston C. K. Wang
Harold D. Van Wagenen

EMPLOYER REPRESENTATIVES CONTACTED: Thomas J. McBryan, Senior Industrial Hygienist

Acetylenic Plant
Rudolf R. Schnur, Plant Manager
Daniel R. Miller, Superintendent
George Roley, Technical Manager

Ethylene Oxide-Glycol Plant
Thomas G. Fancett, Plant Manager
Jerald Handy, Maintenance Engineer

EMPLOYEE REPRESENTATIVES CONTACTED: None, plant is represented by OCAW

I. INTRODUCTION

The National Institute for Occupational Safety and Health (NIOSH) is the primary Federal agency engaged in occupational safety and health research. Located in the Department of Health and Human Services (formerly DHEW), it was established by the Occupational Safety and Health Act of 1970. This legislation mandated NIOSH to conduct a number of research and education programs separate from the standard setting and enforcement functions carried out by the Occupational Safety and Health Administration (OSHA) in the Department of Labor. An important area of NIOSH research deals with methods for controlling occupational exposure to potential chemical and physical hazards. The Engineering Control Technology Branch (ECTB) of the Division of Physical Sciences and Engineering has been given the lead within NIOSH to study the engineering aspects of health hazard prevention and control.

Since 1976, ECTB has conducted a number of assessments of health hazard control technology on the basis of industry, common industrial process, or specific control techniques. Examples of these completed studies include the foundry industry; various chemical manufacturing or processing operations; spray painting; and the recirculation of exhaust air. The objective of each of these studies has been to document and evaluate effective control techniques for potential health hazards in the industry or process of interest, and to create a more general awareness of the need for or availability of an effective system of hazard control measures.

These studies involve a number of steps or phases. Initially, a series of walk-through surveys is conducted to select plants or processes with effective and potentially transferable control concepts or techniques. Next, in-depth surveys are conducted to determine both the control parameters and the effectiveness of these controls. The reports from these in-depth surveys are then used as a basis for preparing technical reports and journal articles on effective hazard control measures. Ultimately, the information from these research activities builds the data base of publicly available information on hazard control techniques for use by health professionals who are responsible for preventing occupational illness and injury.

This report covers the preliminary site visit (November 22, 1983) to the BASF Wyandotte Corporation chemical manufacturing site at Geismar, Louisiana. Two specific controls were reviewed: 1) the tetrahydrofuran liquid sampling system at the Acetylenics Plant, and 2) the ethylene oxide pumping system at the Ethylene Oxide-Glycol Plant. This visit focused on the control technology employed to minimize occupational safety and health risks there.

II. PLANT AND PROCESS DESCRIPTION

The BASF Wyandotte chemical manufacturing site is located along Highway 30 and is reached by traveling about 3-1/2 miles from the Gonzales exit off I-10. It is between Baton Rouge and New Orleans. A series of natural gas/petroleum-based chemicals including tetrahydrofuran and ethylene oxide are manufactured at this site.

NIOSH personnel surveyed parts of the Acetylenic Plant and the Ethylene Oxide-Glycol Plant.

A. Acetylenic Plant

The Acetylenic Plant contains the tetrahydrofuran (THF) unit. The current price for THF is 96¢/pound. The following reaction path is used for producing tetrahydrofuran:

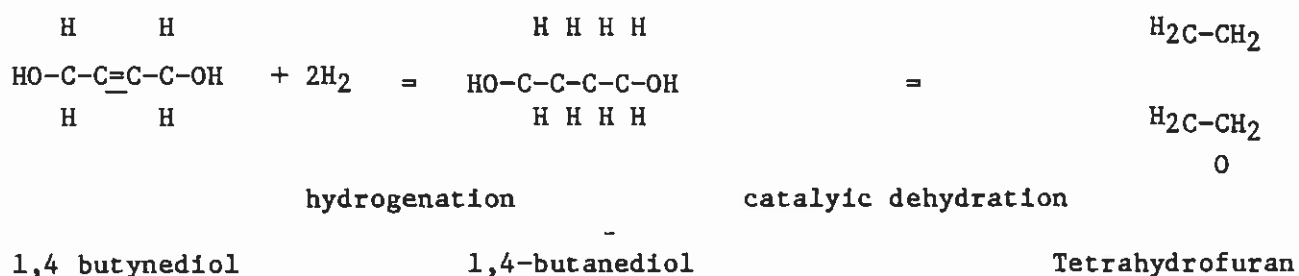

The THF manufacturing operation employs 1 operator/8-hour shift on a 24-hour/day schedule. The plant has operated 1/2-million manhours without a safety accident.

Tetrahydrofuran Hazard Description

Tetrahydrofuran, a colorless liquid with an ether-like odor, is an anesthetic agent and a mild upper respiratory tract irritant. No chronic systemic effects have been reported in humans, although nausea, dizziness, and headaches occur with overexposure and are reversible in fresh air. Prolonged or repeated exposure causes drying of the skin. It is also an eye irritant. The current OSHA standard for tetrahydrofuran is 200 ppm (500 mg/m³) averaged over an 8-hour work shift.

Tetrahydrofuran also presents a fire safety problem, as the flash point is -14.5°C (closed cup) and the auto ignition temperature is 321°C. The flammable limits in air are 2 (lower) and 11.8 (upper) percent by volume.

BASF personnel note that THF can be ignited by static electricity sparks.

B. Ethylene Oxide-Glycol Plant

Ethylene oxide is made at the plant by the catalytic oxidation of ethylene:

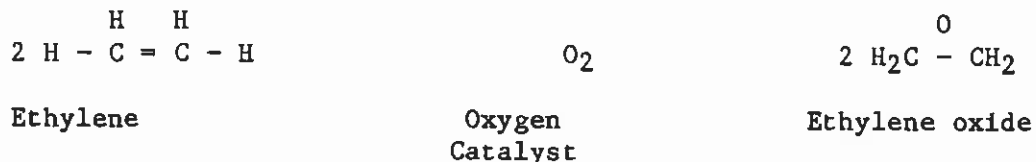

The processing technology used at BASF is licensed from SHELL (1957 catalyst technology). The reactors are cooled with liquid kerosene, which has a boiling range similar to the reaction temperature.

The plant produces 700 tons of ethylene oxide per year.

The plant employs 5 employees per 8-hour shift on a 24-hour basis. Three operators are assigned to leak checking duties and to take instrument readings. Leaks are checked by listening, but ethylene leaks can also be detected by its distinct sweetish odor.

(1) Ethylene Oxide Hazard Description

Ethylene oxide is a colorless gas with a sweetish odor. Ethylene oxide is used as an intermediate in organic synthesis for ethylene glycol, polyglycols, glycol ethers, esters, ethanolamines, acrylonitrile, plastics, and surface-active agents. It is also used as a fumigant for foodstuffs and textiles, an agricultural fungicide, and for sterilization, especially for surgical instruments.

Inhalation of ethylene oxide may cause nausea, vomiting, irritation of the nose, throat, and lungs. Pulmonary edema may occur. Ethylene oxide is also an anesthetic gas which can cause drowsiness and unconsciousness.

Ethylene oxide is a suspected human carcinogen and is a demonstrated carcinogen in female mice.

Local exposure to aqueous solutions of ethylene oxide are irritating to the skin and eyes. Large quantities of ethylene oxide evaporating from the skin may cause frostbite.

The current standard for ethylene oxide is 50 ppm for an 8-hour work shift (90 mg/m³). The ACGIH Threshold Limit Value is 10 ppm for a time-weighted average of 8 hours.

III. PRINCIPLES OF CONTROL

Occupational exposures can be controlled by the application of a number of well-known principles, including engineering measures, work practices, personal protection, and monitoring. These principles may be applied at or near the hazard source, to the general workplace environment, or at the point of occupational exposure to individuals. Controls applied at the source of the hazard, including engineering measures (material substitution, process/equipment modification, isolation or automation, local ventilation) and work practices, are generally the preferred and most effective means of control both in terms of occupational and environmental concerns. Controls which may be applied to hazards that have escaped into the workplace environment include dilution ventilation, dust suppression, and housekeeping. Control measures may also be applied near individual workers, including the use of remote control rooms, isolation booths, supplied-air cabs, work practices, and personal protective equipment.

In general, a system comprised of the above control measures is required to provide worker protection under normal operating conditions as well as under conditions of process upset, failure and/or maintenance. Process and workplace monitoring devices, personal exposure monitoring, and medical monitoring are important mechanisms for providing feedback concerning effectiveness of the controls in use. Ongoing monitoring and maintenance of controls to insure proper use and operating conditions, and the education and commitment of both workers and management to occupational health are also important ingredients of a complete, effective, and durable control system.

These principles of control apply to all situations, but their optimum application varies from case-to-case. The application of these principles are discussed below.

A. Acetylenic Plant - Control Technology for Liquid Sampling

The Control Problem

Liquid sampling units are located at eight process locations within the Acetylenic plant. including the end of the reaction process for finished THF. The most hazardous sample is taken at the flowstream before entering the reboiler. The THF is sampled at various temperatures, including some samples at below ambient temperatures. After the sample is taken, it is carried to the analytical laboratory where it is allowed to reach ambient temperature prior to removal. Sampling frequency is one sample per day at the minimum. Frequency is increased during unsteady state operation, e.g. during startup. Typical sample size is 4 ounces.

The Control Technology

The control technology reviewed consists of a BASF designed, custom built liquid sampling device. Figure A shows a diagram of the device and Figure B is a photograph of the actual device.

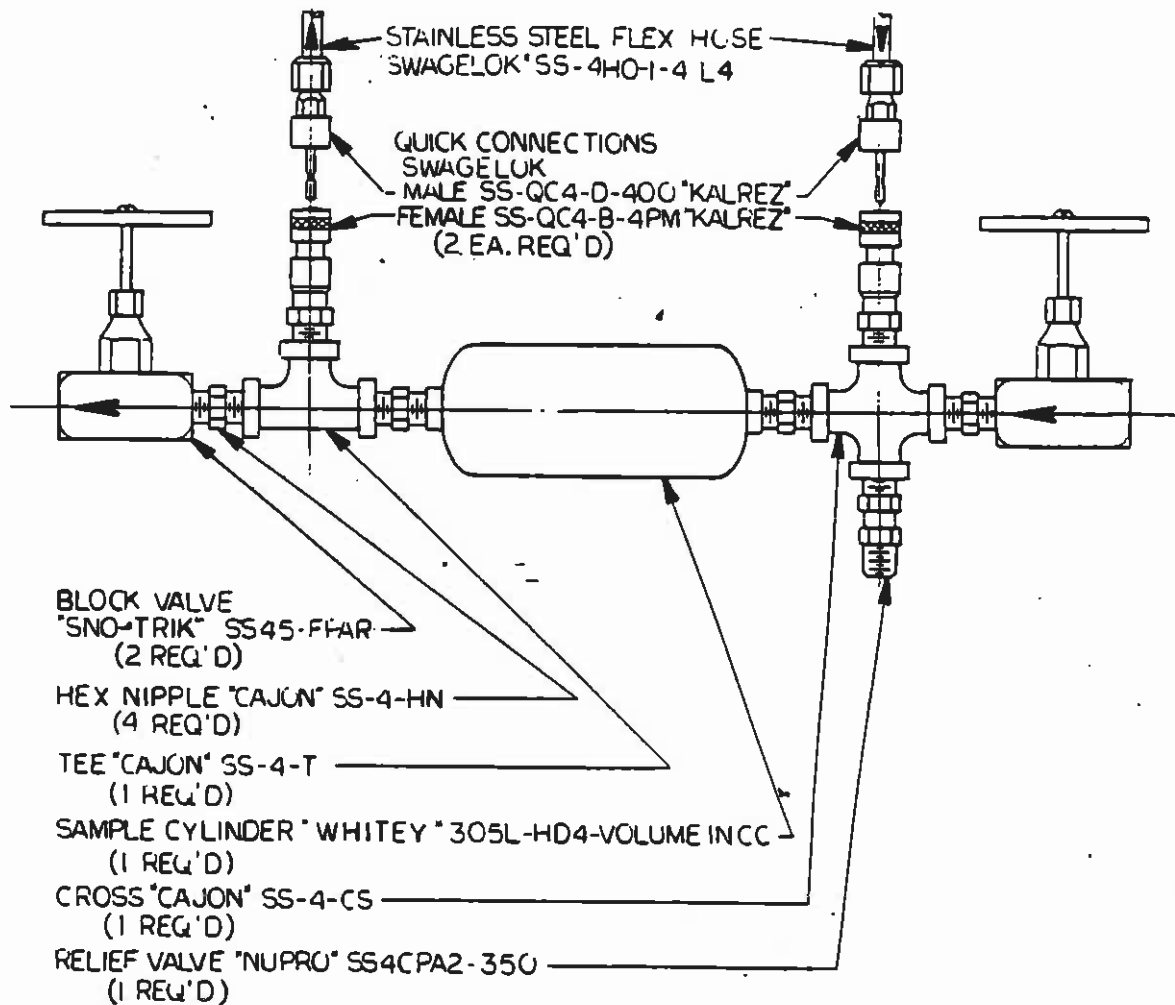

DETAIL "A"
THE SAMPLE CYLINDER

Figure A

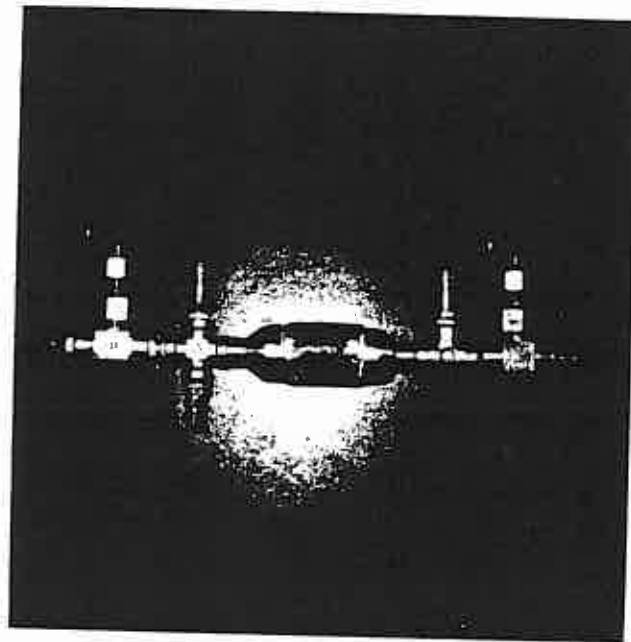

Figure B

As can be seen from the above figures, the device is fabricated from:

- 1) One sample cylinder "Whitey" 305L-HD4-V
- 2) Two block valves "SNO-TRIK" SS45-FPAR
- 3) One T "CAJON" SS-4-T
- 4) One Cross "CAJON" SS-4-CS
- 5) One relief valve "NUPRO" SS4CPA2-350 - A feature worth noting, especially if samples taken at below ambient temperatures will expand appreciably when warmed.
- 6) Four Hex Nipple "CAJON" SS-4-HN
- 7) Two stainless steel flex hoses, "SWAGELOK" SS-4HO-1-4-L4 with "SWAGELOK" male quick connections SS-QC4-D-400 at end. The male connectors are spring loaded for automatic sealing. Washers are made from "KALREZ". The flex hose is rated for 5,000 pounds pressure.
- 8) Two "SWAGELOK" female quick connectors SS-QC4-B-4PM with KALREZ washers.

All connections on the sampling device are screw treaded, with teflon tape used on the threads to give a maximum seal against leaks.

The cost of each sampling device is about \$300 for all materials and one hour of labor for assembly.

Technique for Using the Liquid Sampling Device

To obtain a sample of the process stream, the pin valves are closed and plug connectors removed and the sampling device is attached to the stainless steel flex hose via the "SWAGELOK" quick connectors. Figure C illustrates a typical installation. The pin valves are opened and the sampling stream is allowed to flow for 30 minutes in order that the sample cylinder is thoroughly flushed. The pin valves are closed, and the sampling device is disconnected from the flex hoses. Female plugs are attached to the flex hose to prevent leakage. The device or "bomb" is carried to the laboratory where its contents are analyzed.

Benefits from the Control Technology

- 1) Reduce risk of fire (eliminates static electricity fires).
- 2) Reduce exposure (liquid contact and vapor inhalation) to operators.

Limitations of the Control Technology

- 1) Not suitable for sampling liquids containing suspended material as the solids will plug up the device or cause leaks.

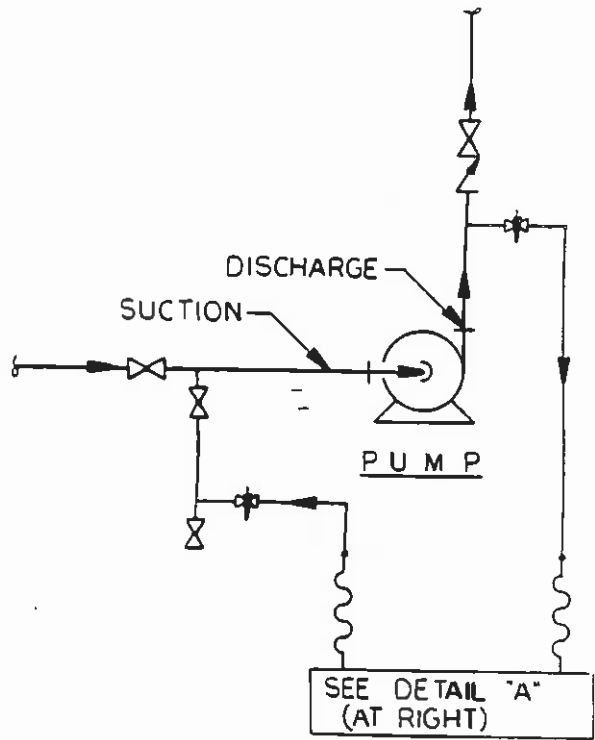

TYPICAL INSTALLATION FOR
THE SAMPLE CYLINDER

Figure C

Note: Use of similar sampling bombs has been observed by NIOSH investigators at a refinery for benzene sampling. One major problem they had was that the bombs were dropped and fittings were damaged. This was overcome by welding a carrying handle on the bomb, which was large enough that it could be slipped over the handlebars of the bicycle the operator used for transportation. Older bombs were retrofitted by fastening the handle using screw-type hose clamps instead of welding.

B. The Ethylene Oxide Plant - Control Technology for Pump Sealing

The Control Problem

Hot ethylene oxide liquid causes rapid chemical attack on the rotating seals used in centrifugal pumps operating at the plant. The problem is most severe at the pump which recirculates ethylene oxide at 140°F from the boiler to the ethylene oxide fractionating column. Double mechanical seals do not assure full control of leaks. In 1981, there were 8 seal failures costing \$2,000 to repair each seal. EPR O-rings were chemically attacked and started leaking in 2 weeks of operation. Even Kalrez^(T) O-rings eventually failed when the pump is used to transport ethylene oxide solutions at 140°F.

The Control Technology

The control technology system used to greatly reduce seal failures is shown in Figure D. A seal flush liquid is used to cool the double mechanical seal. Figure E shows a double mechanical seal. The liquid used in the seal flush is tapped from the pump discharge (at 140°F) and passed through a heat exchanger to cool it to a lower temperature. Experience by the plant indicated that 110°F is the optimal processing temperature. The seal flush liquid is recirculated into the main product stream. The plant reports that the use of this cooled seal flush has reduced pump failures by 50%.

Figure F shows pump with the flush seal liquid piping.

Figure G and H shows the heat exchanger used for cooling the flush seal liquid. Note the temperature difference on the gas gauges of the ethylene oxide going into the heat exchanger (approximately 135°F) and leaving the heat exchanger (approximately 110°F).

The plant reports spending over \$50,000 in the development of the control technology.

Benefits of the Control Technology

The use of the cooling system was effective in reducing the rate of seal failure. The plant reports a reduction of of 50%. As a result, the emission of ethylene oxide into the plant environment is correspondingly reduced. As seals fail less often the need for pump maintenance is also reduced. This results in a reduction in the manually handling of contaminated pump parts by maintenance personnel.

BY _____ DATE _____ SUBJECT GA-7101 SEAL FLUSH
AND BARRIER FLUID
CHK'D BY _____ DATE _____
PROJ. NO. _____

BOOK NO. _____
SHEET NO. _____ OF _____
APPROP. NO. _____

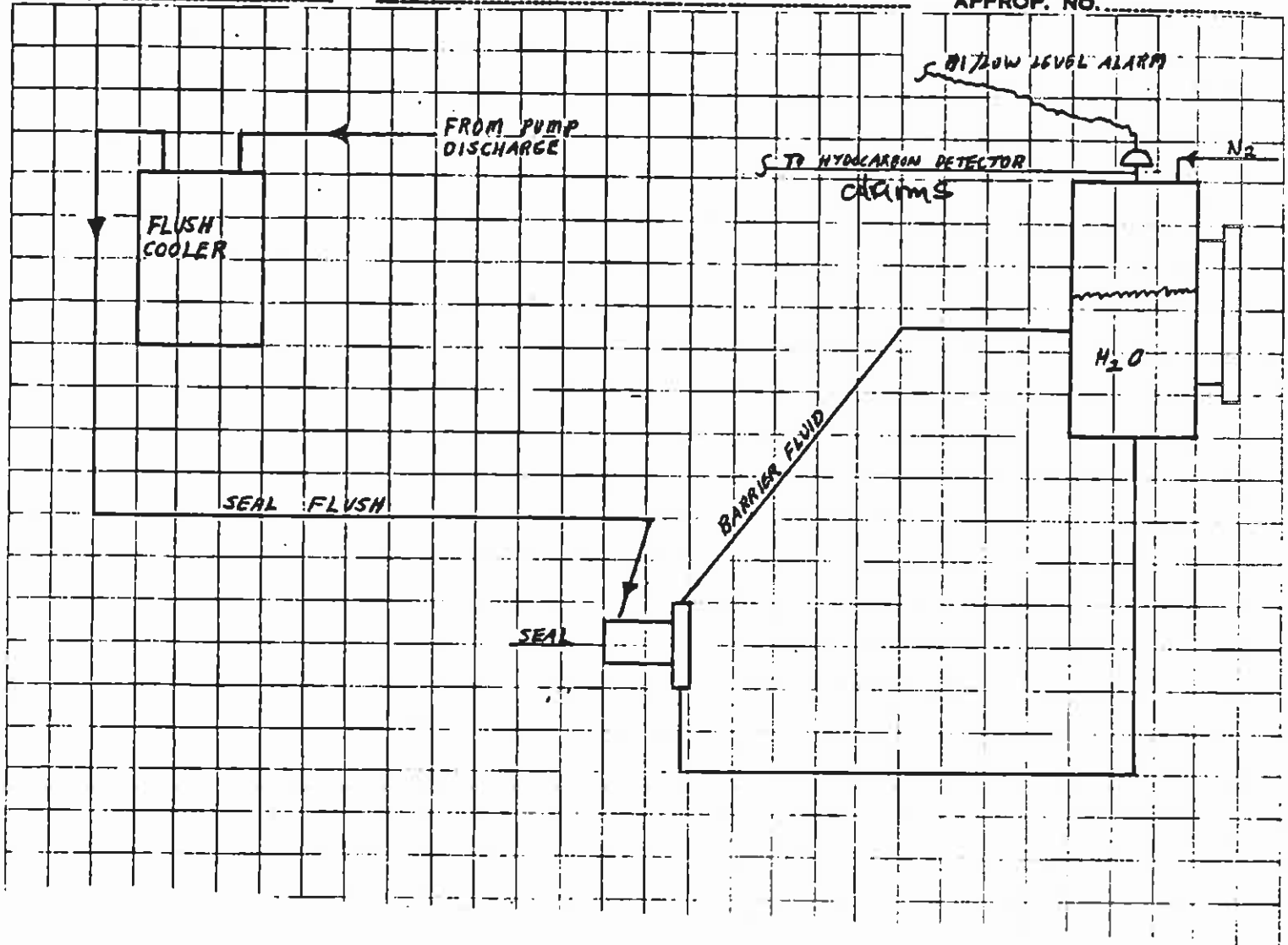

Figure D

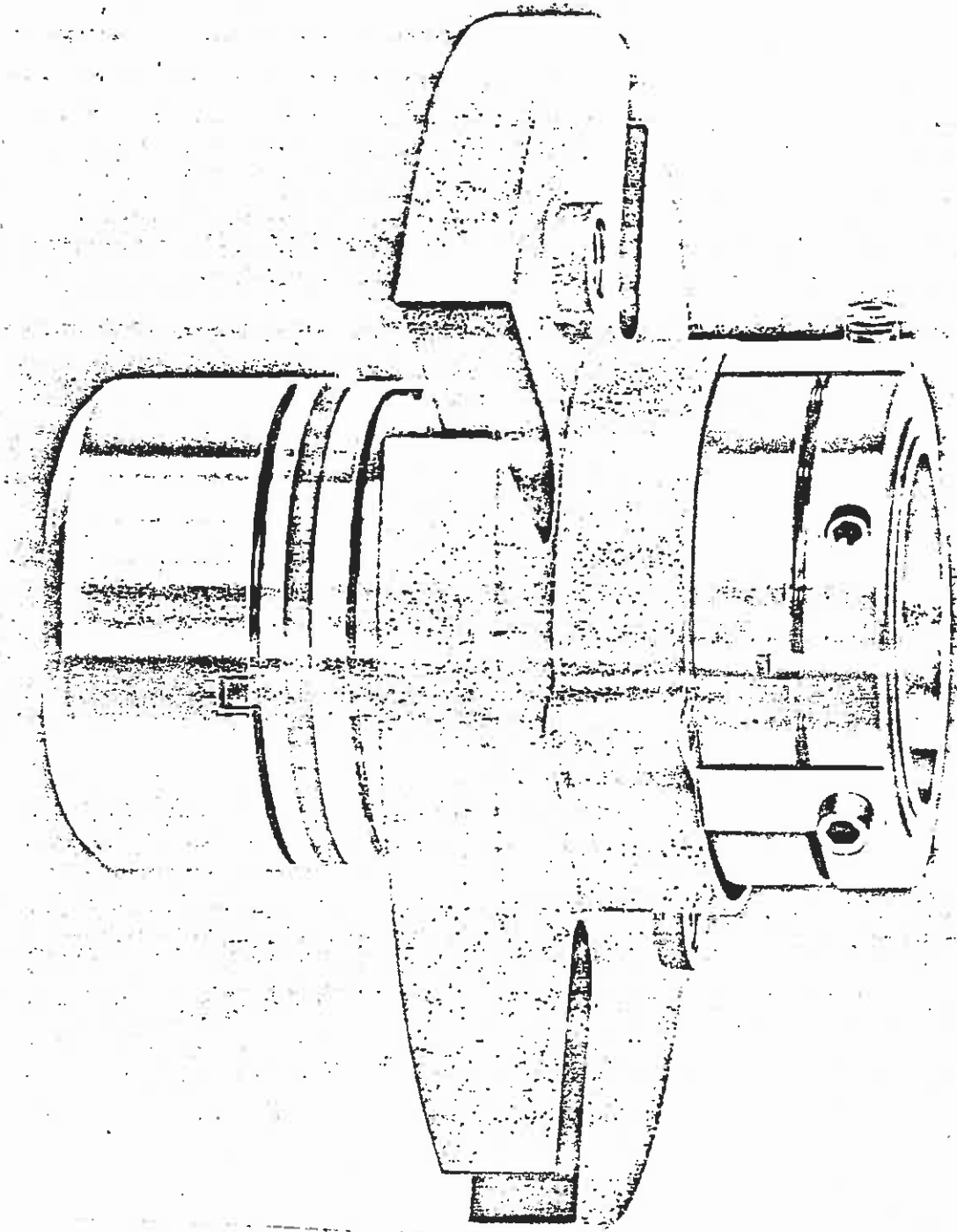

Figure E

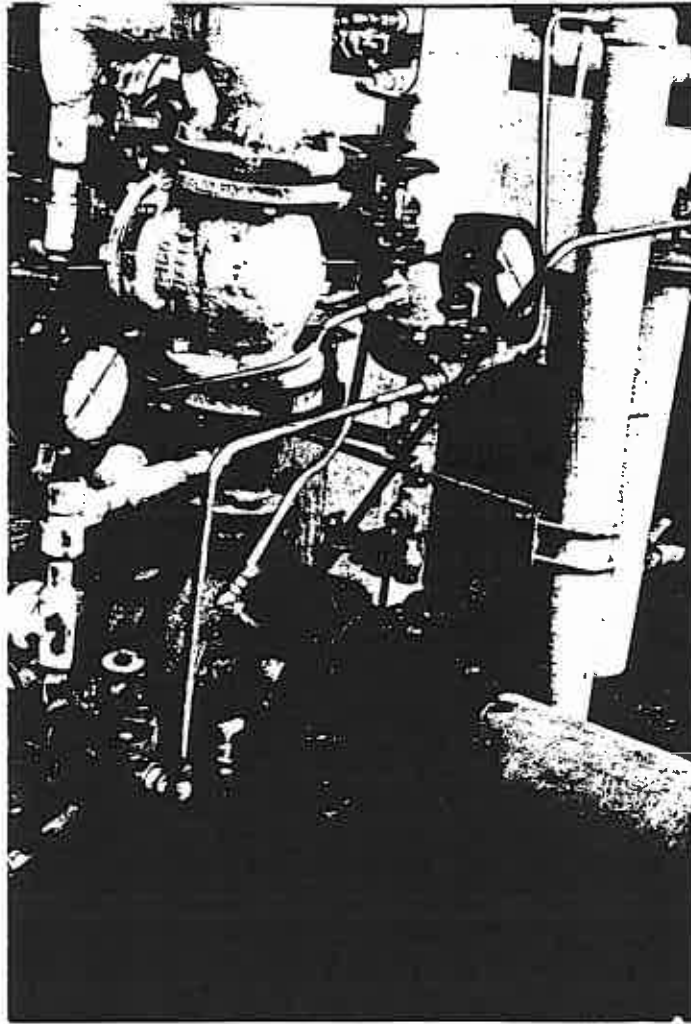

Figure F

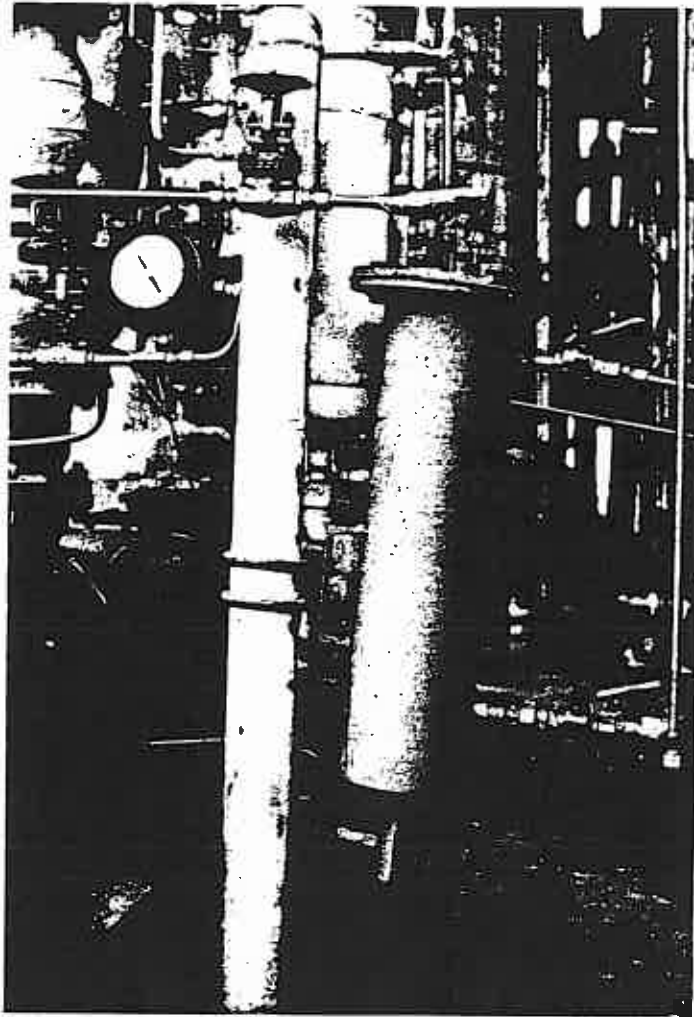

Figure G

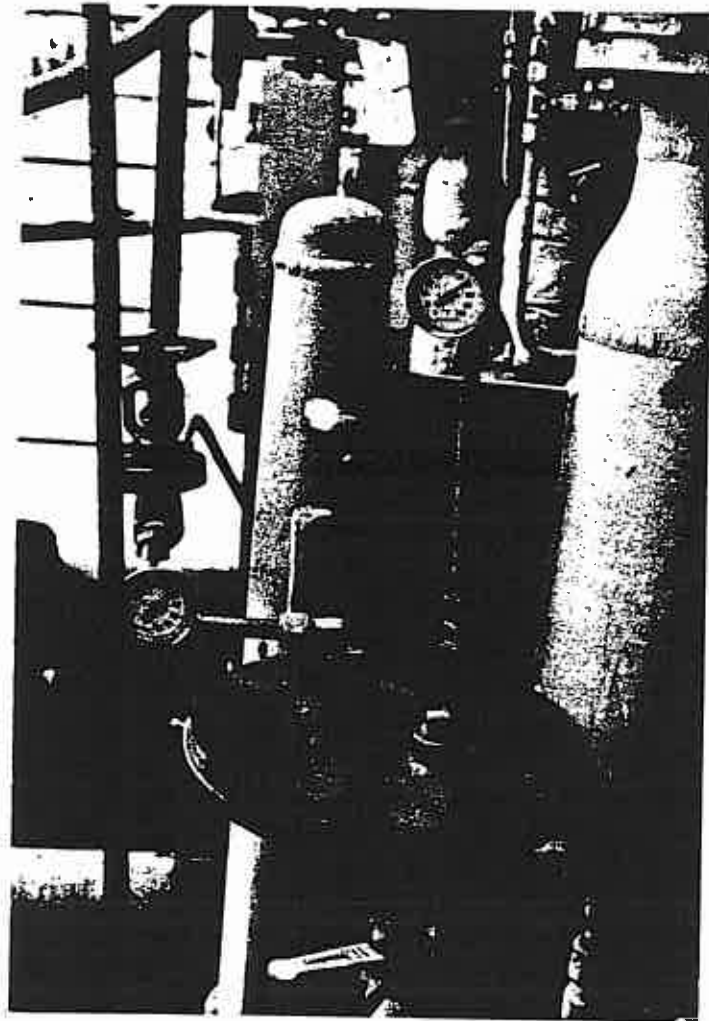

Figure H

Limitations of the Control Technology

Pump failure is not totally eliminated.

IV. CONCLUSION AND RECOMMENDATIONS

The two control technologies reviewed were interesting and can be of general application to other similar processes. An in-depth survey is recommended at the BASF plant with the possibility of including other control technologies practical at the two plants. An in-depth study with such an expanded scope would yield more useful information which could benefit employees' safety and health.