

RI 9697

REPORT OF INVESTIGATIONS/2015

Shotcrete Design and Installation Compliance Testing:

Early Strength, Load Capacity, Toughness,
Adhesion Strength, and Applied Quality



Report of Investigations 9697

Shotcrete Design and Installation Compliance Testing: Early Strength, Load Capacity, Toughness, Adhesion Strength, and Applied Quality

Lewis A. Martin, Curtis C. Clark, Joseph B. Seymour, and Michael A. Stepan

DEPARTMENT OF HEALTH AND HUMAN SERVICES
Centers for Disease Control and Prevention
National Institute for Occupational Safety and Health
Office of Mine Safety and Health Research
Pittsburgh, PA • Spokane, WA

March 2015

This document is in the public domain and may be freely copied or reprinted.

Disclaimer

Mention of any company or product does not constitute endorsement by the National Institute for Occupational Safety and Health (NIOSH). In addition, citations to Web sites external to NIOSH do not constitute NIOSH endorsement of the sponsoring organizations or their programs or products. Furthermore, NIOSH is not responsible for the content of these Web sites. All Web addresses referenced in this document were accessible as of the publication date.

Ordering Information

To receive documents or other information about occupational safety and health topics, contact NIOSH at

Telephone: **1-800-CDC-INFO** (1-800-232-4636)

TTY: 1-888-232-6348

CDC INFO: **www.cdc.gov/info**

or visit the NIOSH Web site at **www.cdc.gov/niosh**.

For a monthly update on news at NIOSH, subscribe to NIOSH *eNews* by visiting **www.cdc.gov/niosh/eNews**.

Suggested Citation

NIOSH [2014]. Shotcrete design and installation compliance testing: early strength, load capacity, toughness, adhesion strength, and applied quality. By Martin LA, Clark CC, Seymour JB, and Stepan MA. Spokane WA: U.S. Department of Health and Human Services, Centers for Disease Control and Prevention, National Institute for Occupational Safety and Health, DHHS (NIOSH) Publication No. 2015-107, RI 9697.

DHHS (NIOSH) Publication No. 2015-107

March 2015

SAFER • HEALTHIER • PEOPLE™

Cover photo by NIOSH.

Contents

Executive Summary	1
Development of Portable Test Machines	1
Shotcrete Characteristics and Application	2
Introduction	3
Research Impetus and Report Contents.....	3
Shotcrete and Weak Rock.....	3
Shotcrete Quality Monitoring for Safety	3
Background.....	4
Ground Control and Rockfalls.....	4
Weak Rock Conditions	5
Weak Rock Mining Method.....	7
Typical Top-Cut Mining Cycle for Weak Rock.....	8
Application and Use of Shotcrete for Surface Control in Weak Rock	11
Shotcrete Parameters	20
Shotcrete Mix Types.....	20
Shotcrete Mix Constituents.....	23
Shotcrete Reinforcement Methods	24
Shotcrete Mix Characteristics	26
Shotcrete Application.....	27
Field Testing Methods for Shotcrete Application	28
Slump Test	29
Compression Test	31
Early Strength, Partial-beam Compression Test.....	31
Overcoring and Direct-Tension Pull Test	43
Round Determinate Panel Flexural Test.....	57
Comparison of Shotcrete Support Systems Based on RDP Tests	84
Quality Control Testing in the Field.....	92
Summary and Conclusions	95
Early Strength, Partial-beam Compression Test.....	95
Overcoring and Direct-tension Pull Test	96
Round Determinate Panel Test	96
Summary of Discussion.....	97
Acknowledgements.....	98
References	99
Appendix.....	105
Equipment Specifications for Portable Shotcrete Test Machines	105
Conversion of Pressure Gauge Bond Strength Test Values to Direct Tensile Force	108

Figures

Figure 1. Distribution of lost-time injuries in underground metal mines by accident class, 2006–2010 (operator and contractor cases).....	5
Figure 2. Poor-quality, raveling rock in an underground gold mine in Nevada.....	6
Figure 3. Poor-quality, highly deformable rock in an underground gold mine in Nevada.....	6
Figure 4. Final in-cycle application of wet mix shotcrete.....	7
Figure 5. Drilling the first blast round.....	8
Figure 6. Blasting the first round.....	8
Figure 7. Applying first layer of shotcrete.....	8
Figure 8. Removing blasted rock or muck with loader.....	9
Figure 9. Installing short bolts and welded wire mesh.....	9
Figure 10. Drilling a second blast round.....	9
Figure 11. Blasting the second round.....	10
Figure 12. Installing a second layer of shotcrete.....	10
Figure 13. Removing blasted rock or muck with loader.....	10
Figure 14. Installing long primary bolts.....	11
Figure 15. Installing short bolts and welded wire mesh.....	11
Figure 16. Application of a thin initial layer or flash coat of shotcrete.....	12
Figure 17. Installation of welded wire mesh, plates, and short bolts.....	12
Figure 18. Application of a second layer of shotcrete.....	13
Figure 19. Completed ground control system with plated, long primary bolts through the matrix and shorter bolts to the springline.....	14
Figure 20. Multi-element ground support system for weak rock.....	15
Figure 21. Plan view of primary bolt pattern, looking up at the back from below.....	16
Figure 22. Flexural failure of shotcrete resulting from insufficient adhesion strength.....	17
Figure 23. Two basic types of shotcrete failure modes: A – fallout of only shotcrete and B – fallout of shotcrete and rock.....	17
Figure 24. Schematic of shotcrete loading and failure modes.....	18
Figure 25. Supermesh provides support between the primary bolts.....	19
Figure 26. Shotcrete failure modes that can be prevented by the addition of welded wire mesh.....	19
Figure 27. Simplified schematic of a typical dry mix shotcrete system.....	21
Figure 28. Operation of a dry mix shotcrete machine equipped with a rotary barrel.....	21
Figure 29. Simplified schematic of a typical wet mix shotcrete system.....	22
Figure 30. Operation of a wet mix shotcrete machine.....	22
Figure 31. Consistency of wet mix shotcrete being loaded into the hopper of a shotcrete machine.....	30

Figure 32. Filling a slump cone with wet mix shotcrete prior to conducting a slump test in an underground mine.....	30
Figure 33. Slump test with wet mix shotcrete showing a 292-mm (11.5-in) slump; typical slump is 100 to 200 mm (4 to 8 in).	31
Figure 34. Portable shotcrete test machine designed by NIOSH researchers.	32
Figure 35. Operation of portable shotcrete test machine.	33
Figure 36. Diagram of the compressive forces applied to a partial-beam shotcrete sample during an early strength test.....	33
Figure 37. Partial-beam shotcrete mold (left) and shotcrete test sample (right).	34
Figure 38. Containment fixtures and molds for making partial-beam shotcrete samples	35
Figure 39. Loading of a partial-beam shotcrete sample during an early strength test.	35
Figure 40. Shotcrete sample showing vertical shear failure.....	36
Figure 41. Shotcrete sample showing single side failure, loaded from top and bottom of specimen.	36
Figure 42. Shotcrete sample showing dual side failure, loaded from top and bottom of specimen.	37
Figure 43. Shotcrete sample showing exposed failure plane.....	37
Figure 44. Shotcrete failure modes	37
Figure 45. Early-age compressive strength versus curing time for sprayed and cast samples of K1 shotcrete for 1 to 6 hours of curing time.....	38
Figure 46. Early-age compressive strength versus curing time for sprayed partial-beam samples of 5 shotcrete mixes for 1 to 6 hours of curing time.	39
Figure 47. Positioning partial-beam shotcrete molds and containment fixtures prior to shotcreting.	40
Figure 48. Portable test machine for determining early-age strength of shotcrete.	41
Figure 49. Loading of partial-beam shotcrete sample during an early strength test.	41
Figure 50. Shotcrete sample showing exposed failure plane.....	42
Figure 51. Early-age compressive strength versus curing time for partial-beam samples of K1 shotcrete with 1 to 6 hours of curing time.....	43
Figure 52. Schematic of overcoring and direct-tension test equipment for determining shotcrete adhesion strength.....	45
Figure 53. Operation of overcoring and direct-tension test equipment.....	45
Figure 54. Tensile loading of shotcrete core sample to determine bond strength.	45
Figure 55. Wet drilling with diamond core bit.....	47
Figure 56. Drill hole configuration with extension rod connected to epoxied stud.	48
Figure 57. Schematic showing a vertical cross-section of the drill hole configuration for a shotcrete bond strength test.....	48
Figure 58. Strap brackets centered around the epoxied stud to anchor the direct-tension test equipment.	49
Figure 59. Pulling unit mounted to mine rib using a three-point safety restraint.....	50

Figure 60. Typical shotcrete tensile strength test results for 0–90 day cure time (n=54).....	50
Figure 61. Shotcrete test core and drill hole from a bond strength test with dry mix shotcrete applied to a concrete substrate.	52
Figure 62. Shotcrete adhesion test site with three drill stands mounted on mine rib.....	53
Figure 63. Dry drilling the installation hole for the epoxied stud pull anchor.....	53
Figure 64. Wet drilling a 102-mm (4-in) diameter hole for the shotcrete adhesion test core (note bit change).....	53
Figure 65. Preparing to remove drill stand and install direct-tension test equipment.	54
Figure 66. Adhesion test #1: core broke in shotcrete and at interface between two shotcrete layers.....	55
Figure 67. Adhesion test #2: core broke entirely in the top layer of shotcrete.....	55
Figure 68. Adhesion test #3: core broke prematurely in weak underlying host rock.....	55
Figure 69. Adhesion test #3: drill hole and core indicating a tensile failure located primarily in the host rock.....	56
Figure 70. Test core #3: tensile failure in weak host rock.....	56
Figure 71. Adhesion test cores showing two breaks in shotcrete (left, test 1 and middle, test 2), and one break in host rock (right, test 3).	56
Figure 72. Diagram of the force applied to a round-panel shotcrete sample during an RDP test.	58
Figure 73. Schematic of a portable round determinate panel (RDP) test machine developed by NIOSH researchers.....	61
Figure 74. Operation of portable round determinate panel (RDP) test machine.....	61
Figure 75. Mold ring used to prepare a round-panel shotcrete sample.....	62
Figure 76. Sprayed round-panel shotcrete samples.....	63
Figure 77. Round-panel shotcrete sample positioned in portable RDP test machine.....	63
Figure 78. Broken round-panel test sample showing tension cracks.....	64
Figure 79. Synthetic macro fibers exposed along the failure surface of round-panel shotcrete sample.....	64
Figure 80. Broken round panel sample of fiber-reinforced shotcrete showing the 120° cracks. .65	65
Figure 81. Typical roof bolt pattern with a superimposed RDP test panel showing the assumed flexural loading of the shotcrete between the bolts.....	65
Figure 82. Load versus displacement curve from RDP test.....	66
Figure 83. Load versus displacement curve from RDP test indicating peak load and first break.....	67
Figure 84. Load versus displacement curve from RDP test indicating peak load, residual load, and the energy or toughness of the shotcrete.....	67
Figure 85. Energy versus displacement curve from RDP test.....	68
Figure 86. Spraying round-panel shotcrete samples reinforced with wire mesh.....	69
Figure 87. Spraying round panel forms with a dry mix shotcrete.....	70

Figure 88. Comparison of load versus displacement curves for SCACR shotcrete mixed with well water and cured for 8 hours.	71
Figure 89. Comparison of load versus displacement curves for SCACR shotcrete mixed with mine water and cured for 8 hours.	71
Figure 90. Comparison of load versus displacement curves for SCACR shotcrete mixed with well water, reinforced with wire mesh, and cured for 28 days.....	72
Figure 91. Spraying round panel forms with wet mix shotcrete.....	73
Figure 92. Swing-type, positive-displacement pump used to apply wet mix shotcrete.	73
Figure 93. Comparison of load versus displacement curves for 295-kg (650-lb) mix with 24-hour cure time.....	74
Figure 94. Comparison of load versus displacement curves for 318-kg (700-lb) mix with 24-hour cure time.....	74
Figure 95. Load versus displacement and energy versus displacement curves for 5-kg/m ³ (8.5-lb/yd ³) Shogun fiber mix with 7-day cure time.	76
Figure 96. Shooting wet mix shotcrete into a round panel form with wire mesh reinforcement. .	77
Figure 97. Comparison of load versus displacement and energy versus displacement curves for 1.87-kg/m ³ (3.15-lb/yd ³) Shogun fiber mix with 28-day cure time.	81
Figure 98. Comparison of load versus displacement and energy versus displacement curves for 2.99-kg/m ³ (5.0-lb/yd ³) Shogun fiber mix with 28-day cure time.	81
Figure 99. Comparison of load versus displacement and energy versus displacement curves for 4.1-kg/m ³ (7.0-lb/yd ³) Shogun fiber mix with 28-day cure time.	82
Figure 100. Comparison of load versus displacement and energy versus displacement curves for shotcrete reinforced with six-gauge wire mesh and cured for 28 days.	83
Figure 101. Comparison of load versus displacement and energy versus displacement curves for shotcrete with a water-reducing admixture that is reinforced with six-gauge wire mesh and cured for 28 days.....	83
Figure 102. Comparison of load versus displacement and energy versus displacement curves for 1.87-kg/m ³ (3.15-lb/yd ³) Performax fiber mix with 28-day cure time.	84
Figure 103. Comparison of load versus displacement curves for round-panel shotcrete samples reinforced with synthetic macro fiber (polyfiber), steel fiber, or wire mesh.....	87
Figure 104. Comparison of load versus displacement and energy versus displacement curves for round-panel shotcrete samples reinforced with synthetic macro fiber (polyfiber), steel fiber, or wire mesh.	88
Figure 105. Estimated support categories based on tunneling quality index Q.....	90

Tables

Table 1. Summary of all fatalities and injuries in underground metal mines, 2006–2010 (operator and contractor cases)	4
Table 2. Typical water-to-cement ratios for shotcrete	24
Table 3. Typical mix designs for steel-fiber-reinforced shotcrete with silica fume additive	26
Table 4. Typical range of shotcrete early strength and re-entry time by region.....	34
Table 5. Early strength test results for partial-beam shotcrete samples using the NIOSH portable test machine.....	42
Table 6. Typical indicators of the quality of a shotcrete application obtained through a careful examination of the test core and drill hole	46
Table 7. Typical range for shotcrete bond strength with differing substrates	46
Table 8. Shotcrete adhesion test results	54
Table 9. Typical minimum load capacity values specified for shotcrete in recent mining and civil engineering projects in North America for given ground support conditions and RDPT ram displacements.....	59
Table 10. Typical values specified for shotcrete toughness in recent mining and civil engineering projects in North America for given ground support conditions	60
Table 11. Comparison of shotcrete toughness performance level to Q-system rock class, RDPT energy, ground support reinforcement category, and RMR for recent mining projects in North America	60
Table 12. Proportions of various mix constituents for round-panel shotcrete samples at the Devil's Slide Tunnels Project.....	75
Table 13. Proportions of various mix constituents for round-panel samples of reinforced shotcrete at the Leeville Mine.....	78
Table 14. Average results from field tests with round-panel shotcrete samples.....	85
Table 15. Summary of shotcrete applications in underground mining for different rock mass conditions.....	91
Table 16. Recommended frequency of shotcrete tests for mining applications.....	93
Table 17. Typical corrective actions for shotcrete problems	94
Table A1. Early strength test machine.....	105
Table A2. RDP test machine	106
Table A3. Overcoring and direct-tension test system	106

ACRONYMS AND ABBREVIATIONS

ACI	American Concrete Institute
ASTM	American Society for Testing and Materials
BASF	Registered logo of BASF, The Chemical Company
CRF	cemented rockfill
EFNARC	European Federation of National Associations Representing Concrete
ESR	Excavation support ratio
MSHA	Mine Safety and Health Administration
NATM	New Australian Tunneling Method
NDL	no days lost
NFDL	nonfatal days lost
OMSHR	Office of Mine Safety and Health Research
PLC	programmable logic controller
RDP	Round determinate panel
RDPT	Round determinate panel test
RMR	Rock Mass Rating
SCA	Superstick with water accelerant
SCACR	Superstick water accelerant with corrosion resistance
SCAPF	Superstick water accelerant and polyfiber
SCAPT-100	Superstick water accelerant and steel fiber
SCAR	Superstick water accelerant with retarder
TPL	toughness performance level
UCS	unconfined compressive strength
w:c	water-cement ratio

UNIT OF MEASURE ABBREVIATIONS

cfm	cubic feet per minute
m ³ /m	cubic meter per minute
ft	feet
in	inch
in/min	inches per minute
kg	kilogram
kg/m ³	kilogram per cubic meter
kN	kilonewton
L	liters
m	meter
mm	millimeter
mm/min	millimeter per minute
min	minute
MPa	megapascal
%	percent
lb	pound
lbf	pound force
lb/ft ³	pounds per cubic foot
lb/yd ³	pounds per cubic yard
psi	pounds per square inch
qt	quart

Shotcrete Design and Installation Compliance Testing: Early Strength, Load Capacity, Toughness, Adhesion Strength, and Applied Quality

Lewis A. Martin,¹ Curtis C. Clark,² Joseph B. Seymour,³ and Michael A. Stepan⁴

Executive Summary

The National Institute for Occupational Safety and Health (NIOSH) conducted a research study to document and develop safe practices for the use of shotcrete as ground support in underground mines, particularly in underground metal mines operating in weak host rock. Shotcrete is the generic name for a mixture of cement, sand, fine aggregate, and water that is applied pneumatically and compacted dynamically under high velocity. The objective of this research is to reduce mine worker fatalities and injuries resulting from rockfall accidents. Although the information, techniques, and technology covered in this publication will impact both the mining and construction sectors, the primary audience is the mining industry with a focus on underground metal mines operating in weak ground conditions. The information and practices covered in this publication relating to the use of shotcrete can be put to use by mining professionals towards improving mine design and ground control plans. The guidance and practices reported in this document will help safety auditors, mining companies, and shotcrete suppliers in improving their shotcrete product specifications and the performance of ground support systems, evaluating ground control plans, and assessing shotcrete quality control. Ground control safety can be improved by providing these groups with a better understanding of the use of shotcrete in weak rock conditions, field test methods and equipment for measuring the strength properties of shotcrete directly at the mine site, and a practical means of conducting quality control during shotcrete applications.

Development of Portable Test Machines

NIOSH researchers developed three portable test machines for determining shotcrete strength properties directly at the mine site. These portable test machines can be used to measure the early-age compressive strength of the shotcrete, the flexural load capacity and toughness of the shotcrete, and the installed quality and bond strength of the shotcrete that is applied to underground entries; this enables the test machines to be used to verify safe re-entry times. Onsite testing of as-placed shotcrete allows the mine personnel and shotcrete supplier to determine if the shotcrete is performing to design specifications. Using these shotcrete test

1 Research Mechanical Engineer, Ground Control Branch, Office of Mine Safety and Health Research (OMSHR), NIOSH, Spokane, WA.

2 Mechanical Engineer, Ground Control Branch, Office of Mine Safety and Health Research (OMSHR), NIOSH, Spokane, WA.

3 Mining Engineer, Ground Control Branch, Office of Mine Safety and Health Research (OMSHR), NIOSH, Spokane, WA.

4 Engineering Technician, Ground Control Branch, Office of Mine Safety and Health Research (OMSHR), NIOSH, Spokane, WA.

machines directly at a mine site allows the support capabilities of the shotcrete to be evaluated in terms of the specific ground conditions, support methods, mining spans, and entry dimensions at the mine. As a result, mine design decisions regarding the use of shotcrete can be made from a much more informed position. Ultimately, this enhanced onsite knowledge of shotcrete strength properties and the quality of shotcrete application techniques can result in better ground support system designs and procedures, thereby reducing the number of fatalities and injuries associated with groundfall accidents.

Shotcrete Characteristics and Application

When the shotcrete is applied in-cycle to underground mine surfaces as part of the ground support system, it becomes important to quantify when mining can safely resume under the material. As part of the overall ground support system, shotcrete is typically sprayed on the surface of an underground opening to stabilize the ground and prevent raveling. Shotcrete is also applied at lower water-to-cement ratios than concrete and develops its own unique strength characteristics. In addition, the quality of the applied shotcrete, the competency of the underlying rock, and the load-carrying capability of the shotcrete once cured are of critical importance. The significant shotcrete characteristics examined in this report are: slump, compressive strength, tensile strength, early strength, adhesion strength, and flexural strength. Of these shotcrete characteristics the engineering strength properties that are determined using early strength, adhesion strength, and flexural strength testing methods are the focus of this report. The significant shotcrete tests to determine characteristics examined in this research study are:

- Slump Test – used to determine (wet) uncured shotcrete consistency.
- Compression Test – used to measure cured shotcrete compression strength.
- Tensile Test – used to measure cured shotcrete tensile strength.
- Early Strength Partial-beam Test – used to measure shotcrete cure strength development over time.
- Overcoring and Direct-tension Pull Test – used to measure cured shotcrete adhesion strength.
- Round Determinate Panel Flexure Test – used to measure cured shotcrete load capacity and toughness.

Introduction

Research Impetus and Report Contents

The National Institute for Occupational Safety and Health (NIOSH) Office of Mine Safety and Health Research (OMSHR) Ground Control Branch conducted investigations into the use of shotcrete as ground support in mines that have weak rock mass with the objective of reducing fatalities and injuries resulting from rockfall accidents. This Report of Investigations presents the results of efforts to document current shotcrete ground support system techniques for weak rock and to determine shotcrete application requirements. In addition, this report also identifies critical shotcrete strength parameters and presents methods for conducting mine-site measurements. Finally, this report describes the standards that are currently in use for the safe and effective application of shotcrete for support in weak rock. In reporting these findings, the hope is that this information will become more widely accepted and implemented by the mining and safety community.

Shotcrete and Weak Rock

Shotcrete is sprayed concrete consisting of cement, sand, and fine aggregate that is applied pneumatically and compacted dynamically under high velocity. Shotcrete has been used to construct support structures in civil engineering applications for nearly 100 years and for support in underground mining excavations for at least 40 years [Morgan 2008; Spearing 2001]. The underground metal mining industry is a major user of shotcrete for engineered underground support and has pioneered novel applications using shotcrete. The demand for support systems that can accommodate the extreme underground loadings of weak rock mass, defined as having a rock mass rating (RMR) from 20 (very poor) to 45 (poor), is being met with the incorporation of shotcrete into a multi-element ground control system consisting of shotcrete, welded wire mesh, and plated bolts. The use of shotcrete is an essential factor in the success of this support system, and when combined with welded wire mesh, this composite system is superior to either welded wire mesh or fiber-reinforced shotcrete alone in low RMR ground mining conditions. When used as an essential component of the ground support system, shotcrete is applied during the active mining cycle, and as such, monitoring the application quality, early strength gain, and long-term support characteristics of the material is very important.

Shotcrete Quality Monitoring for Safety

In order for the mining cycle to resume safely after the application of shotcrete, under which the miners and machinery will be working, the shotcrete must first reach a self-supporting state or strength. NIOSH has undertaken the study of how this shotcrete performance is defined and how the performance can be determined or monitored in the field. Mine staff must have a means of quantifiably determining the shotcrete strength after application to keep their mine safe for their workers and equipment.

Researchers at NIOSH developed shotcrete material testing machines that are used at the mine site to assist mines in determining if the shotcrete used in the ground control support system is meeting the specified shotcrete performance requirements. These portable, mine-site testing machines measure early compressive strength related to re-entry time (amount of time that elapses before mine workers can safely re-enter an area of the mine), flexural load capacity, toughness, installed quality, and bond strength.

Background

Ground Control and Rockfalls

As noted by Seymour et al. [2013], rockfalls or groundfalls are a serious hazard in underground metal mines. From 2006 through 2010, groundfalls caused 50% of the fatalities, 13% of the nonfatal days lost (NFDL) injuries, and 15.9% of the no days lost (NDL) injuries that occurred in underground metal mines (Table 1). During this time period, groundfall accidents were the leading cause of fatalities in underground metal mines and also an important contributing factor in the injuries that were reported by the Mine Safety and Health Administration (MSHA) for the underground metal mining workforce.

Table 1. Summary of all fatalities and injuries in underground metal mines, 2006–2010 (operator and contractor cases) after Seymour et al. [2013]

Type of Accident	Fatal injuries	Nonfatal days lost injuries	No days lost injuries	Total injuries
All accident classifications	14	923	579	1,516
Groundfalls	7	120	92	219
Groundfall percentage	50.0%	13.0%	15.9%	14.4%

As shown in Figure 1, groundfalls were the third highest ranking source of lost-time injuries in underground metal mines from 2006 through 2010. These statistics indicate that ground control is an extremely challenging issue in underground metals mines and that further ground support research is needed to address this problem. Because many of these groundfalls occur between traditional ground support elements (e.g., bolts, trusses, timber, etc.), improvements in support methods that provide surface control, such as shotcrete and wire mesh, could be expected to reduce the number of groundfalls and thus, potentially decrease the number of fatalities and injuries associated with these accidents.

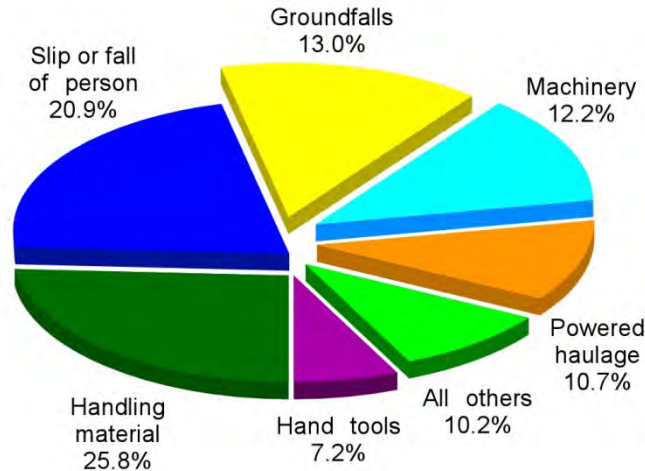

Figure 1. Distribution of lost-time injuries in underground metal mines by accident class, 2006–2010 (operator and contractor cases) after Seymour et al. [2013].

Weak Rock Conditions

Nevada surface gold mine operations started driving underground access tunnels in the early 1990s to develop their underground gold reserve properties. These high-grade Nevada gold deposits are exceptional in that they are found predominantly in argillized fault and fracture zones; the deposits are often large and irregularly shaped and are surrounded by waste rock of similar characteristics. The ore-bearing rock exhibits high deformation under loading. The geologic conditions of the rock are unique with poor-quality raveling rock in some areas (Figure 2) and highly deformable intrusions and foliations that can be gouged out by hand in others (Figure 3). In addition, the country rock outside the ore zones is localized with unpredictable fracturing and is susceptible to groundfalls. The common factor in all the mines operating in these deposits is the presence of a weak back (roof) or walls. The definition of a weak rock mass in this context is an RMR of under 45 or a Q value under 1.0. Rock mass values that have been reported vary from an RMR high of 70 to a low of 16 in the gold-bearing fault gouge [Pakalnis 2008]. These unusual ground characteristics make mine openings particularly vulnerable to hazardous falls of ground.



Photos by NIOSH

Figure 2. Poor-quality, raveling rock in an underground gold mine in Nevada.



Photos by NIOSH

Figure 3. Poor-quality, highly deformable rock in an underground gold mine in Nevada.

Weak Rock Mining Method

The mining method commonly used in the weak rock underground gold mines is a modified form of mechanized cut-and-fill that works well to achieve high ore recovery rates in deposits with irregular geometries. In order to mine safely in weak rock mass ground conditions, mining operations have developed support methodologies that use extensive ground support and backfill. In general, the method is for production stopes to be mined under the host rock on the top cuts or upper levels, followed by further mining on lower levels under cemented rockfill (CRF). The mine openings (drifts) are typically less than 4.6-m (15-ft) wide and 3 to 4.6-m (10 to 15-ft) high and mined with short 3-m (10-ft) blast rounds. In some instances, the drifts need only remain open for as little as 3–5 days.

The ground control support used in the top-cut of weak rock mines is installed concurrently during the active mine cycle. The initial ground support consists of a shotcrete flash coat, followed by welded wire mesh, plates, installation of short bolts, and a second layer of encapsulating shotcrete. Deep support bolts with plates are then installed through the shotcrete welded wire mesh matrix to complete the support system during the final shotcrete phase as shown in Figure 4. After the top-cut ore has been removed, the top cut is backfilled with cemented rockfill. Subsequent levels are mined under the cemented rockfill (CRF), as noted by Seymour et al. [2013].



Photo by NIOSH

Figure 4. Final in-cycle application of wet mix shotcrete.

Typical Top-Cut Mining Cycle for Weak Rock

The top-cut mining method starts with a series of drifts that are driven into the upper level of the orebody using a jumbo drill. The blastholes are typically drilled to a depth of 3 m (10 ft) and then loaded for a blast round. These top-cut drifts are typically small in size because of the poor rock quality and geologic structure present in the ore zone (Figure 5).

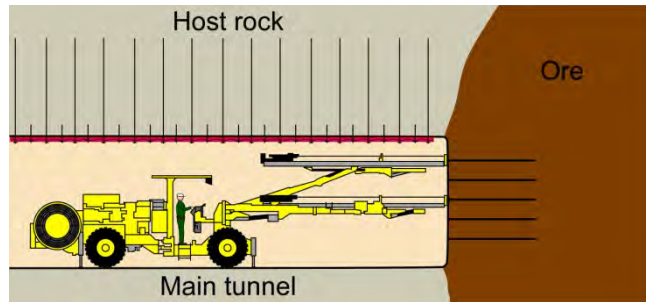

Figure 5. Drilling the first blast round.

The blast round is then removed. The rounds are designed to break the rock and advance the drift an additional 3 m (10 ft). Drill hole spacing and explosive load are carefully manipulated to minimize damage to the surrounding rock (Figure 6).

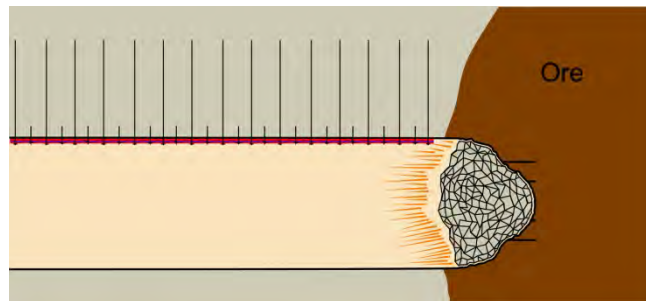

Figure 6. Blasting the first round.

Following the blast, a shotcrete machine equipped with a remote-controlled manipulator arm is used to spray an initial layer of shotcrete (flash coat) onto the mine roof and walls to stabilize the ground and prevent raveling (Figure 7).

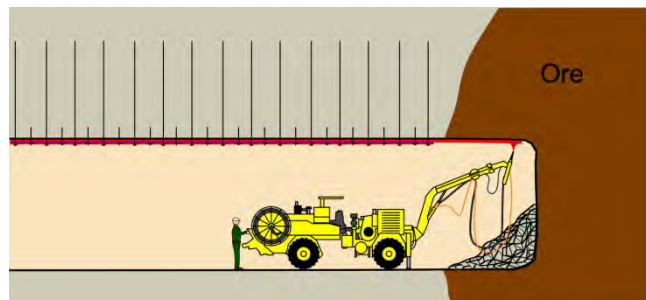

Figure 7. Applying first layer of shotcrete.

The blasted ore is then removed with a mucker operating under supported roof (Figure 8). This clears the drift of broken rock so that other equipment can be used to install the remaining ground support components, including bolts and welded wire mesh.

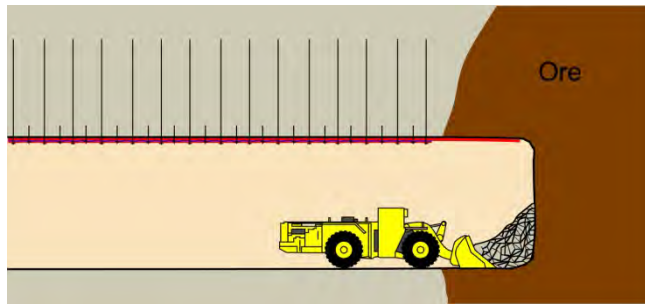

Figure 8. Removing blasted rock or muck with loader.

A roof bolting machine is then used to install short, secondary bolts and welded wire mesh over the first layer (flash coat) of shotcrete (Figure 9).

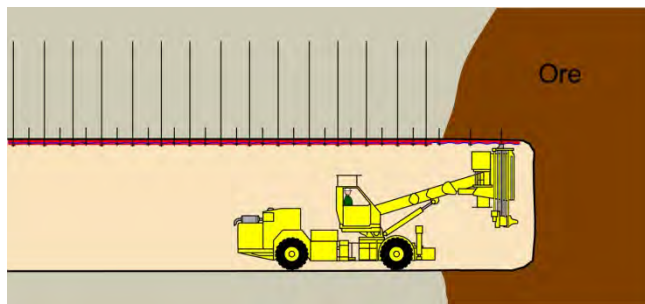

Figure 9. Installing short bolts and welded wire mesh.

The next 3-m (10-ft) blast round is then drilled using a jumbo drill (Figure 10).

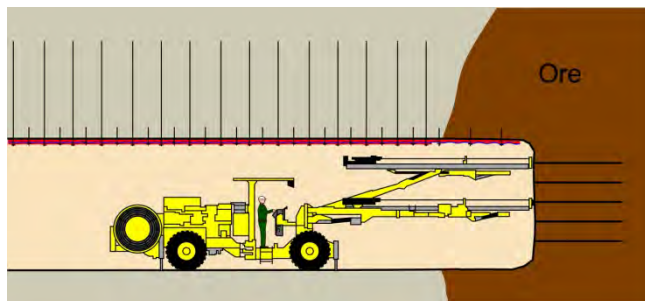

Figure 10. Drilling a second blast round.

Following a second blast, the drift is advanced an additional 3 m (10 ft) past the secondary ground support (short bolts, welded wire mesh, and flash coat of shotcrete) that was installed in the previous advance (Figure 11).

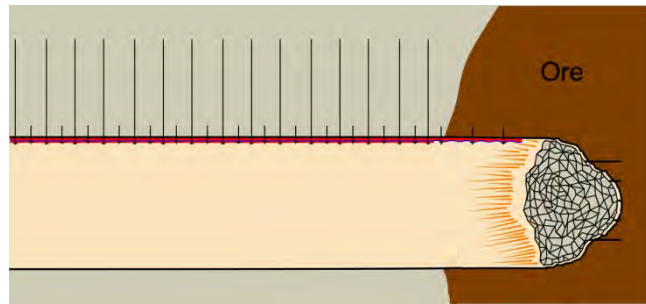

Figure 11. Blasting the second round.

The shotcrete machine is then used to apply a second layer (final coat) of shotcrete over the short bolts and welded wire mesh installed in the previous advance as well as a flash coat of shotcrete over the rock surface exposed by this blast (Figure 12).

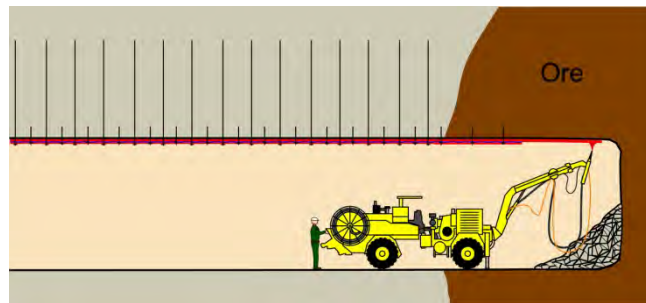

Figure 12. Installing a second layer of shotcrete.

The mucker operating under supported roof is again used to remove blasted ore from the drift, providing access for the roof bolting machine to install additional ground support (Figure 13).

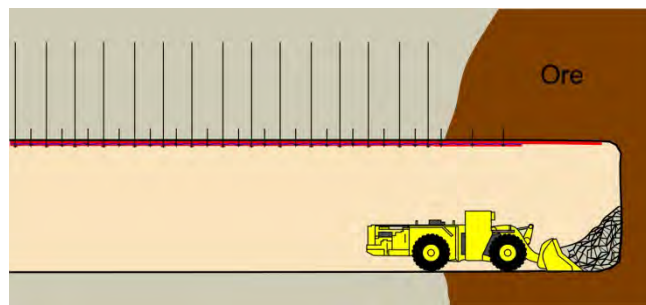

Figure 13. Removing blasted rock or muck with loader.

Next, a roof bolting machine is used to install long bolts through the supermesh created by the short bolts, welded wire mesh, and shotcrete layers. These longer bolts provide the primary ground support by preventing large blocks of ground from falling into the drift (Figure 14).

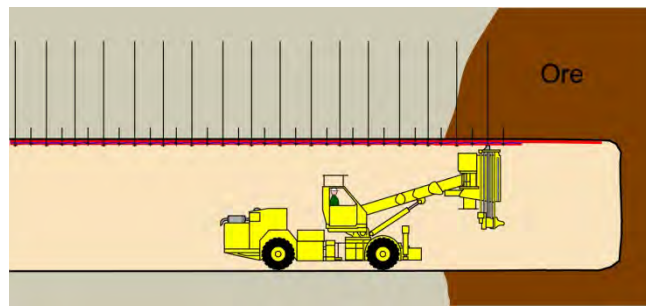

Figure 14. Installing long primary bolts.

This completes the ground support cycle, as the roof bolting machine is once again used to install welded wire mesh and short bolts over a flash coat of shotcrete (Figure 15).

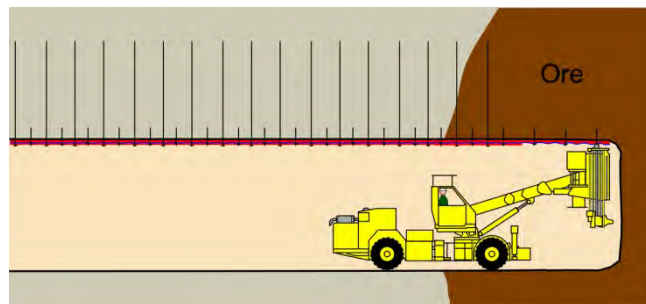

Figure 15. Installing short bolts and welded wire mesh.

Application and Use of Shotcrete for Surface Control in Weak Rock

Support System

The squeezing and raveling rock encountered in weak ground is not self-supporting after excavation and consequently, the support system must be installed concurrently with the active mining cycle, as previously mentioned. In the ground control system, shotcrete is used to provide temporary surface control for local stability before the primary support is installed. Because the shotcrete must become self-supporting before miners and equipment can work safely underneath, the curing characteristics of the shotcrete are critical to the speed of the mining cycle.

Initially, a thin layer of shotcrete is applied as surface control to prevent the rock from unraveling (Figure 16). The flash coat is 19 to 25-mm (0.75 to 1-in) thick. This thin layer of shotcrete stabilizes the newly exposed surface and prevents very small rock and debris from falling, and also prevents air slacking and dehydration of the rock material exposed in the cracks. If this material is not confined, the small-sized rock can loosen and fall out, allowing additional material to displace, which compromises the geometric structure, ultimately causing massive failure [Bauer and Donaldson 1992].

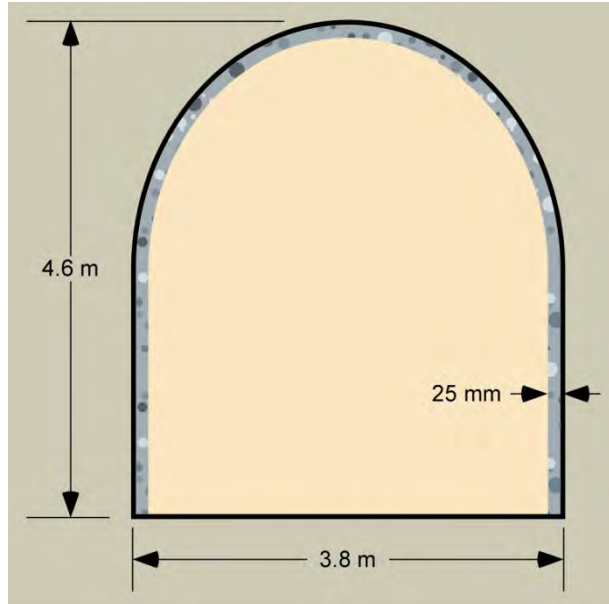

Figure 16. Application of a thin initial layer or flash coat of shotcrete.

Next, a 100 x 100 mm (4 x 4 in) six-gauge welded wire mesh is prepositioned, and friction bolts with plates are installed to hold the mesh in place. This prevents unraveling of the rock and will temporarily stabilize the ground between the future primary support locations (Figure 17). The plated short bolts also reduce vibration as the second shotcrete layer is applied to the welded wire mesh. It must be recognized that the weak rock mass will likely unravel, and the result will be the individual rock blocks falling from between the bolts; therefore, surface support is required to contain the rock mass as a single support unit [Pakalnis 2010].

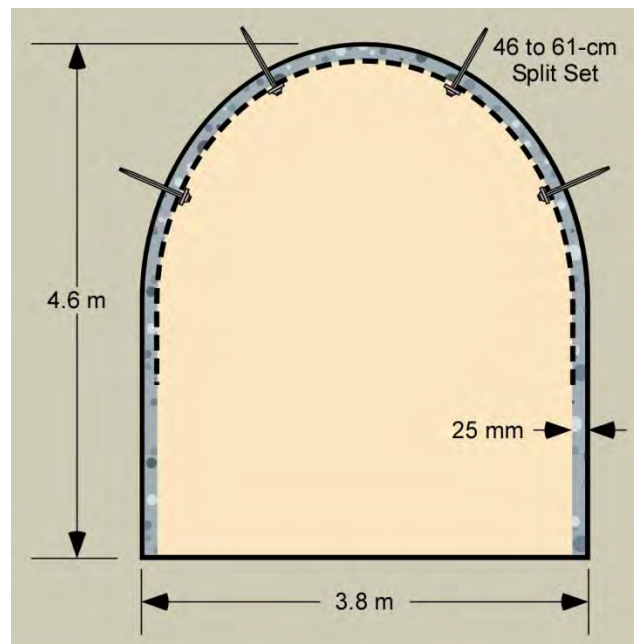

Figure 17. Installation of welded wire mesh, plates, and short bolts.

The primary ground support is then installed through the supermesh. This consists of long Swellex™ roof bolts (from Atlas Copco, Minova) with plates and either 0.9-m (3-ft) friction bolts or 1.8-m (6-ft) Swellex bolts, depending on the rock mass rating. A view of the completed ground control system is shown in Figure 19.

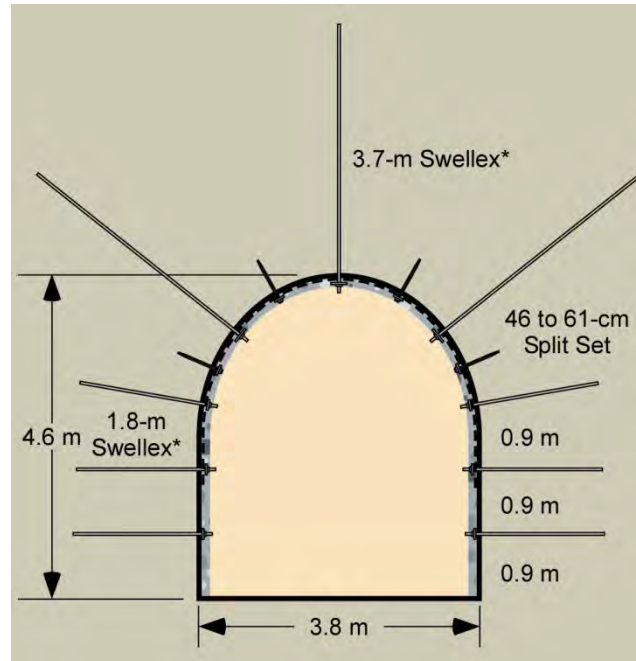

Figure 19. Completed ground control system with plated, long primary bolts through the matrix and shorter bolts to the springline.

Installing the primary support bolts through the supermesh provides a ground support system that has capabilities not provided by the use of mesh or shotcrete alone. Finally, for the ribs, 0.9-m-long (3-ft-long) bolts or 1.8-m-long (6-ft-long) bolts with plates are installed depending on the RMR (if RMR is < 45, then 1.8-m (6-ft) bolts are installed to support the rib area of the opening). The long roof bolts are required to stabilize the opening while the supermesh serves to keep the small rocks from falling between the bolts.

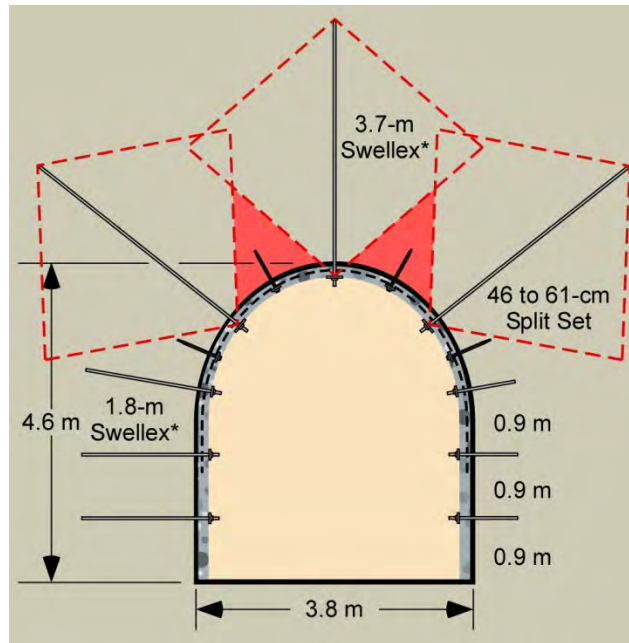

Figure 20. Multi-element ground support system for weak rock.

The support profile of a mine opening using the supermesh multi-element ground control system is shown in Figure 20. The local support provided by the supermesh and short bolts is shown by the red load cones (small red wedges). The supermesh provides local surface control holding the rock mass together and enabling the ground support load to be transferred back to the primary supports, the long bolts. Even after the shotcrete begins to develop cracks and dislodge, it still provides residual structural support because of the wire mesh embedded within the shotcrete. The global support provided by the primary bolts is represented by the diamond-shaped load cones, shown in Figure 20 as dotted lines. The compression arch formed by the long rock bolts is the primary structural support and has the greatest influence on stabilizing the mine opening and preventing failure [Kaiser and Tannant 2001].

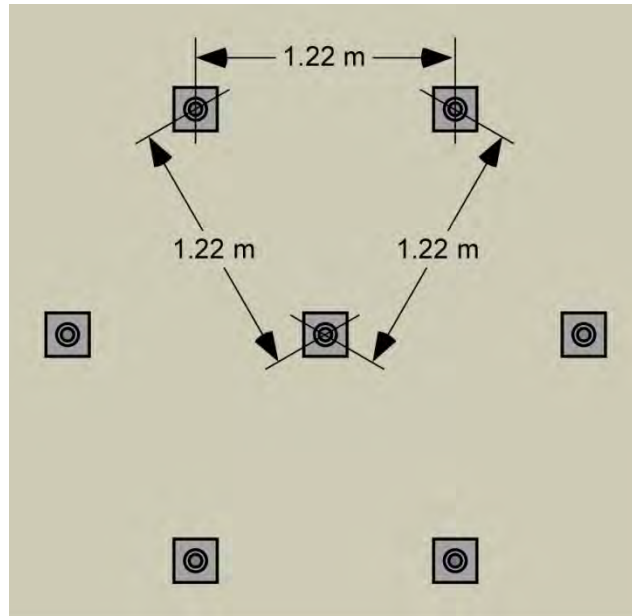

Figure 21. Plan view of primary bolt pattern, looking up at the back from below.

The long primary support bolts are installed on a defined bolt spacing pattern along the roof arch of the opening (Figure 21). The bolt length and spacing are determined by ground control experts using the appropriate empirical methods. In general, the bolt length and spacing are based on the height of a wedge of the material the bolts must support. Pakalnis [2008] observed and reported that the depth of failure in the absence of structural support will be equal to one-half the opening span.

Shotcrete Failure Modes

Unsupported, unreinforced shotcrete applied to underground mine openings fails primarily when there is a loss of contact with the underlying substrate. This is followed by a subsequent failure in flexure as the shotcrete bends under the weight of additional loading from loose material (Figure 22) [Barrett and McCreath 1995; Holmgren 2001]. Failure of the shotcrete can be caused by a loss of adhesion with the rock surface or from the rock itself losing contact with adjacent rock. There are two basic types of shotcrete failure modes: fallout of only shotcrete indicating poor adhesion and fallout of shotcrete and rock, indicating zones of weak rock (Figure 23) [Malmgren and Svensson 1999].

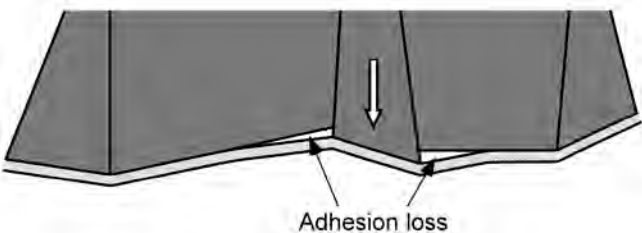

Figure 22. Flexural failure of shotcrete resulting from insufficient adhesion strength, after Kuchta [2002].

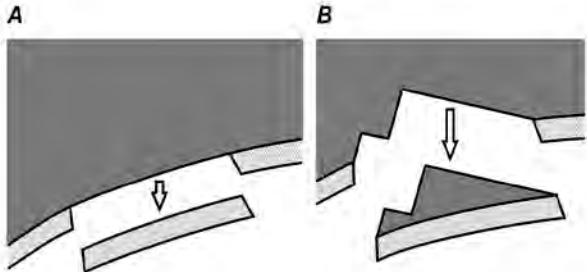

Figure 23. Two basic types of shotcrete failure modes: A – fallout of only shotcrete and B – fallout of shotcrete and rock, after Malmgren and Svensson [1999].

When shotcrete is used in conjunction with roof bolts, several other failure modes are possible as shown in Figure 24.

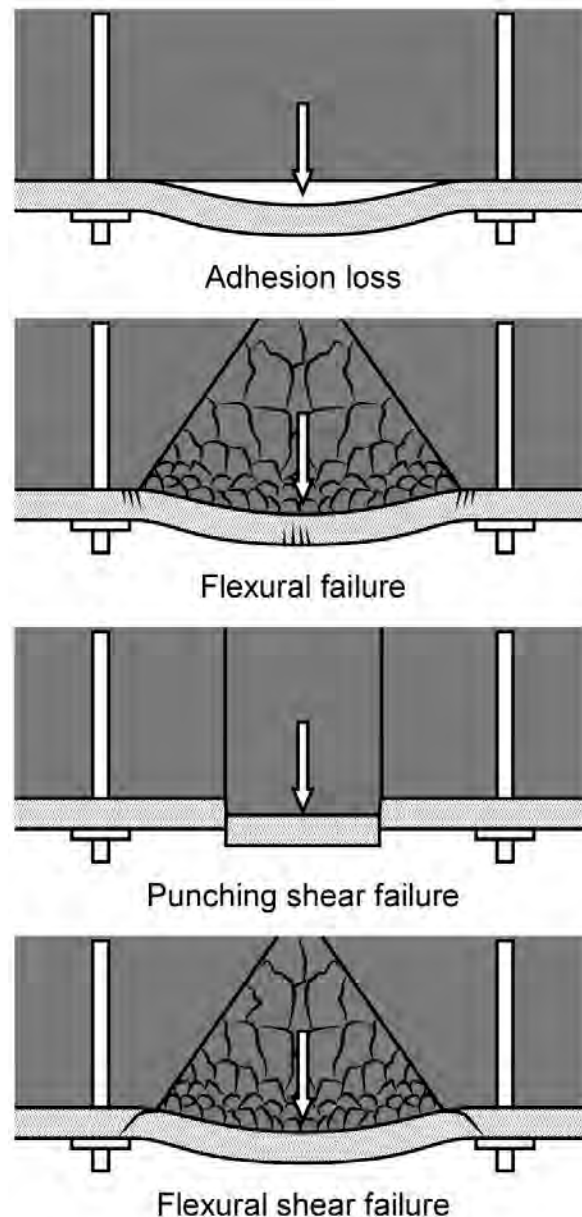

Figure 24. Schematic of shotcrete loading and failure modes, after Morton et al. [2008], Barrett and McCreath [1995].

Post Deformation Strength

The inclusion of welded wire mesh reinforcement with shotcrete produces a product with redundant ground support capabilities in the event the rock mass loading exceeds the capacity of the shotcrete and cracking occurs. The combination of shotcrete and welded wire mesh creates a support structure with sufficient flexural stiffness to provide good rock confinement, displacement prevention, and load-transfer properties back to the primary supports. The welded

wire mesh stabilizes the matrix and continues to provide support through large displacements. The supermesh can deform while still providing surface control by retaining a sufficient load-carrying capacity after cracking or failure of the shotcrete (Figure 25) [SRSUM 1999].

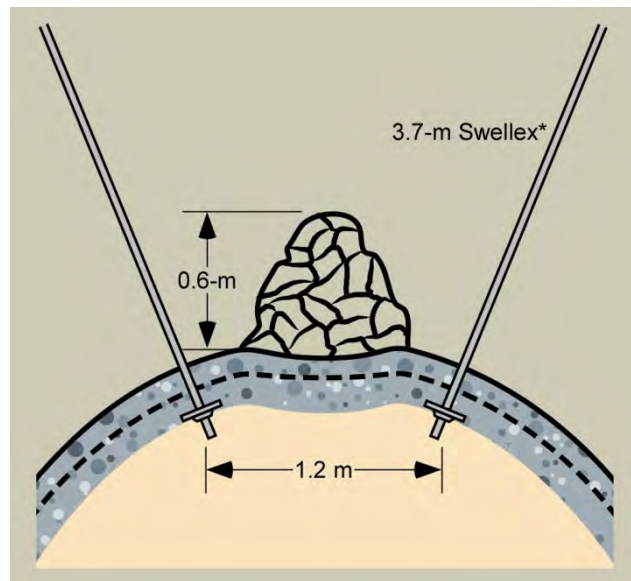

Figure 25. Supermesh provides support between the primary bolts.

Supermesh is better able to withstand the types of shotcrete failure mechanisms previously described than shotcrete alone. Figure 26 shows the loading of a multicomponent ground control system in weak rock and the types of failures that can be prevented through the addition of welded wire mesh. The red arrow indicates the plated bolts placed through the supermesh, and the orange grid represents the blocky ground mass.

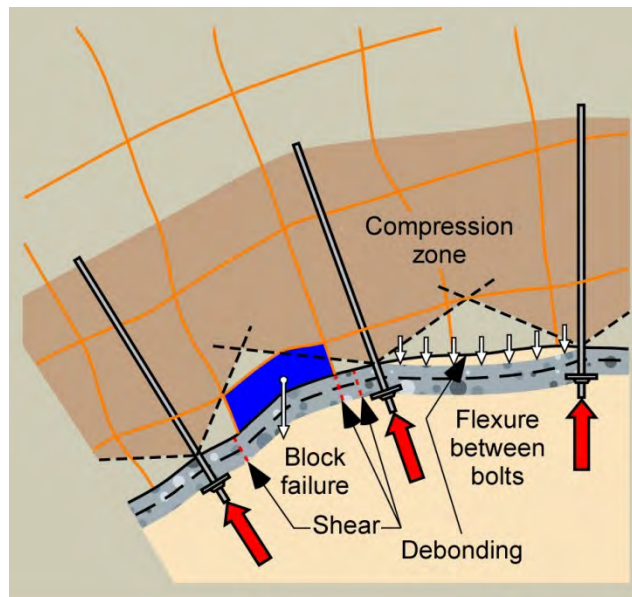

Figure 26. Shotcrete failure modes that can be prevented by the addition of welded wire mesh.

Shotcrete Parameters

Shotcrete Mix Types

This section contains important information about shotcrete and brief descriptions of shotcrete mix types. The Australian Shotcrete Society [AuSS 2008] provides excellent in-depth coverage of the shotcrete topic and was used heavily in developing the content in the following sections of this document. Every effort was made to credit the original source material.

Shotcrete is an engineered product composed of a mixture of cement, sand, fine aggregates, and admixtures. Admixtures are used to influence spray ability, adhesion, curing time, and cured strength or toughness. These admixtures come in the form of micro silica, accelerators or retarders, plasticizers, and reinforcing components (fibers) [Kaiser and Tannant 2001]. Shotcrete is available as either a wet mix or a dry mix product with the constituent ingredients preformulated in the correct proportions by the supplier. Shotcrete can be batched onsite or delivered from the supplier via mix truck.

Shotcrete can be sprayed using either a wet or dry process. After an initial curing time of 24 hours, the final installed product has very similar strength properties regardless of the mix type process. A number of factors influence the type of shotcrete that is used at a particular mine site, including the size of the mine opening, quantity of material that must be applied, physical layout and spacing of the workings, available surface support operations, and other considerations [Morgan 2008].

Dry Mix Shotcrete

The dry mix shotcrete system uses smaller equipment and requires less capital costs than a wet mix shotcrete system. Because the equipment is smaller and mobile, the dry system can be used in all areas. However, dust from dry mix shotcrete can be a problem. The shotcrete components, which may be slightly predampened to reduce dust, are fed into a hopper with continuous agitation. Compressed air is introduced through a rotating barrel or feed bowl to convey the materials into a continuous stream through the delivery hose. Water is added to the mix at the nozzle (Figure 27 and Figure 28).

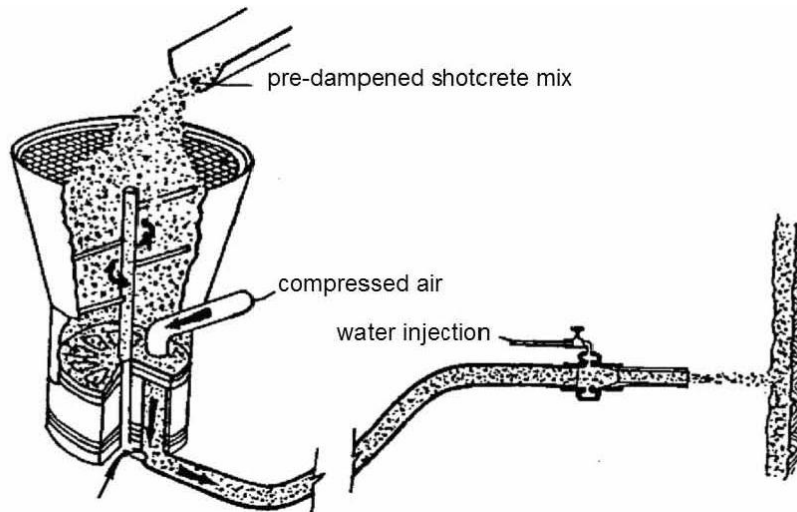

Figure 27. Simplified schematic of a typical dry mix shotcrete system, after Mahar et al. [1975].



Photo by NIOSH

Figure 28. Operation of a dry mix shotcrete machine equipped with a rotary barrel.

Wet Mix Shotcrete

The wet mix shotcrete system requires an extensive commitment in terms of capital expenditure and infrastructure. A batch plant for mixing shotcrete can be set up either on the surface or underground. For deep mines, a slick line is often used to transport the mixed shotcrete underground. Once the shotcrete is mixed, a shotcrete transport vehicle is used to deliver the shotcrete to the application site. In some cases, mix trucks are employed underground to batch and deliver the mix. The wet mix system typically has higher production rates than the dry mix process. Although there is less dust in the wet mix process, fogging is significant. After the batched wet shotcrete mix is delivered to the application site, the shotcrete mix is poured into a positive displacement pumping unit. The pump then delivers the wet mix hydraulically to the nozzle where air and an accelerator are added to spray the shotcrete onto the rock surface (Figure 29 and Figure 30).

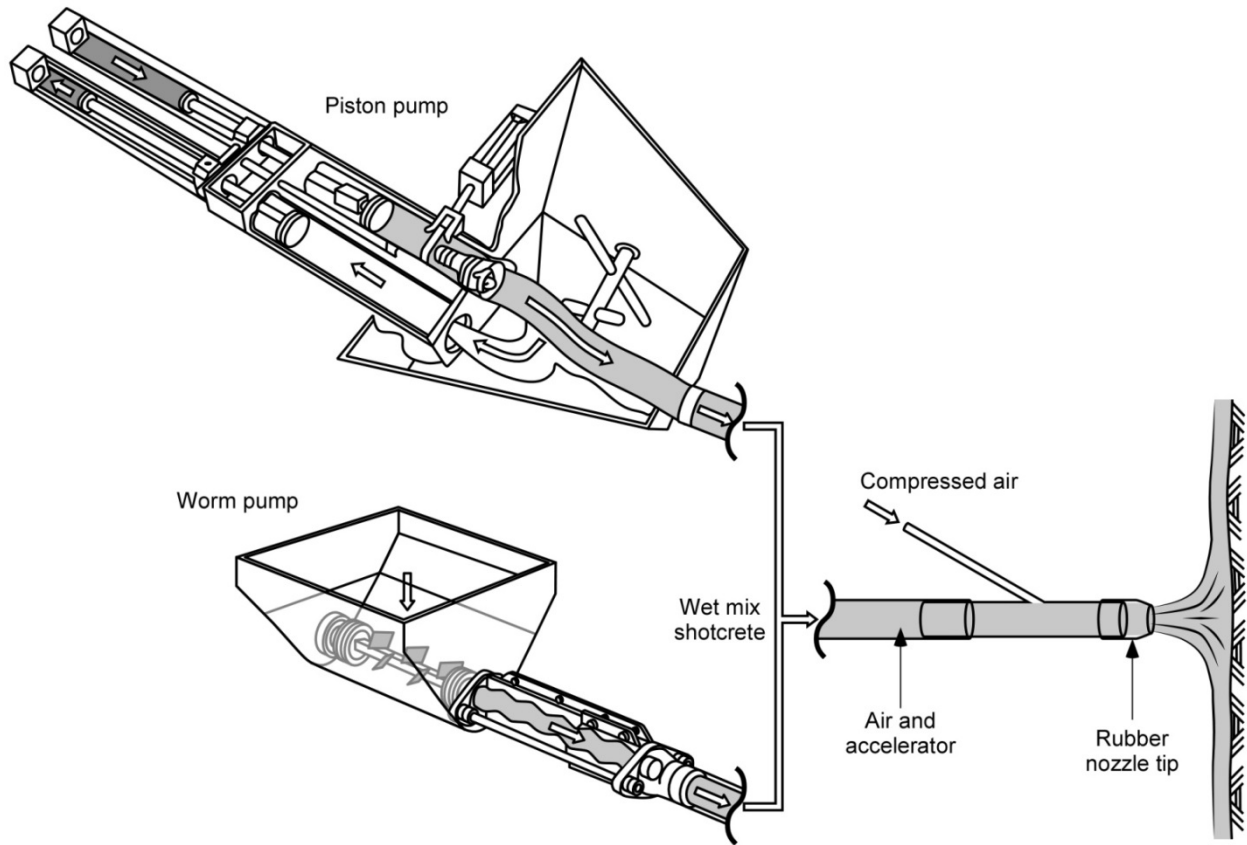

Figure 29. Simplified schematic of a typical wet mix shotcrete system, after Vandewalle [1993].



Photo by NIOSH

Figure 30. Operation of a wet mix shotcrete machine.

Shotcrete Mix Constituents

Cement

The cement used for wet or dry mix shotcrete is generally a Portland type I/II variety or a blended cement variation. In many cases the supplier/manufacturer will incorporate supplementary cementitious materials into the shotcrete.

Supplementary Cementitious Materials

One of the most frequently added materials to cement is fly ash. This material improves the material flow characteristics and workability of the mix and reduces cost of the cement because it is a substitute for a portion of the cement. The main characteristic of fly ash is that it produces good strengths when fully cured. Fly ash is supplied in two forms: (1) normal, which is finely divided, inorganic, pozzolanic material and (2) special grade, which is a more reactive, faster curing, and finer variety. Silica fume with finer grade and faster early curing characteristics is also used. Granulated iron produced from ground furnace slag is also used as an admixture in some instances to alter the set time or to impart chemical resistance to the cured material [AuSS 2008].

Aggregates

The source aggregate component of each engineered mix is specified along with defined grading curves and the amount of variation permitted. These factors are the responsibility of the supplier in cases of proportioned bag or bulk mixes. For onsite batching using source materials, the mix should have a consistent grading within the allowable variation [AuSS 2008].

Mixing Water

The water used to batch the shotcrete mix is an important component in terms of its effect on mixing, application, curing, and long-term strength development. The temperature, presence of mineralization, and/or acidity of the water can affect the shotcrete mix performance. The purity of the water used to batch and mix the shotcrete should be tested along with allowable temperature variations. Hot water will accelerate and cold water will delay the cementitious curing process. The presence of mineralization in some cases will interfere with the cementitious process as will acidity levels outside the range with which the mix was designed to work [AuSS 2008].

Water-to-cement Ratio

The water-to-cement (w:c) ratio of a shotcrete mix has a strong influence on drying characteristics, strength development, and long-term durability of the applied material. Water-to-cement ratio is obtained by dividing the total water weight by the cementitious materials' weight in the shotcrete mix. For dry mix shotcrete the standard ratio is 35%, and for wet mix shotcrete, the standard ratio is 45% (Table 2). Water dosage, in terms of using the correct amount of water to maintain the specified w:c ratio for the shotcrete mix when batching, is critical as it affects the curing and strength development of the material from initial placement through maturity. The materials' strength must increase to threshold levels in a short amount of time after application in order for miners and equipment to safely re-enter the heading and then, when fully cured, to reach a specified ultimate strength. Overwatering the mix when batching or spraying the shotcrete can reduce the proportion of cementitious materials, delay curing time, reduce the long-term strength gain, and produce a loss of adhesion at the application surface. Underwatering of the mix can

cause the delivery-application equipment to plug, resulting in a lack of adhesion of the material to the application surface, producing heavy rebound and segregation of the shotcrete mix, compromising the hydration process, and reducing the strength of the shotcrete [AuSS 2008].

Table 2. Typical water-to-cement ratios for shotcrete

Mix type and application process	Typical range, %
Dry mix shotcrete	35
Wet mix shotcrete	45

Chemical Admixtures

There are a number of chemical admixtures that can be used to change the transport, curing, and overall timing of the shotcrete application process. The addition of these products, though helpful in extending working time or improving the transport and application characteristics, can degrade the support performance of the shotcrete if not used properly. Water reducers may be used to accelerate or retard curing. Superplasticizers (high-range water reducers) allow for less water to be used while maintaining good transport and application characteristics. Using reducers results in higher strengths than a comparable mix that uses excess water to achieve the workability of the shotcrete. In applications where the mix must be batched and then transported considerable distances involving time delays, hydration control admixtures can be used to suspend the hydration process for a period of time. After delivery and prior to application, an accelerator can then be added to resume the hydration process. Shotcrete accelerators are also used in situations where adhesion is paramount. However, these accelerators can lower the final cured strength of the shotcrete [AuSS 2008]. Care should be taken to ensure that the amount of accelerator added at the nozzle does not adversely affect the design strength of the shotcrete.

Shotcrete Reinforcement Methods

Shotcrete can be reinforced through the use of embedded steel mesh or through the addition of fibers to the mix prior to application. Unreinforced shotcrete exhibits high strength characteristics in compressive loading but has very low tensile strength and ductility. Weak rock ground conditions subject the shotcrete to high tensile loads, and therefore additional reinforcement is often needed in the shotcrete.

Shotcrete Reinforced with Welded Wire Mesh

Shotcrete is applied to welded wire mesh that is positioned over a previously installed flash coat of unreinforced shotcrete. This embeds the mesh within the shotcrete matrix. The mesh also helps during shotcrete installation as it provides additional anchor surface area for the shotcrete to stick on and build up bulk.

In weak rock when tensile stresses cause the brittle shotcrete to fail, the ductile steel provides toughness (post-crack ductility) that can prolong and preserve the integrity of the structure. The type of wire mesh reinforcement (wire gauge, grid spacing, and weave style) required for structural purposes is determined by ground control experts using the appropriate empirical methods.

For weak rock conditions six-gauge, 100 x 100-mm (4 x 4-in) grid welded wire mesh is used. When used as part of the supermesh system described in the Typical Weak Rock Top-Cut Mining Cycle section, the welded wire mesh reinforcement is installed following an initial shotcrete flash coat. A second layer of shotcrete is then applied to encapsulate the wire mesh reinforcement, followed by the installation of primary bolts with plates through the structure.

When this system is loaded by the rock mass, the forces are distributed into the supermesh matrix through the encapsulated wire mesh. The grid configuration of the mesh helps to redistribute the large reactant point loads that the rock bolts would otherwise introduce to the shotcrete.

Toughness describes the ability of the reinforced shotcrete to sustain and redistribute load after cracking. Toughness is quantified in terms of post-crack, load-carrying capacity or energy absorption, which can be assessed using panel or beam testing specimens. Guidance on toughness values to specify for mining applications can be obtained from various geotechnical design tools. This is covered in more detail in the testing section of AuSS [2008].

Shotcrete Reinforced with Polypropylene or Steel Fiber

As in the use of welded wire mesh described in the Support System section of this document, the addition of short steel or polypropylene fibers to shotcrete can increase toughness (post-crack ductility) that can prolong and preserve the integrity of the structure when subjected to tensile stresses. The selection of welded wire mesh over fiber reinforcement is based on ground conditions and the mine management's determination of the cost-benefit ratio. In the case of weak rock conditions, welded wire mesh is used because ground movement in excess of 25 mm (1 in) is expected and welded wire mesh offers superior performance.

To increase tensile or flexural strength fiber dosage can often be reduced in the unbroken cementitious material [AuSS 2008]. The benefits of fibers compared to the use of steel mesh reinforcement include a significant reduction in cost and effort because the equipment and personnel required for handling and installation of the wire mesh panels are eliminated. Compared with wire mesh panels, fiber-reinforced shotcrete has advantages in terms of ground support and cost when applying a uniform thickness of shotcrete over irregular surfaces. Shotcreting over pre-installed wire mesh panels cannot exactly follow the contour of the rock surface and, as a result, many bridged voids are created that require more material to be applied to bring the shotcrete layer up to the plane of the wire mesh and create the necessary encapsulation. Blinding behind the individual wires of the mesh is also a problem that requires considerable skill to overcome on the part of the applicator. Problems with fiber reinforcement are directly related to the fibers themselves. Several mining operations have relayed that they will not use fiber reinforcement because, in the case of the poly product, it creates serious problems with the mine's water management and removal system because fibers can clog sump pumps. In the case of the steel fibers, a serious safety issue exists because of the potential for mine personnel to become injured from abrasive contact with steel fibers.

Shotcrete Mix Characteristics

Application

The batched and mixed shotcrete must have a consistency that can be transported and applied to the mine surfaces without bleeding (washing out constituent materials or becoming segregated), including sufficient adhesion and cohesion to stick and hold to overhead surfaces and not run down vertical surfaces [AuSS 2008].

Early Strength

Re-entry time is critical to the speed of the mining cycle used in weak rock. The applied shotcrete material must develop enough strength to be self-supporting upon application and develop additional strength that allows mine workers and equipment to re-enter and install in-cycle mining support [AuSS 2008].

Flexural Strength

The applied material must develop the specific load capacity and toughness within the variation allowed by the design criteria and ground control system [AuSS 2008; Bernard 2008].

Typical Formulations for Wet Mix and Dry Mix Shotcrete

A typical shotcrete mix in both wet and dry forms is summarized in Table 3. These mixes can be used as a starting point for reference. It should be noted that most shotcrete mixes are preblended by the shotcrete suppliers who have a set number of mix variations available based on application and cost. These mixes can be purchased as premixed bags having capacities of up to 1,500 kg (3,306 lb). The size of the bag for dry or wet mix applications is limited by the strength of the available bag as per ASTM C136 [2006].

Table 3. Typical mix designs for steel-fiber-reinforced shotcrete with silica fume additive, after Wood [1992]

a. Dry mix

Mix constituent	Amount, kg/m³ (lb/yd³)	Percentage of dry materials, %
Cement	420 (708)	19
Silica fume additive	50 (84)	2.2
Blended aggregate	1,670 (2,815)	75.5
Steel fiber	60 (101)	2.7
Accelerator	13 (22)	0.6
Water	controlled at nozzle	controlled at nozzle
Total	2,213 (3,730)	100

b. Wet mix

Mix constituent	Amount, kg/m³ (lb/yd³)*	Percentage of wet materials, %
Cement	420 (708)	18.1
Silica fume additive	40 (67)	1.7
Blended aggregate	1,600 (2,697)	68.9
Steel fiber	60 (101)	2.6
Accelerator	13 (22)	0.6
Superplasticisor	6 L (6.3 qt)	0.3
Water reducer	2 L (2.1 qt)	0.1
Air entraining admixture	if required	if required
Water	180 (303)	7.7
Total	2,321 (3,912)	100

*Unless listed otherwise as liters and quarts

Shotcrete Application

The shotcrete application process has a major effect as to the final quality of the installed shotcrete material. This process is impacted by onsite conditions and includes surface preparation and application phases. The onsite lighting and visibility available to the mine worker and support crew applying the material must be good enough for the operator to see the application area in detail and to communicate commands effectively.

The size and shape of the mine opening can dictate the application method and type of equipment that can be used. If the mine opening size is too small or too large, mechanized, manipulator-type devices cannot be used and the material will have to be applied manually. The mobile chassis and manipulator arm of the mobile equipment has a fixed size, range-of-spray motion, and various maneuverability characteristics. In some cases, manipulator-type shotcrete application equipment is too large to spray shotcrete and to maneuver effectively [AuSS 2008]. In other cases, the size of the opening can be so large that the shotcrete application process will have to be performed manually from a suitably sized man-lift platform [Pakalnis 2010].

Substrate Preparation

Shotcrete quality is influenced by the condition of the surface onto which it is applied [Barton and Brandis 1990]. The amount of surface preparation required depends on the condition and nature of the substrate against which the shotcrete is to be applied. In weak rock conditions only minimal surface preparation can be completed because of the loose and raveling nature of the host rock [Spearing 2001]. Shotcrete should not be applied directly to dry, dusty rock surfaces, so the work area surface is sprayed top to bottom (from the back to the floor) with water to predampen the surface. This predampening creates a good surface on which to bond the initial layer of shotcrete and prevents loss of water from the newly applied shotcrete.

For rehabilitation work over existing shotcrete sprayed on permanent structures, such as shaft stations and shop facilities, where adhesion to the substrate is required as part of the structural system, high-pressure water and scaling are used for substrate preparation in order to promote adhesion. In this situation, it is very important to insure that the application surfaces are free of loose material, dust and films (such as oils), excessive water, and other contaminants which might interfere with bonding of the shotcrete to the surface [Bernard 2008; Kuchta 2003].

Initial Adhesion

Because shotcrete is applied pneumatically and compacted dynamically, it must develop a sufficient cohesive interlock upon impact with the mine surface to be self-supporting [Rispien 2005]. The sprayed shotcrete material should not generate excessive rebound waste. If either the mix consistency in terms of water content (too runny or too dry) or the application technique of the nozzle operator are not correct, then the sprayed material will not adhere. If the material cannot perform in this manner, then the entire process cannot continue [NCA 2007].

Shotcrete Application Process

The shotcrete application process must be correct for the installed material to perform as designed [Morgan 2008]. The shotcrete nozzle operator and shotcrete support crew should be well trained and thoroughly understand the communication signals used, the shotcrete process, and equipment. The same step-by-step process should be used from batch to batch for consistency. In general, the material is applied from bottom to top using a technique of moving the nozzle in small circles. The shotcrete must be applied to the thickness specified in order to perform as designed. Every effort should be made to avoid applying material on top of rebound. For manual application, the operator is usually positioned about 1 to 1.5 m (3 to 4 ft) back from the substrate. For mechanized application using a manipulator arm, the operator is positioned back from the surface, but with a good vantage point, and controls the application with a remote control device [Melbye 2001; Thomas 2009].

Field Testing Methods for Shotcrete Application

The material properties of shotcrete are most commonly referenced in terms of the measurable characteristics described in this section. NIOSH researchers investigated American Society for Testing and Materials (ASTM) test methods to determine material properties of wet and dry shotcrete. It was found that field-capable testing units were needed to test shotcrete in mine environments to determine shotcrete properties in the wet and hardened states. This is due to the mines being located outside typical laboratory locations, so to obtain reliable results the testing needed to be conducted in situ at the mine.

For the weak rock mass ground support systems, there are a number of performance requirements that the shotcrete must satisfy. The shotcrete is applied in-cycle and is the only element of the ground support system that has a time-dependent variability. The entire mining cycle is dependent on the material curing and the onset of this early strength support characteristic. The time required for the material to have acquired enough strength for workers and machinery to be located under the freshly applied material is the most important performance characteristic to quantify for ground support systems with weak rock mass.

Assurance tests should be reliable, meaningful, timely, simple, and relatively inexpensive. The objective is to ensure that the performance of the shotcrete in-place meets operator design requirements. The main targets examined in any shotcrete testing program should be design compliance for shotcrete strength (early compressive strength, flexural strength, and bond strength) and thickness. Existing methods for determining these characteristics were reviewed and found to be unsatisfactory in terms of the assurance test criteria mentioned above.

Therefore, researchers at NIOSH developed a set of shotcrete material property testing machines that can be used directly at the mine site. Prior to this research, shotcrete testing machines were not available for field testing at mines. As a result, mine personnel could not readily determine if the applied shotcrete met the original shotcrete performance requirements for ground support. These portable test machines measure early strength related to re-entry time; flexural load capacity and toughness; and installed quality, thickness, and bond strength. The NIOSH machines required extensive development and field testing to meet quality assurance test criteria. The tests described in the following sections are used to obtain specific measurable shotcrete characteristics.

From a longer-term ground control standpoint, the flexural load-carrying capability and toughness of the cured shotcrete, the quality of the applied shotcrete, and the competency of the underlying rock are also major performance requirements. All of these performance requirements must be established and monitored, first through pre-installation trials and then as part of an ongoing quality monitoring program. Mine staff must have a means of quantifiably determining the material properties for comparison to performance requirements.

Slump Test

The ASTM C143 [2010] slump test should be used for mix design changes, batch plant changes, mixing truck changes, and personnel changes in the shotcrete process. The typical concrete slump test used in the construction industry on cast concrete is used on shotcrete. The test apparatus base is set on a clean level surface and prewetted before each use (Figure 31 through Figure 33). When conducting the test, shotcrete is poured into the test apparatus cone in three equal height layers. Each layer will be rodded 25 times by the steel rod. After rodding the final layer, the top surface of the shotcrete is struck off. To complete the test, the cone is lifted vertically from the shotcrete. The distance that the shotcrete slumps below the apparatus handle is measured. This is deemed as the “slump” of the shotcrete. With the use of wet additives, mixes may require spread tests rather than slump tests.

When design strength is determined at a given water ratio, a slump test is performed and that slump height is documented. If the field slump height is not comparable, overwatering is occurring. Batched shotcrete mix can have added additives to modify the slump at the point of application. If the shotcrete mix batch is overwatered, producing a large slump, then it can be accelerated (mixed with an additive to accelerate setting) to allow it to adhere to the mine walls and roof. This overwatering and accelerating should be avoided as the shotcrete strength characteristics are changed from the original design. The nozzle operator can make the shotcrete stay in place on the mine opening at high slumps with accelerants, but this reduces strength and compromises the structure [Morgan et al. 1999].

In most cases, the overwatering occurs due to the conflicting interests of the shotcrete crew nozzle operator and those of the mine. The nozzle operator does not want to risk plugging the equipment and thus would prefer a wet mix. The mine owners who are paying for the concrete would not like to see this expensive component washed away or incur additional expense due to the necessity of adding accelerants to give a proper consistency for the sprayed material. As always, a balance between the conflicting interests must be achieved. This can be accomplished through training on how to conduct quality control testing and appropriate corrective actions [Spearing 2001].



Photo by NIOSH

Figure 31. Consistency of wet mix shotcrete being loaded into the hopper of a shotcrete machine.



Photo by NIOSH

Figure 32. Filling a slump cone with wet mix shotcrete prior to conducting a slump test in an underground mine.



Figure 33. Slump test with wet mix shotcrete showing a 292-mm (11.5-in) slump; typical slump is 100 to 200 mm (4 to 8 in).

Compression Test

The primary material property specified for plain cured shotcrete is the compressive strength. Compressive strength is measured as the resistance of the shotcrete specimen to an axially applied crushing force, usually referred to as the unconfined compressive strength (UCS). This measure is an indicator of the quality of the shotcrete. The compressive strength of shotcrete in-place is a critical element that is used for design, and therefore needs to be determined. During the application process the strength of a mix as supplied can be changed due to many variables such as accelerators, rebound, poor application techniques, and overwatering. The drilling of sprayed cores from the in-situ shotcrete is the best method to use in determining the compressive strength. The cores should be tested in accordance with ASTM C1140 using cores secured in accordance with ASTM C1609 [2010], ASTM C39 [2011], and ASTM C1604 [2005]. The testing time at 28 days is normally taken to represent the long-term strength of this material.

Early Strength, Partial-beam Compression Test

Purpose of the Test

The goal of early strength testing is to characterize and define the mine worker and equipment re-entry time for a particular shotcrete mix and thus determine when the mining cycle can safely restart with miners and machinery. Early strength testing of in-stope, as-sprayed shotcrete samples can supply specific material properties for the shotcrete that are then comparable to known specifications. This testing can be conducted as part of pre-installation trials and as part of an ongoing quality monitoring program [AuSS 2008].

The early-age strength is the design strength of shotcrete specified at a time interval earlier than the conventional 28-day cure time. In the mining industry, early-age strength is usually in the range of 1–6 hrs before re-entry by miners and equipment after spraying [Rispin 2005]. The safe re-entry time is the time it takes for the freshly applied shotcrete material to have developed enough strength to resist the normal ground pressure [Iwaki et al. 2001]. Early strength equates

to an as-placed, cured shotcrete strength that allows the material to be drilled and the remaining support system elements to be installed without degradation of the shotcrete or its long-term strength gain characteristics [O'Toole and Pope 2006; Clements 2009; Clements et al. 2004].

Literature and research have shown that obtaining drill cores and cylinders does not provide a reliable testing medium; therefore, the early strength compression beam and beam strength tests are used. Suitable results can be obtained by spraying the molds either by hand, or manipulator arm, for both wet and dry shotcrete mixes. The ASTM C-116 [1990] based tester and variations [Morgan et al. 1999; Clark et al. 2011] are the only early-age strength testing devices that involve direct compressive loading of shotcrete samples.

Mechanical Principle

NIOSH designed a portable partial beam ASTM C116 [1990] test machine for use onsite at all the mines (Figure 34 and Figure 35). The unit and apparatus applies a compressive load at a fixed displacement rate to conduct the partial-beam strength determination test. As illustrated in Figure 36, the test sample is loaded in direct compression by the upper (force) and lower (reactant) platens of the test fixture, and compression strength is determined based on the contact area of the platens.

The device is comprised of a small-footprint, self-contained, servo-controlled, stiff-frame press with advanced load-rate and load-collection capability. The operator is presented with a proper scale and resolution load output display. The machine resolution is 0.45 kg (1 lb) over a 2,268 kg (5,000 lb) operating range. A programmable-logic-controller (PLC) driven machine head applies a load to keep the machine at the proper ASTM test cycle displacement rate of 1.278 mm/min (0.050 in/min) with an auto return after 6.35 mm (0.25 in) of displacement [ASTM C116 (1990)]. The automated load cycle greatly reduces the chance of human error and the time required to conduct a test.

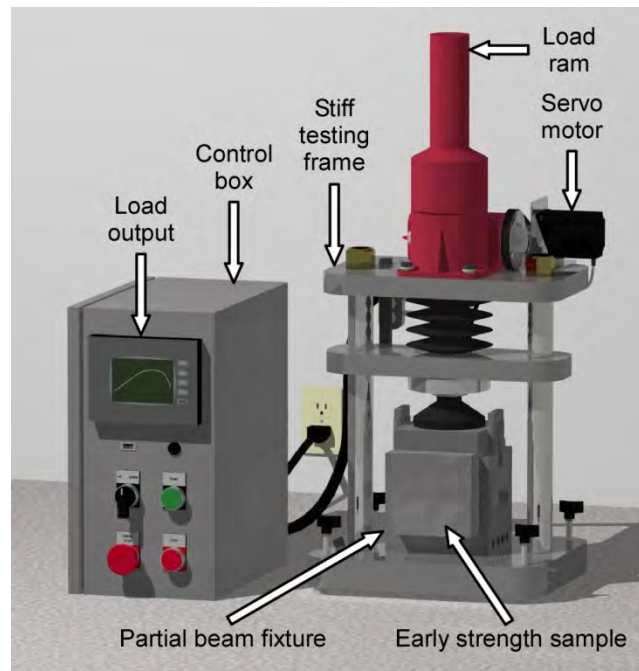

Figure 34. Portable shotcrete test machine designed by NIOSH researchers.



Figure 35. Operation of portable shotcrete test machine.

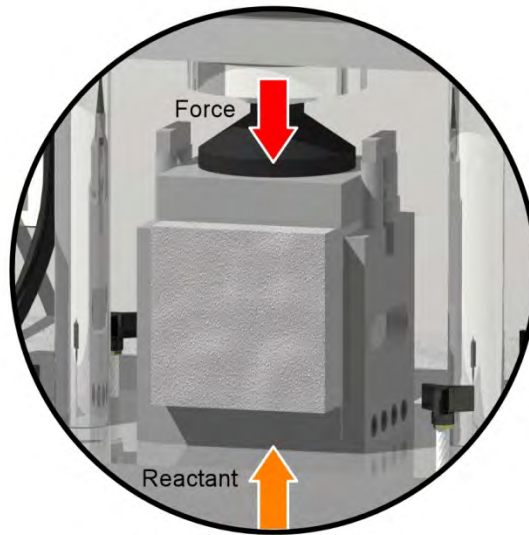

Figure 36. Diagram of the compressive forces applied to a partial-beam shotcrete sample during an early strength test.

Performance Standard

Early strength values were obtained and reported from testing conducted at North American mines for the 1 to 6-hr cure time. These tests produced strength ranges from 1.0 to 1.6 MPa (145 to 233 psi) [O'Toole and Pope 2006], with an early compressive strength equivalent of 1.0 MPa (145 psi) being the norm for safe re-entry time [Rispin et al. 2003; O'Toole and Pope 2006; Bernard 2008]. Typical early strengths and re-entry times worldwide are listed in Table 4. The beam test methods are calibrated against data obtained using this test and the ASTM C1117 [1989] and ASTM C403 [1999] test methods.

Table 4. Typical range of shotcrete early strength and re-entry time by region, after Rispin et al. [2003], O'Toole and Pope [2006], and Bernard [2008]

Region	Early strength, MPa (psi)	Re-entry time, hr
United States	0.5–3 (75–435)	2–6
Canada	1.6–2 (232–300)	2
Austria	0.8–1.6 (116–232)	2–6
Australia	0.5–3 (75–435)	1–6

Test Procedure

The ASTM C116 [1990] testing protocol calls for samples of the shotcrete mixes to be sprayed into 102 x 102 x 152 mm (4 x 4 x 6 in) mold boxes as seen in Figure 37 to make the three test specimens for each hour test. Beam molds have been used successfully for creating test specimens in both the United States and Canada [Heere et al. 2002].



Figure 37. Partial-beam shotcrete mold (left) and shotcrete test sample (right).

A mold containment system, consisting of two frames, was developed by the NIOSH researchers to restrain the partial-beam molds and orient them at a 45° angle to reduce the amount of rebound that would build up in the boxes. The smaller frame houses three partial-beam molds and can be hand-carried to the testing location to conduct 1-hr tests (Figure 38, upper left). The larger frame contains forklift pockets allowing the entire unit to be moved to the test location (Figure 38). This system allows the 2- through 6-hr samples to have the cure time necessary for movement while still allowing for the 1-hr tests.



Figure 38. Containment fixtures and molds for making partial-beam shotcrete samples (large, center; small, upper left).

After the samples have been sprayed, tests are conducted at one-hr intervals over the next six hrs (1 to 6-hr tests). The shotcrete samples are carefully demolded by disassembling the mold fixtures and removing the enclosed samples. Next, a shotcrete sample is placed in a specialized testing fixture and centered under the loading head of the test machine. The loading head is then lowered to a position just above the testing fixture's upper plate via a manual toggle switch (Figure 39). A demolded, sprayed test sample is subjected to a direct compression load between the platens of the test device that induces a complex diagonal tensile failure; the compressive strength is determined based on the contact area of the platens. This testing is conducted on the hour for the time period corresponding to the 1–6 hrs from the time the samples are collected. A minimum of three samples should be tested for each hour interval to determine this strength [ASTM C116 (1990)].



Figure 39. Loading of a partial-beam shotcrete sample during an early strength test.

To conduct a test, the green start switch is depressed initiating the automated test cycle. The PLC-controlled press applies a fixed-rate load to the sample. The load profile is shown on a graphical output display, and the measured test parameters (time, displacement, and load) are stored on a thumb drive. The sample is tested to failure as indicated by the appearance of a crack (Figure 40). The operator will observe a well-defined peak in the load profile curve indicating the test is completed. The test is then stopped by depressing the red button on the test machine's

control panel, and the test machine's loading platen is returned to its initial starting position. After testing only a few samples, it is relatively easy to determine when a test has reached completion. This process is repeated for three specimens so that an average can be determined.

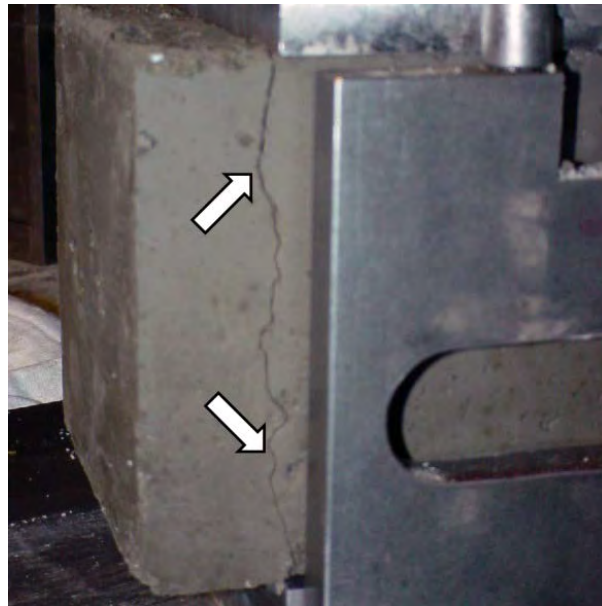

Photo by NIOSH

Figure 40. Shotcrete sample showing vertical shear failure.

Observations

Peak load is reflected by the development of large vertically oriented single or dual side cracks (Figure 41, Figure 42, and Figure 43) along the platen-to-sample contact edges.

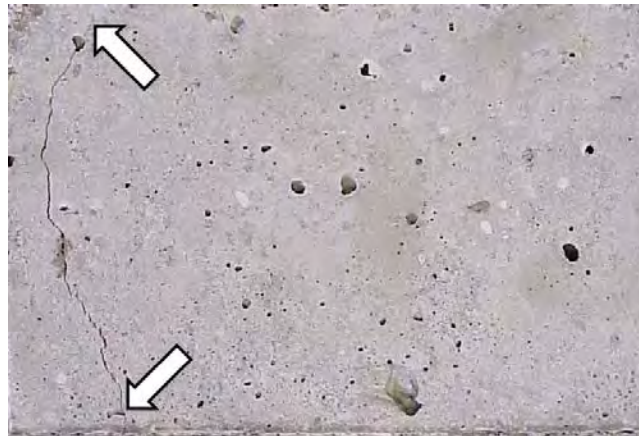

Photo by NIOSH

Figure 41. Shotcrete sample showing single side failure, loaded from top and bottom of specimen.

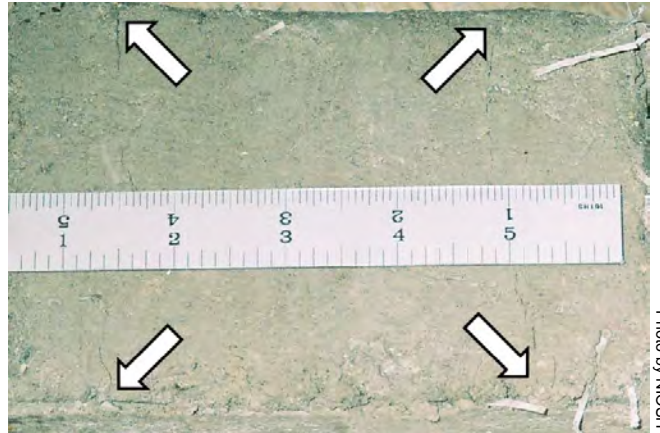

Figure 42. Shotcrete sample showing dual side failure, loaded from top and bottom of specimen.

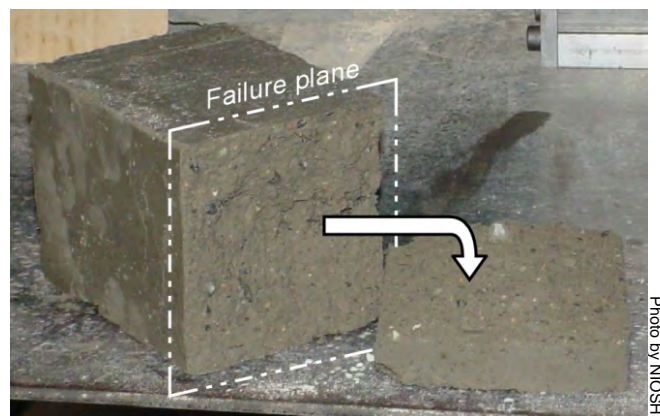

Figure 43. Shotcrete sample showing exposed failure plane.

The vertical crack is a complex failure that exhibits elements of shear, tensile, and compressive failure modes. Figure 44 depicts examples of shotcrete failure modes.

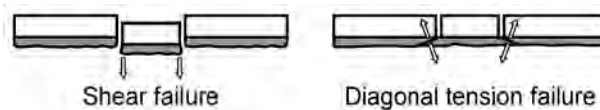

Figure 44. Shotcrete failure modes, after Rose [1985].

Laboratory Tests

Early strength testing of several mixtures of shotcrete was conducted at NIOSH's Spokane Research Laboratory in accordance with ASTM C116 [1990]. The shotcrete was applied to the molds by a competent nozzle operator. The superstick corrosive accelerant (SCA) mixes were supplied by a shotcrete manufacturer, different from the supplier of the K1 and P2 mixes. SCA is manufactured in Nevada and used in Nevada and Montana mines. K1 and P2 are manufactured in the state of Washington and used in Alaska and Idaho mines. The superstick corrosive accelerant polyfiber (SCAPF) and superstick corrosive accelerant steel fiber type-100 (SCAPT-100) are fibered versions of the SCA mix. SCAPF is a polyfibered mix, and SCAPT-100 is a steel-fibered mix. K1 has a greater percentage of accelerants than P2, and P2 has a greater percentage than SCA.

The merits of the shotcrete process in terms of strength gain arising from pneumatic application and dynamic compaction are illustrated in Figure 45. The sprayed material exhibited an order of magnitude strength increase for identically batched samples (five samples each) that were cast from the same mix. The similarity between cast concrete and cast shotcrete in terms of curing behavior with respect to strength gain is also shown in Figure 45. This graph illustrates that the strength gain arises from the application process and not from some mix formulation difference specific to shotcrete. The curing phase of the sprayed shotcrete also shows an accelerated strength gain, followed by a slow down or hump, which is typical for sprayed shotcrete.

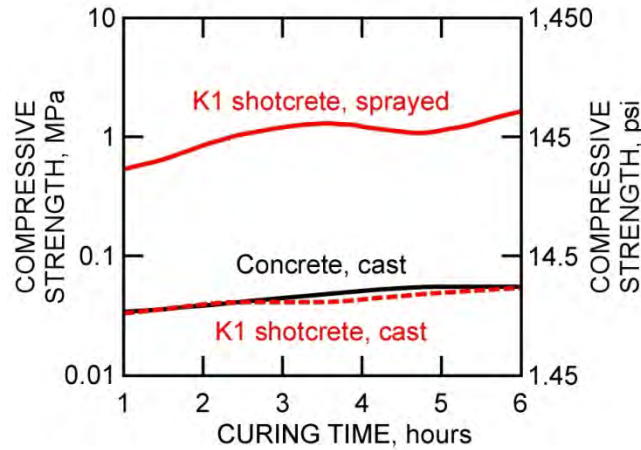

Figure 45. Early-age compressive strength versus curing time for sprayed and cast samples of K1 shotcrete for 1 to 6 hours of curing time.

Figure 46 shows the early-age compressive strength test results for the five commercially available dry shotcrete mixes tested ($n = 72$ samples). The shotcrete strength gain is shown over the time interval from 1 to 6 hrs with four of the five mixes indicating a strength plateau at the 4-hr mark and one mix indicating a strength plateau starting at the 2-hr mark.

This initial set and then phase transfer was observed in all shotcrete samples tested in the NIOSH study. This characteristic has been well referenced in the literature on shotcrete [Jolin et al. 1999; Heere et al. 2002; Knight et al. 2006; Rispin 2005; O’Toole and Pope 2006; Bernard 2008] and is depicted as well in Figure 46. The initial strength gain provided by the accelerant additives appears to progress into a cementitious hydration phase. For the mixes tested, three out of the five reached the early re-entry strength threshold of 1 MPa (145 psi) within 3 hrs and were confirmed again at the 4-hr mark. All of the shotcrete mixes exceeded 1 MPa (145 psi) after 24 hrs of curing.

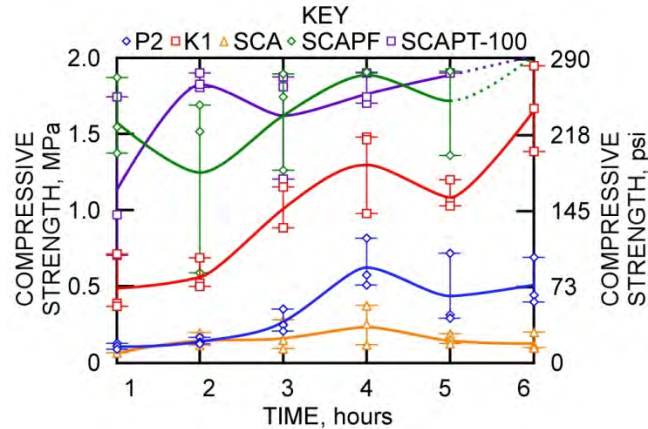

Figure 46. Early-age compressive strength versus curing time for sprayed partial-beam samples of 5 shotcrete mixes for 1 to 6 hours of curing time.

The strength curves shown in Figure 46 are in good agreement with O’Toole and Pope [2006] who reported similar strengths ranging from 0.25 to 2.25 MPa (36 to 326 psi) for tests conducted on partial-beam shotcrete samples after 1 to 6 hours of curing. These strength curves are also similar to Bernard [2008] who reported strength values ranging from 0.2 to 3 MPa (29 to 435 psi) for 1-hr through 10-hr tests on partial-beam samples of shotcrete.

After six hrs of curing, the fibered mixes exceeded the capacity of the test machine (shown as dotted lines in Figure 46), with compressive strengths greater than 2 MPa (290 psi). For this test method, the addition of fibers generally produced higher early strengths.

Field Verification of Test Method and Apparatus for Determining the Early Strength of Partial-beam Shotcrete Samples.

Purpose of the Test

The early strength test machine is used to identify the onset of 1-MPa (145-psi) strength gain of the shotcrete from 1 to 6 hrs. The field trials consisted of collecting multiple shotcrete samples from the mine and testing the early strength gain of the shotcrete.

Trial Infrastructure

The Turquoise Ridge Joint Venture (TRJV) near Goldconda, Nevada supplied the shotcrete product, SCA (Figure 31). The mix consistency as measured by a slump test was 29.2 cm (11.5 in) (Figure 32 and Figure 33). Samples were collected in-stope on the 3,550 level of the mine and tested in the mine’s material property testing lab on the 1,250 level of the mine.

Sample Collection

A mechanical shotcrete machine was used to spray eighteen early strength shotcrete test samples. The wet-mix shotcrete was applied using a remotely controlled arm with an oscillating nozzle that allowed for a uniform deposition of the material into the sample collection boxes measuring 102 x 102 x 152 mm (4 x 4 x 6 in) from a distance of about 1.2 m (4 ft) (Figure 47). This method of collecting shotcrete test material ensures an accurate sampling of the actual mine mix from which a true early strength time can be developed.



Figure 47. Positioning partial-beam shotcrete molds and containment fixtures prior to shotcreting.

After the samples were sprayed, they were immediately hand-troweled for a uniform top surface. The 1-hour test samples were carefully transported by researchers riding in the tractor from the spray location to the test site. The remaining 15 samples were allowed to cure longer before being transported on foam in a tractor basket to the test site.

Testing

Early strength tests were conducted with partial-beam shotcrete samples using the NIOSH portable test machine in accordance with ASTM C116 [1990]. Figure 48 and Figure 49 show a partial-beam shotcrete sample being tested at the field site.

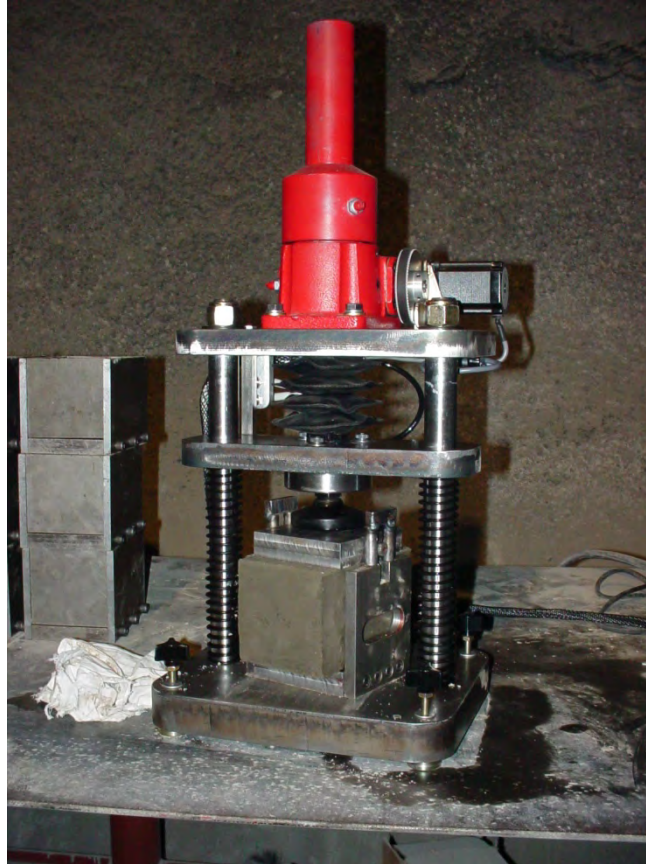

Photo by NIOSH

Figure 48. Portable test machine for determining early-age strength of shotcrete.

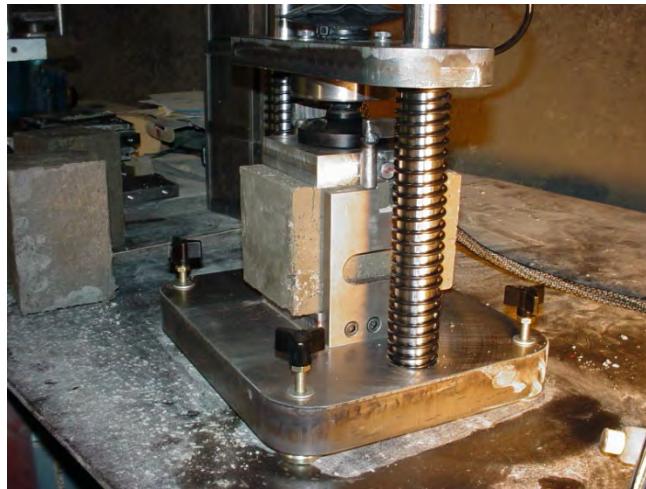

Photo by NIOSH

Figure 49. Loading of partial-beam shotcrete sample during an early strength test.



Figure 50. Shotcrete sample showing exposed failure plane.

Trial Results

The peak strength values for the six hourly tests are listed in Table 5. For a wet mix shotcrete with a 292.1-mm (11.5-in) slump, the re-entry time was determined to be 5 hrs at an average early strength of 1.18 MPa (171.6 psi). As mentioned by Melbye [2001], an earlier re-entry time may be achieved by using a shotcrete mix with a lower slump.

Table 5. Early strength test results for partial-beam shotcrete samples using the NIOSH portable test machine

Curing time, hr	Sample 1 Ultimate stress, MPa (psi)	Sample 2 Ultimate stress, MPa (psi)	Sample 3 Ultimate stress, MPa (psi)	Average Ultimate stress, MPa (psi)
1	0.07 (9.9)	0.15 (21.1)	0.13 (18.4)	0.12 (19.8)
2	0.21 (30.0)	0.19 (27.6)	0.19 (27.7)	0.2 (28.5)
3	0.33 (48.2)	0.41 (58.7)	0.41 (59.2)	0.38 (55.1)
4	0.53 (76.5)	0.57 (82.4)	0.68 (98.8)	0.59 (86.0)
5	1.24 (179.5)	1.19 (173.3)	1.12 (162.8)	1.18 (171.6)
6	1.69 (245.1)	1.50 (218.0)	nr*	1.60 (231.9)

*nr = not reported

Figure 51 shows the early-age compressive strength versus curing time for partial-beam shotcrete samples tested at the mine site. Of particular note is the shallow slope of the strength curve up to 4 hrs, followed by an accelerated strength gain as the mix cured further in the 4 to 6-hr period. As noted by Clark et al. [2011], a similar strength gain or change in the slope of the early strength curve has been observed during other tests conducted at the OMSHR facility in Spokane. Furthermore, this strength gain trend is comparable to the results of other early strength tests reported by the mining industry [Clark et al. 2011]. However, test results can vary, and they are highly dependent on the characteristics of the specific shotcrete mix and also on the sampling and testing procedures. For example, the results of these early strength field tests showed a much

more uniform and consistent trend in strength gain than laboratory tests conducted with a similar K1 shotcrete mix (Figure 46). As a result, shotcrete early strength tests should be conducted routinely at the mine site to verify safe re-entry times.

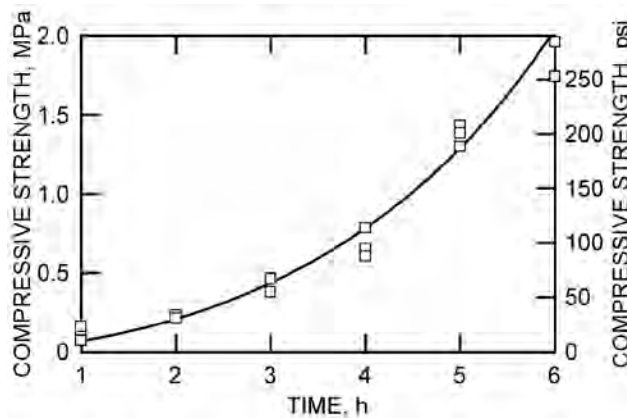

Figure 51. Early-age compressive strength versus curing time for partial-beam samples of K1 shotcrete with 1 to 6 hours of curing time.

Overcoring and Direct-Tension Pull Test

Purpose of the Test

The goal of the overcoring and direct-tension pull testing is to characterize and define the quality and bond strength of the applied shotcrete and thus, determine if the application protocol has been followed and what, if any, load-carrying support is provided by the shotcrete to rock bond. This inspection and testing is conducted in-stope at the shotcrete application site as part of an ongoing quality monitoring program.

The installed quality is assessed by comparing the observable core characteristics to known standards set forth in the quality monitoring program. Upon retrieving the core samples, host rock quality and strength can be compared to that of the shotcrete and an assessment made as to whether the rock is physically stronger or weaker than the shotcrete based on where the break occurred. The core cross section can be visually examined to reveal the structure of the shotcrete application with regard to defects and the presence of structural reinforcement in the form of welded wire mesh or fiber.

Bond strength, the adhesion of the shotcrete to the host rock, provides additional load-carrying support over and above the ground support supplied by the system's conventional support components—primary and secondary bolts with plates. Bond strength is reported in terms of peak tensile load values for the shotcrete to underlying rock bond using direct tensile pull test methods. Core inspection and direct tensile testing can supply specific information regarding the quality of the applied shotcrete, the competency of the underlying rock, and the bond strength of the shotcrete to the rock [Hahn and Holmgren 1979]. Bond strength is a very difficult property to measure. The measurement of bond strength is accomplished using a drilled shotcrete core pulling apparatus. Although there are nondestructive tests like hammer sounding and chain dragging, these do not determine the strength but only detect voids through sound differences. To determine if the shotcrete has bonded correctly to the host rock or underlying shotcrete layer, a pull test is required.

Several methods, however, have been put forth for use, including the ASTM C1583/C1583M [2004], and internationally, the European Federation of National Associations Representing Concrete (EFNARC) bond test and the Swedish Standard test [AuSS 2008]. Most existing test methods that attempt to establish an actual bond strength value involve proprietary equipment for the extraction of a core from in-place shotcrete. These test methods are difficult to perform, cumbersome, and unreliable, and the required equipment is generally unavailable.

For this reason, NIOSH researchers developed a bond strength testing method and equipment [Seymour et al. 2011]. This system provides a practical method of determining bond strength through a direct tensile test conducted in underground mines. This measurement of shotcrete bond strength can be accomplished in as soon as one day following application [Malmgren et al. 2005]. This helps confirm when the shotcrete strength (bond) is sufficient to support its own weight. It is important to measure shotcrete bond strength on test sections during the initial phase of curing in order to help identify when it is safe to work under the recently sprayed shotcrete.

Mechanical Principle

To determine shotcrete bond strength, NIOSH researchers designed a portable test system for determining shotcrete bond strength in underground mines [Seymour et al. 2011]. Through this test system, the bond strength can be determined by conducting a pull test on the applied shotcrete. The system enables in-place (in situ) coring of the cured shotcrete matrix followed by controlled direct-tensile loading of the cored sample to failure. The basic test configuration consists of a core-shaped sample produced through diamond drilling, and then through the use of an installed stud pull anchor, a direct tensile force can be applied with a loading ram on the core to induce a tensile failure. The failures occur in the shotcrete matrix, and also in the shotcrete-to-shotcrete and shotcrete-to-rock interfaces.

This method of determining bond strength involves the generation of three concentric core holes from a single drill setup. A 102-mm (4-in) diameter core is then extracted in direct tension through the use of an epoxied pull-stud and an extraction device that ensures concentric loading. Bond strength is given in terms of the stress required to fail the core specimen in tension. The system primarily consists of a small, stand-mounted core drill, and a pulling-unit equipped with a precision digital pressure gauge (Figure 52 and Figure 53). As illustrated in Figure 54, the cored test sample is loaded in direct tension by the pulling cylinder (force) and base fixture ring (reactants). Bond strength is determined based on the cross-sectional area of the test sample. The pulling unit load is produced by manually pumping a hydraulic power pack connected to a hollow ram cylinder that is capable of exerting 5,443.1 kg (12,000 lb). The cylinder applies a direct axial load to the cored sample via an embedded pulling stud. The loading rate is controlled by the cycle rate of the hand pump. The load rate is adjusted by the operator to coincide with a test duration of approximately 1 to 2 min. A dial pressure gauge is used with a scale and resolution of 0.007 MPa (1 psi) over a 0 to 60-MPa (0 to 8,700-psi) operating range.

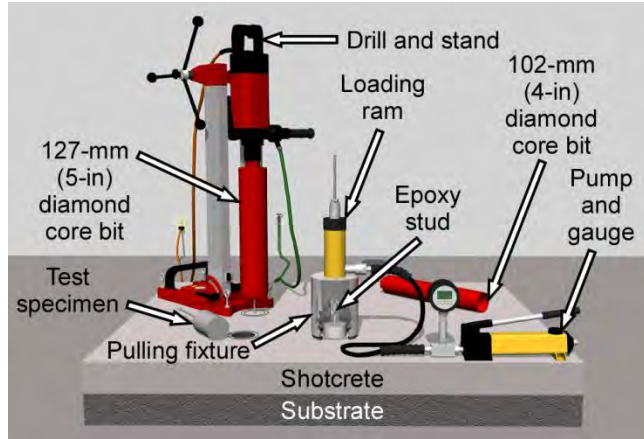

Figure 52. Schematic of overcoring and direct-tension test equipment for determining shotcrete adhesion strength.



Figure 53. Operation of overcoring and direct-tension test equipment.

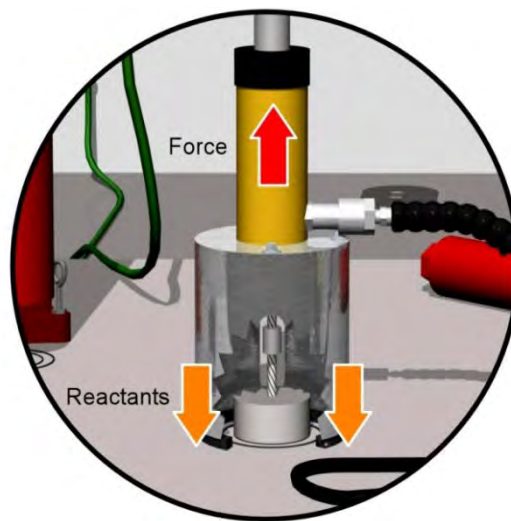

Figure 54. Tensile loading of shotcrete core sample to determine bond strength.

Performance Standard

Typical indicators of application quality with regard to the cored sample include: the applied thickness, the presence of voids or lenses of noncompacted material, the presence of reinforcement (type, location, and density), the quality or tensile strength of the underlying host rock, the bond strength of the shotcrete to the host rock substrate or an underlying layer of shotcrete, and the relative location of the failure surface on the test core (Table 6). During the pull test, the core sample fails in tension. This tensile failure can occur in the shotcrete, at the bond surface (the interface between the shotcrete and an underlying layer of shotcrete or the interface between the shotcrete and the rock), in the rock, or at some combination of these locations. Typical values for the bond strength of shotcrete applied to different substrates are listed in Table 7.

Table 6. Typical indicators of the quality of a shotcrete application obtained through a careful examination of the test core and drill hole

Parameter	Typical value
Matrix thickness	38–51 mm (1.5–2 in)
Presence of voids (air to solids ratio)	yes (%), no
Presence of lensing (air to solids ratio)	yes (%), no
Presence of reinforcement	yes (#), no
Type of reinforcement	Wire mesh, steel fiber, synthetic fiber
Density of reinforcement	Sparse, average, extreme
Host rock quality	RMR* or Q [†]
Bond to underlying host rock	0.2–1.5 MPa (29–218 psi)
Failure surface location	In shotcrete (%), at interface (%), in host rock (%)

*RMR = Rock Mass Rating

[†]Q = Rock Mass Quality

Table 7. Typical range for shotcrete bond strength with differing substrates*

Interface	United States, MPa (psi)	Other Countries,[†] MPa (psi)	Sweden, MPa (psi)
Shotcrete to shotcrete	nr [‡]	nr	1.0 (145)
Shotcrete to rock	nr	0.2–1.5(29–218)	0.5 (73)
Shotcrete to concrete	0.69–1(100–145)	0.5–3 (73–435)	1.5 (218)

*after Brennan [2005]; Nordström and Grändås [2005]; Barrett and McCreath [1995]; Malmgren and Svensson [1999]; Kuchta [2003]; Malmgren et al. [2005]; Saiang et al. [2005]; Morton et al. [2008]

[†]Austria, Australia, Canada

[‡]nr = not reported

Test Procedure

The shotcrete bond strength test starts with the selection of a test site. Because this is an in-situ test, the location of the test site can be either predetermined or random. Sites could be randomly selected for quality control purposes, whereas specific areas of shotcrete fallout could be preselected to verify that shotcrete rehabilitation measures had corrected application problems. At least three tests should be performed at each general location to develop a statistical set of bond strength values. Once the desired location for a test has been determined, a hand-operated rotary percussive drill is used to drill a 16-mm x 51-mm (0.625-in x 2-in) hole for anchoring the drill stand. The hole is cleared of debris, and a threaded expansion anchor is installed, followed by a 13-mm-diameter (0.5-in-diameter) stud onto which the drill stand and core drill are mounted in position (Figure 55). Next, an 11.1-mm-diameter (0.4375-in-diameter) hole is drilled dry into the shotcrete, using a rotary percussive bit, to a depth of about 60 mm (2.375 in), assuming a shotcrete thickness of 75 mm (3 in). The hole is cleaned, filled with a quick-setting, two-part epoxy adhesive, and a 9.5-mm (0.375-in) diameter pull anchor is inserted. After the epoxy has initially set or gelled (approximately 15 min), a 102-mm-diameter (4-in-diameter) diamond core bit is used to wet-drill a second hole through the shotcrete to a depth of about 25 to 50 mm (1 to 2 in) into the underlying rock. Finally, a 127-mm-diameter (5-in-diameter) diamond core bit is used to wet-drill a shallow kerf for seating the base of the pulling fixture (Figure 56).



Photo by NIOSH

Figure 55. Wet drilling with diamond core bit.

Figure 56 shows the test site after the pull anchor has been epoxied into place, the hole for the test core has been drilled into the underlying rock, and a kerf has been drilled for the base of the pulling fixture. Figure 57 shows a vertical cross-section schematic of the drill hole configuration for the pull anchor, shotcrete test core, and pulling fixture kerf. Using these procedures, three parallel, concentric drill holes are produced. This drill hole configuration reduces eccentric loading during the direct-tension pull test and ensures that a uniform tensile load is applied to the shotcrete test core.



Photo by NIOSH

Figure 56. Drill hole configuration with extension rod connected to epoxied stud.

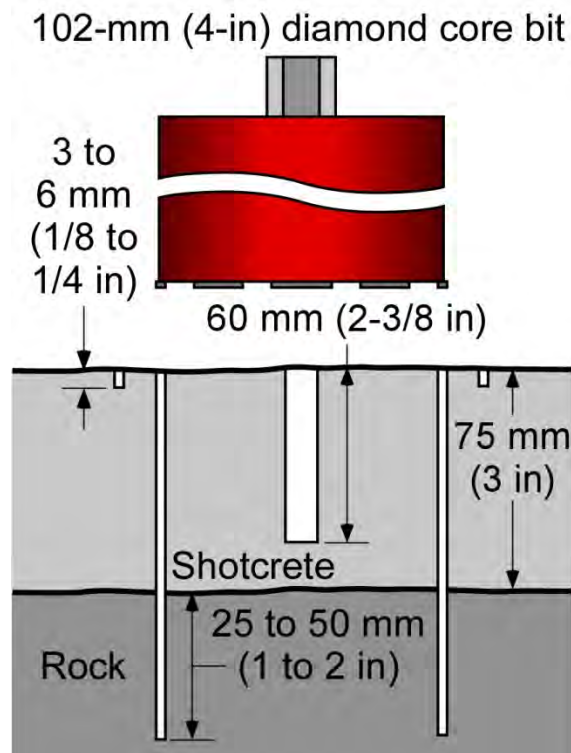

Figure 57. Schematic showing a vertical cross-section of the drill hole configuration for a shotcrete bond strength test.

After the the core drilling is completed, the drill stand is removed, and a hand-operated rotary percussive drill is again used to drill two additional 16-mm x 51-mm (0.625-in x 2-in) holes. These holes are located about 508 mm (20 in) from the epoxied stud and spaced on a 120° pattern with the first hole that was original used for mounting the drill stand (Figure 58). Next, the holes are cleared of debris, and threaded expansion anchors are installed. Three aluminum strap brackets that will be used to anchor the pulling fixture are then bolted to the shotcreted surface of the underground entry using 13-mm-diameter (0.5-in-diameter) fasteners (Figure 58).



Figure 58. Strap brackets centered around the epoxied stud to anchor the direct-tension test equipment.

After the epoxy has fully set (30–60 min), a threaded extension rod is connected to the pull anchor with a coupling nut, and the pulling fixture is carefully placed over the core sample with the base of its reaction ring positioned in the kerf of the outer drill hole. Safety straps are then installed through the eyelets on the strap brackets bolted to the housing of the pulling fixture and the strap brackets mounted on the surface of the mine entry. The safety straps are tensioned to secure the pulling fixture in position. The hydraulic hose from the hand pump is then connected to the hydraulic cylinder, and the pump and cylinder are cycled several times to purge extraneous air from the hydraulic system. Next, a collet and a slip-on, quick-threading locknut are connected to the threaded extension rod to serve as a mechanical stop for the pulling fixture’s ram (Figure 59). Prior to conducting the test, the pressure gauge should be zeroed by pressing the reset button. To conduct a direct-tension test, an increasing tensile load is applied to the core sample through a slow and steady movement of the pump handle until the core breaks. Test duration varies depending on the tensile strength of the test core (typically 30 sec to 2 min). After testing only a few samples, it is relatively easy to determine the required pumping rate. This test process is repeated with as many core samples as needed until the shotcrete bond strength is characterized for the selected test area. An explanation of the procedures and calculations that are used to determine the tensile strength of the test core from the maximum hydraulic pressure obtained from the pressure gauge are provided in the Appendix.



Photo by NIOSH

Figure 59. Pulling unit mounted to mine rib using a three-point safety restraint.

Laboratory Testing and Results

Six test panels with nine core test locations were sprayed at the Spokane Research Laboratory to provide for tester commissioning and to develop a series of data points for comparison to field results. The cores were tested from 4 hrs to 90 days of cure time, and a total of 54 samples were tested.

Results from spray panel tests conducted at the Spokane facility indicate that the shotcrete average adhesion strength increased markedly from 1 to 3 days of curing, from 0.44 to 1.13 MPa (64 to 164 psi) or, in other words, from 28% to 72% of the average 90-day adhesion strength (Figure 60).

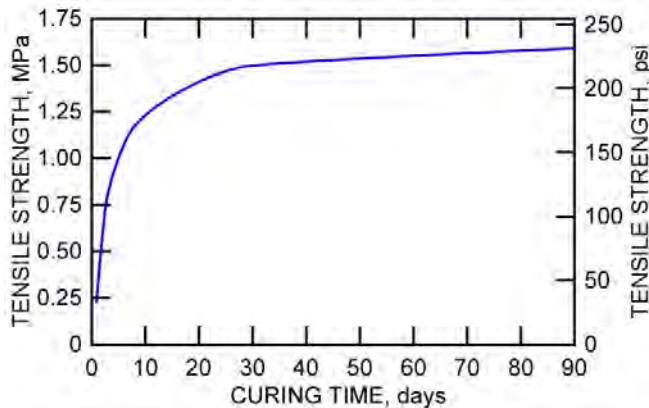

Figure 60. Typical shotcrete tensile strength test results for 0–90 day cure time (n=54).

The average bond strength test values increased with shotcrete curing age and ranged from 0.44 MPa (64 psi) after one day of curing to 1.58 MPa (229 psi) after 90 days of curing. The range of these results are comparable to previously published values for the adhesion of shotcrete to concrete test panels [Malmgren and Svensson 1999; Kuchta 2002] and are within the normal range of bond strengths specified for shotcrete applied to concrete substrates [Brennan 2005; Nordström and Grändås 2005].

Observations During the Coring and Tensile Test

As wet core drilling is conducted, a series of operational conditions should be monitored continuously throughout the process. These include, but are not limited to, the return water from the drill, color of the cuttings coming out with the drill water, torque reaction through the drill stand, drill pressure necessary for penetration, and core breakage (Figure 55). With regard to these conditions, normal operation would consist of a continuous flow of drill water with a component of shotcrete cuttings followed by cuttings containing the host rock. The drill torque through the drill stand can also provide an indication of the quality of the shotcrete. In competent shotcrete, the drill will have a constant harmonic vibration and sound and will rotate and drill smoothly. Furthermore, the drill pressure required for penetration, as indicated through the stand handle, will be constant and steady if no voids or loose shotcrete lenses are present in the shotcrete. The driller can feel and see core breakage due to lensing. The drill bit will advance rapidly and no cuttings will be present in the drill return water. Another indicator is that the drill speed can increase and then stall as it enters and then exits a void.

An indication of a proper pull test is that a consistent pressure increase on the gauge develops with each pump stroke. The core sample breaks in an abrupt manner when the ultimate tensile load has been reached. Testing of core samples that have lensing, low adhesion, and voids produces no buildup on the pressure gauge and little or no resistance on the pump handle. Another core failure that provides small load is the case of fiber lensing, where there is high deflection but little gauge pressure or resistance on the pump handle as the core sample pulls apart.

To aid in the interpretation of the bond strength test results, the failure surface on the test core should be examined along with the bottom of the drill hole. The failure location should be recorded as a percentage of the shotcrete, interface, and substrate that are exposed on the tensile failure surface (Figure 61). In addition, the overall depth of the 102-mm-diameter (4-in-diameter) drill hole should be noted along with the length of the test core and the thickness of the shotcrete layer so that drilling depth for the pull anchor and test core can be adjusted if necessary.

Following the direct tensile test, the broken core is inspected and the key elements of quality are noted [Neville 2009]. Any lenses or voids or their absence in the core can be observed. Also, the presence and location of any reinforcement in the core profile can be determined from the extracted core. Furthermore, the thickness of the shotcrete application can be measured, and the shotcrete-to-shotcrete application profile can be evaluated. Finally, the host-rock-to-shotcrete interface and the structure of the host rock can be observed and noted (Figure 61).



Figure 61. Shotcrete test core and drill hole from a bond strength test with dry mix shotcrete applied to a concrete substrate.

Field Verification of Test Method and Apparatus for Determining the Bond Strength of Applied Shotcrete

Purpose of the Test

The overcoring and direct-tension pull test equipment are used to determine the bond strength and quality of applied shotcrete. Field trials were conducted with this portable test system in an underground mine to verify test procedures, confirm that the test equipment was suitable for use in underground mining conditions, and evaluate the system's ease of use by mine personnel.

Testing Location

The Turquoise Ridge Joint Venture (TRJV) near Goldconda, Nevada provided a test site along a shotcreted rib of an underground entry on the 1,250 level of the mine. A wet mix shotcrete had been previously sprayed on the mine rib in two applications at a design thickness of 75 to 100 mm (3 to 4 in).

Test Procedure

As shown in Figure 62, three test sites were selected on fairly even surfaces of the shotcreted rib about 1.2 to 1.5 m (4 to 5 ft) above the mine floor. Each drill stand was secured to the mine rib using the procedures described previously in the Overcoring and Direct-Tension Pull Test section of this document.



Figure 62. Shotcrete adhesion test site with three drill stands mounted on mine rib.

Once the drill stand was mounted to the mine rib, the testing protocol was followed as described in the previous Test Procedure section and as shown in Figure 63 through Figure 65.



Figure 63. Dry drilling the installation hole for the epoxied stud pull anchor.



Figure 64. Wet drilling a 102-mm (4-in) diameter hole for the shotcrete adhesion test core (note bit change).



Photo by NIOSH

Figure 65. Preparing to remove drill stand and install direct-tension test equipment.

Trial Results

The results of the three shotcrete bond strength tests conducted at the mine are shown in Table 8. The tensile strength of the shotcrete test cores varied from 1.3 to 1.7 MPa (189 to 246 psi) and are within the typical range of shotcrete bond strengths reported by other researchers (Table 7). The location of the tensile failure surface on the test core varied depending on the test as noted in Table 8. The shotcrete test cores failed in the shotcrete, at a shotcrete-to-shotcrete interface, at the shotcrete-to-host-rock interface, and in the host rock. The relative location of these tensile failures is given as a percentage of the total area exposed along the failure surface.

Table 8. Shotcrete adhesion test results

Test number	Maximum tensile strength, MPa (psi)	Failure surface location, (%)
1	1.7 (246)	Shotcrete (70), interface (30)
2	1.3 (189)	Shotcrete (100)
3	Core broke prematurely in rock	Rock (95), interface (5)

Photographs of the drill holes and test cores after the shotcrete bond strength tests were conducted are shown in Figure 66 through Figure 71. A visual examination of the test cores indicated that at least two layers of shotcrete were applied in the test area. As shown by the photographs in Figure 70 and Figure 71, the measured overall thickness of the shotcrete layers varied from 114 to 127 mm (4.5 to 5 in) over the 5-m (15-ft) lateral spacing of the three test sites. Furthermore, there was no indication that fiber or wire mesh were used at this location to reinforce the shotcrete. For the first two tests, the cores broke primarily in the shotcrete. The core from the first test broke at or near the interface between two shotcrete layers. In the second test, the core broke in the top shotcrete layer at a bond strength exceeding 1.0 MPa (145 psi), the typical required bond strength for shotcrete applied to shotcrete as noted in Table 7. The third test core broke prematurely at the beginning of the test, more than likely due to the weak underlying host rock (Figure 68 and Figure 69). Although a limited number of shotcrete bond strength tests were conducted at this field site, these tests confirm that the test cores will normally break in the shotcrete matrix unless the underlying rock is exceptionally weak or highly fractured.



Figure 66. Adhesion test #1: core broke in shotcrete and at interface between two shotcrete layers.



Figure 67. Adhesion test #2: core broke entirely in the top layer of shotcrete.



Figure 68. Adhesion test #3: core broke prematurely in weak underlying host rock.



Figure 69. Adhesion test #3: drill hole and core indicating a tensile failure located primarily in the host rock.



Figure 70. Test core #3: tensile failure in weak host rock.



Figure 71. Adhesion test cores showing two breaks in shotcrete (left, test 1 and middle, test 2), and one break in host rock (right, test 3).

Round Determinate Panel Flexural Test

Purpose of the Test

The goal of round determinate panel testing (RDPT) is to characterize and define the peak flexural load, the post-crack load-carrying capacity at a given displacement, and the toughness of a particular shotcrete mix and thus determine if the material can withstand the anticipated mine opening support loadings. Peak load capacity represents the maximum load the material can withstand prior to cracking. Residual load capacity is reported in terms of resistive load at subsequent increasing deflections. Toughness is derived from the aggregate area under the load capacity versus displacement curve and is indicative of the energy required to displace the specimen through a given distance. Both flexural load capacity and toughness represent the ability of shotcrete reinforced with welded wire or fiber to carry load following cracking, and therefore continue to offer structural support. Flexural load capacity and toughness testing can supply specific material properties for the shotcrete that are then comparable to known specifications. This testing can be conducted as part of pre-installation trials and as part of an ongoing quality monitoring program.

Flexural load capacity is the peak or breaking load when the shotcrete is subjected to bending forces and the force on the shotcrete specimen post-peak is usually up to 40 mm (1.6 in) of deflection. The flexural capacity is given in terms of the load at failure or at a given post-peak displacement for the specimen. The flexural load capacity can serve as an indirect indication of the strength of a member when subjected to bending. The residual flexural load capacity is determined as a post-crack load resistance at a specified deflection.

Toughness is a measure of the amount of energy that the shotcrete can absorb for a given displacement and still retain some load capacity. It is an important property where post-crack displacement and deformation are expected. Toughness and absorbed energy can be assessed from load and displacement that are measured while conducting a round determinate panel test. The total absorbed energy is affected primarily by adding reinforcement (welded wire mesh or fiber). In the case of welded wire mesh, the wire spacing and gauge which correlates to the wire cross-sectional area will affect the toughness. In the case of fiber, the toughness changes by the type and density of fibers. Toughness can also be strongly influenced by the strength and quality of the shotcrete matrix [Papworth 2002].

The flexural load capacity and toughness of shotcrete that is encapsulated with welded wire mesh or fiber-reinforced shotcrete can be determined using an adaptation of the ASTM C-1550 [2010] test employing sprayed 75-mm-thick x 800-mm-diameter (3-in-thick x 31.5-in-diameter) round panel samples.

As determined by the ASTM C1550 standard [2010], the test panel that sits on three pivots symmetrically arranged around its circumference is subjected to direct loading at its center by a spherically shaped ram. During the test, the load and controlled displacement of the center of the test specimen is recorded. The toughness or energy of the panel (measured in Joules) is derived from the aggregate area under the load versus displacement curve. The energy is normally designated at a specified central deflection, usually 40 mm (1.6 in). The energy absorbed represents the ability of welded-wire-reinforced or fiber-reinforced shotcrete to redistribute stress following cracking, and therefore continue to offer structural support.

Mechanical Principle

As illustrated in Figure 72, the test sample is loaded in direct compression by the upper (force) platen and the lower three (reactant) pins of the test fixture. Flexural load capacity is determined based on sample first-break or post-first-break resistance (support capacity) at a given displacement.

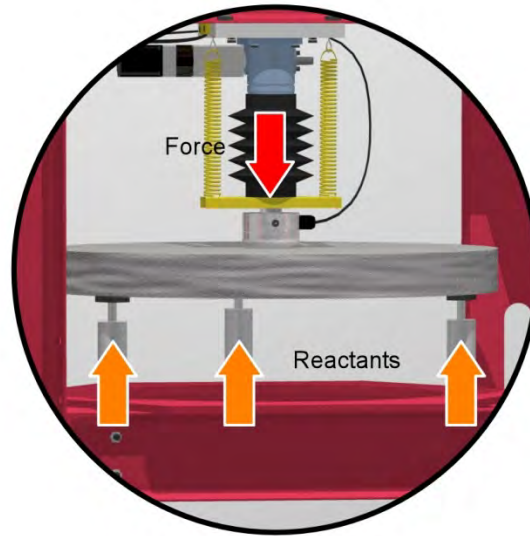

Figure 72. Diagram of the force applied to a round-panel shotcrete sample during an RDP test.

Performance Standard

Specified minimum values for load capacity are listed in Table 9 [AuSS 2008]. Typical specified minimum values for North American projects using the panel test for flexural load capacity first-break are 20 to 35 kN (4496.2 to 7,868.3 lbf) with residual load capacity of 6 kN (1,348.9 lbf) at 40-mm (1.6-in) displacement. Specified minimum values for toughness in mining and civil tunneling applications are listed in Table 10 and Table 11 [Morgan 1999; Papworth 2002; Pakalnis 2008]. A sample must break with a minimum toughness of 280 Joules as recommended by the New Austrian Tunneling Method (NATM) to be considered applicable for weak rock mass support [Barton and Morgan 1999]. The peak strength range also corresponds to 7%–15% of the compressive strength values obtained from traditional testing of cored samples [AuSS 2008; Bernard 2006].

Table 9. Typical minimum load capacity values specified for shotcrete in recent mining and civil engineering projects in North America for given ground support conditions and RDPT ram displacements, after AuSS [2008]

a. General ground support

RDPT ram displacement, mm (in)	Shotcrete load capacity, kN (lbf)
First break	20–25 (4,496.2–5,620.2)
10 (0.4)	11 (2,472.9)
20 (0.8)	9 (2,023.3)
30 (1.2)	7.5 (1,686.1)
40 (1.6)	6 (1,348.9)

b. Low-level ground support (nonstructural or low deformation)

RDPT ram displacement, mm (in)	Shotcrete load capacity, kN (lbf)
First break	20–25 (4,496.2–5,620.2)
10 (0.4)	7.5 (1,686.1)
20 (0.8)	6 (1,348.9)
30 (1.2)	4 (899.2)
40 (1.6)	3 (674.4)

c. Moderate-level ground support (moderate deformation)

RDPT ram displacement, mm (in)	Shotcrete load capacity, kN (lbf)
First break	25–30 (4,496.2–6,744.3)
10 (0.4)	17 (3,821.8)
20 (0.8)	12 (2,697.7)
30 (1.2)	9 (2,023.3)
40 (1.6)	6 (1,348.9)

d. High-level ground support (high deformation requiring wire mesh)

RDPT ram displacement, mm (in)	Shotcrete load capacity, kN (lbf)
First break	35 (7,868.3)
10 (0.4)	15 (3,372.1)
20 (0.8)	17 (3,821.8)
30 (1.2)	10 (2,248.1)
40 (1.6)	8 (1,798.5)

Table 10. Typical values specified for shotcrete toughness in recent mining and civil engineering projects in North America for given ground support conditions*

Level of ground support	Specified toughness (Joules) [†]
Low	280
Moderate	320
High	450

*Excerpts from modified Barton chart by Morgan [1999], Papworth [2002], and Pakalnis [2008]

[†]RDPT energy determined at 40 mm (1.6 in) of deflection using ASTM C1550 [2010]

Table 11. Comparison of shotcrete toughness performance level to Q-system rock class, RDPT energy, ground support reinforcement category, and RMR for recent mining projects in North America*

TPL [†]	Rock class	Energy, Joules [‡]	Ground support	RMR
IV	F	560	8+	0–10
IV	E	400	7	10–25
III	D	280	6	25–45
II	C	200	5	45–55
I	B	200	5	45–55
0	A	0	4	55–80

*Excerpts and modified Barton chart from Morgan [1999], Papworth [2002], and Pakalnis [2008]

[†]TPL = Toughness Performance Level

[‡]RDPT energy determined at 40 mm (1.6 in) of deflection using ASTM C1550

Description of Apparatus

Round panels must be tested in a suitable servo-controlled machine in order to comply with the test standard listed in ASTM C1550 [2010]. NIOSH researchers designed a portable round panel test machine for use onsite at mines (Figure 73 and Figure 74). The unit and apparatus applies a compressive load at a fixed displacement rate. The device is comprised of a portable, self-contained, servo-controlled, stiff-frame press with advanced load-rate and load-collection capability. There is a load output display with an appropriate scale and resolution, along with a current state of energy output. The machine resolution is 0.45 kg (1 lb) over a 10,886 kg (24,000 lb) operating range. A programmable-logic-controller (PLC) driven machine head applies a displacement rate of 4.0 mm/min (0.16 in/min) with an auto return after 45 mm (1.8 in) of displacement [ASTM 1550 (2010)]. The automated load cycle greatly reduces the chance of human error and the time to conduct a standard test.

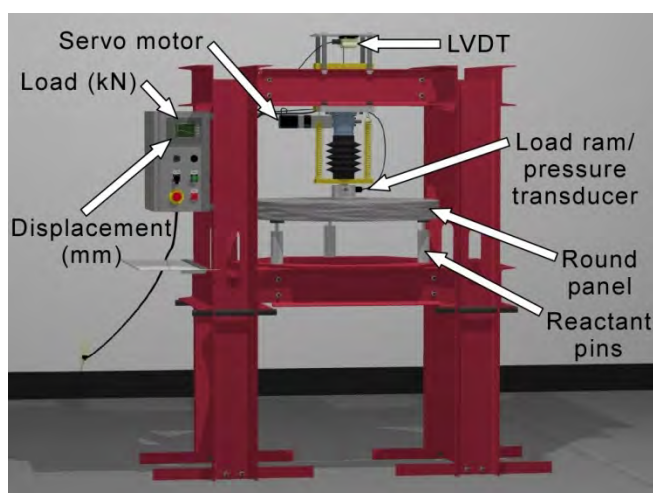

Figure 73. Schematic of a portable round determinate panel (RDP) test machine developed by NIOSH researchers.



Figure 74. Operation of portable round determinate panel (RDP) test machine.

Test Procedure

The ASTM 1550 [2010] testing protocol calls for sample preparation and testing of shotcrete mixes to be sprayed into 75 x 800-mm (3 x 31.5-in) mold rings to create round-panel test specimens (Figure 75). The samples must be carefully prepared to meet the required specifications concerning flatness, thickness, and diameter. For example, the top surface of the sprayed panel must be screeded to a flatness tolerance of at least 5 mm (0.2 in). The sample must also have a thickness of 70 to 90 mm (2.75 to 3.5 in) and a diameter of 750 to 850 mm (29.5 to 33.5 in). Correction factors are available when variances in the thickness and diameter occur. The round-panel mold rings should be secured to a stable base of sufficient thickness to prevent vibration, and the overall form (mold ring and base) should be oriented at a 45° angle to reduce the amount of rebound that will build up in the mold (Figure 76). Measures should be taken to achieve a dense and homogeneous shotcrete without segregation, sloughing, collapsing, excessive rebound, or other visible imperfections.

Based on ASTM C1550 [2010], a minimum of two round panel samples should be tested. However, at least three round panel samples should be sprayed in case one is damaged prior to testing. RDP tests are normally conducted after the round panel samples have cured for 7, 14, or 28 days. After the tests are conducted, the round panel samples should be inspected to ensure that the tolerances for specimen thickness have been achieved and that the exposed cross section of the sample is free of defects such as voids, lenses, and poorly consolidated regions.

If a comparative compressive strength of the fiber-reinforced shotcrete is required, a 1.2 x 1.2 x 0.24-m (4 x 4 x 0.8-ft) panel-shaped sample can be sprayed and 76.2-mm (3-in) diameter x 152.4-mm (6-in) long cores extracted in accordance with ASTM C1140 [2003] and tested in accordance with ASTM C1609 [2010].



Photo by NIOSH

Figure 75. Mold ring used to prepare a round-panel shotcrete sample.



Photo by NIOSH

Figure 76. Sprayed round-panel shotcrete samples.

After the round panel samples have been sprayed, the specimens are allowed to cure. The shotcrete test panels are then carefully demolded by disassembling the mold ring fixtures and removing the enclosed samples. After curing for a designated period of time at ASTM specifications, the sample is positioned on a three-pin test fixture and centered under the loading head of the RDP test machine. The loading head is then lowered to a position just above the upper surface of the round panel sample using a manual toggle switch (Figure 77).

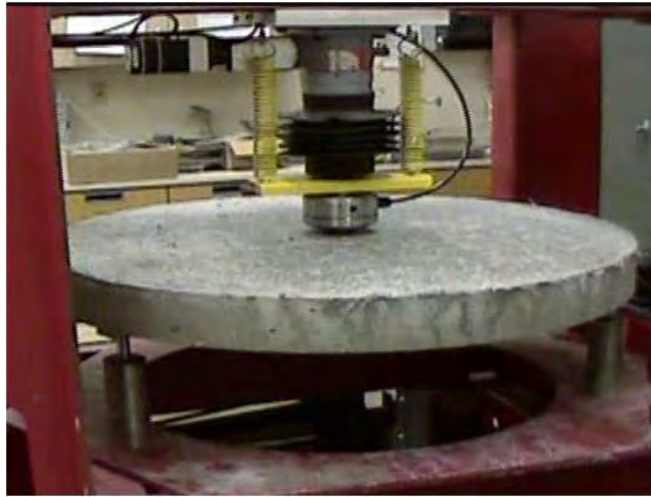

Photo by NIOSH

Figure 77. Round-panel shotcrete sample positioned in portable RDP test machine.

To conduct a test, the green start switch is depressed initiating the automated test cycle, whereupon a PLC-controlled press loads the sample at a fixed displacement rate. The load profile is shown on a graphical output display, and the measured test parameters (time, displacement, and load) are stored on a thumb drive. The sample is tested to failure as indicated by the appearance and development of three distinct tension cracks in the sample. The RDP test continues until the loading ram has moved a minimum of 40 mm (1.6 in) from its initial starting position (Figure 78). These tension cracks usually develop at less than 5 mm (0.2 in) of ram displacement. The operator will typically observe a well-defined peak in the load profile curve, indicating the first break load capacity of the sample.

After the 40-mm (1.6-in) test cycle is completed, the loading ram automatically retracts to unload the broken sample. Next, the round panel sample is removed from the RDP test machine, and it is broken apart to expose the failure surfaces along the tensile cracks. The thickness of the panel sections are then measured at ten locations. The failure surfaces exposed on the panel sections are closely examined to determine the distribution and quantity of the fibers in the applied shotcrete, and a fiber count is conducted along each broken section of the panel and recorded (Figure 79). Using this procedure, RDP tests are conducted with three round panel samples, ensuring that the results from at least two of the tests can be used for analysis.

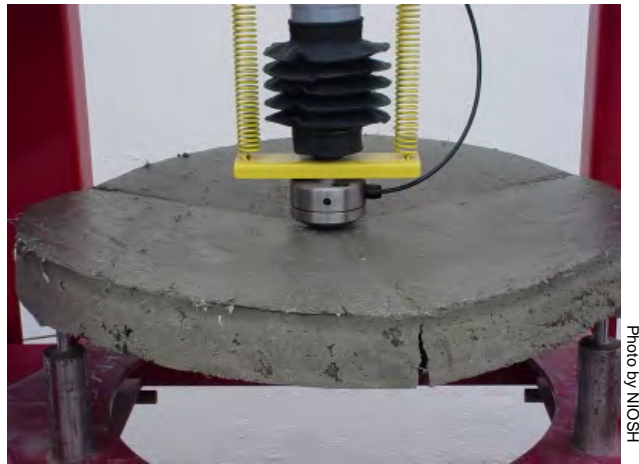

Figure 78. Broken round-panel test sample showing tension cracks.



Figure 79. Synthetic macro fibers exposed along the failure surface of round-panel shotcrete sample.

Observations, Anomalies, and Influencing Factors During RDP Tests

The RDP test produces a determinate set of three tensile cracks along hinge lines spaced about 120° apart as shown in Figure 80. As the test progresses and the deflection in the panel increases, these tensile cracks open on the underside of the panel, exposing the fibers in the shotcrete which bridge the crack. Note the nonuniform surface in the lower left section of the shotcrete panel in Figure 80. The presence of voids in the sample usually indicates that a nozzle operation problem has occurred during the spraying of the shotcrete sample. Any shotcrete application problem needs to be corrected to ensure that valid test results are obtained from the round panel samples. It is important that representative test samples are prepared in order for the RDP test results to realistically reflect the in-place strength properties of the bulk shotcrete product. As an example, a drawing of a typical roof bolt pattern for an underground opening is shown in Figure 81 along with a superimposed RDP test panel illustrating the flexural loading of the shotcrete that is assumed to occur between the bolts.

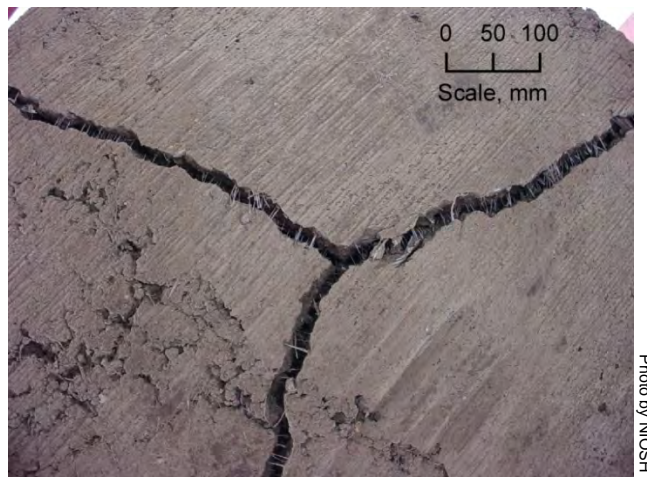

Figure 80. Broken round panel sample of fiber-reinforced shotcrete showing the 120° cracks.

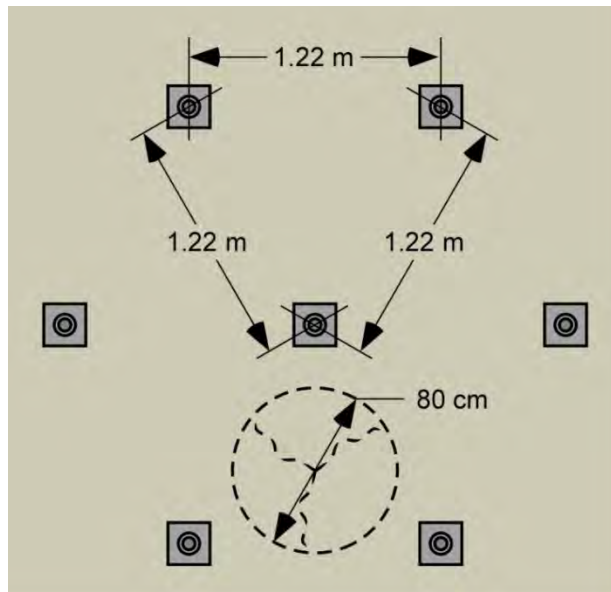

Figure 81. Typical roof bolt pattern with a superimposed RDP test panel showing the assumed flexural loading of the shotcrete between the bolts.

Fiber Count and Distribution

The fiber count or fiber dosing of the reinforced shotcrete can be determined by counting the fibers in a cross section of the post-tested panel. This method is used only when determining fiber content for steel and macro-synthetic fibers. The cross section of the panel should be inspected for even dispersion of the fibers.

Analysis of Round Determinate Panel (RDP) Test Results

After conducting an RDP test, a load versus displacement profile is obtained from the test as shown in Figure 82. The peak flexural load can be easily identified from the graph. The residual load capacity is denoted by the load values after the peak flexural load and represents the load that the shotcrete can still support at specific displacement intervals. These are separate from the displacement at peak flexural load.

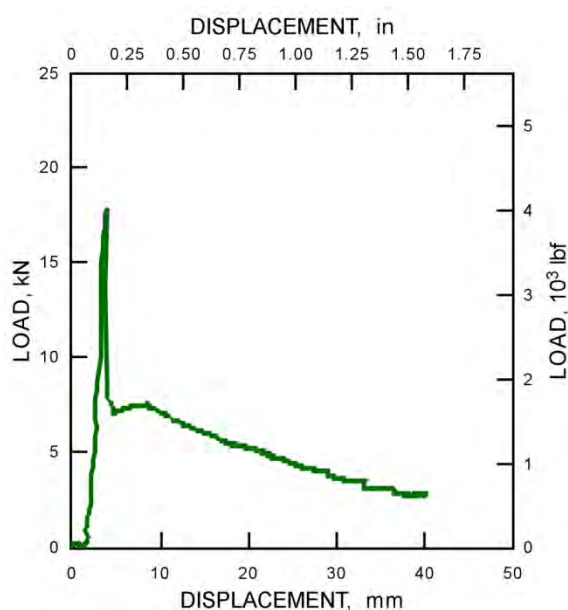

Figure 82. Load versus displacement curve from RDP test.

After the peak flexural load has been developed, the panel undergoes a first break or an initial failure of the cemented material. Once this first break occurs, the cementitious matrix is no longer the primary load-carrying component of the shotcrete. Instead, the cross-sectional area of the reinforcement component in the shotcrete (e.g., steel fiber, synthetic macro fiber, or wire mesh) begins to carry the applied load. Although the first break usually occurs immediately after the peak flexural load, the timing of this event is somewhat variable as indicated by the first break bandwidth shown in Figure 83.

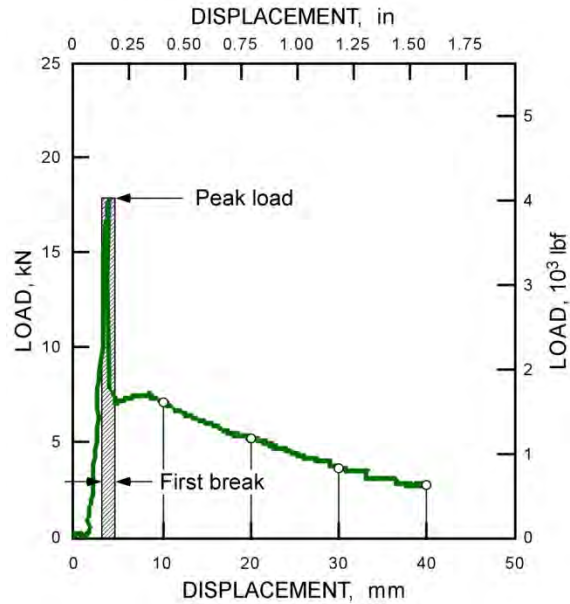

Figure 83. Load versus displacement curve from RDP test indicating peak load and first break.

The area under the load-displacement curve from 0 to 40 mm (0 to 1.6 in) of displacement is referred to as the energy absorption or toughness of the shotcrete. This shotcrete property is indicated by the green shaded area beneath the load-displacement curve shown in Figure 84.

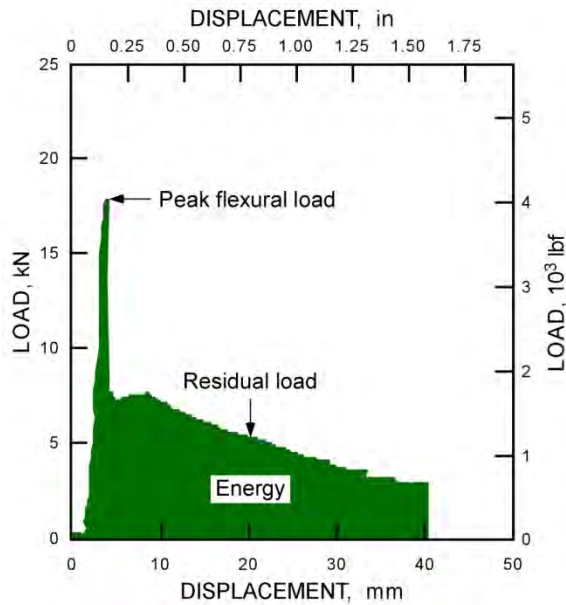

Figure 84. Load versus displacement curve from RDP test indicating peak load, residual load, and the energy or toughness of the shotcrete.

With displacement, the energy capacity or toughness increases as the residual load decreases through 40 mm (1.6 in) of displacement (Figure 85).

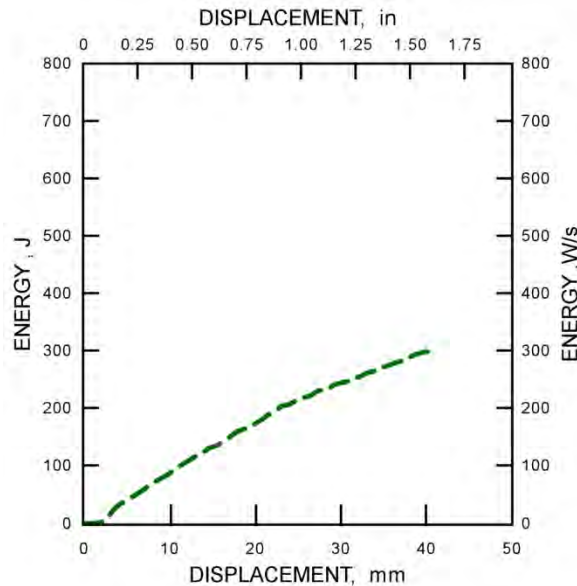

Figure 85. Energy versus displacement curve from RDP test.

Field Verification of Test Method and Apparatus for Determining the Flexural Strength of Shotcrete Using the Round Determinate Panel Test (RDPT) Method

Background

The RDP test machine commissioning trials consisted of flexural strength testing of onsite, as-sprayed shotcrete samples over a range of 8-hrs to 28-days curing time. All collection of samples and testing of shotcrete material properties were conducted in accordance with the requirements of the ASTM C1550 test [2010]. The usefulness of this field-ready test machine had been previously documented during a shotcrete fiber dosage comparison study conducted at the Chief Joseph Mine in Butte, Montana, [Martin et al. 2007] and Devil’s Slide Tunnels Project near Pacifica, California [Decker et al. 2010].

Specific Trials and Locations

The RDP test machine commissioning trials consisted of a series of field tests that were conducted at multiple mine sites, one tunnel site, and one shotcrete producer’s site. A first set of tests was conducted at the Rockwell Mine in Greybull, Wyoming to determine the effect of batch source water on peak load using either mine or well-water sources, and additional tests were conducted to determine the effect of welded wire mesh on flexural load capacity. A second set of tests was conducted on a mix intended for use at the Kensington Mine near Juneau, Alaska, and the Pogo Mine located near Delta Junction, Alaska. These tests were conducted at Central Pre-Mix, Spokane Valley, Washington to determine if a target shotcrete design criteria, an optimum design energy for safe ground support, could be achieved in 24 hrs through the manipulation of the cement dosage rate. A third set of tests was conducted on civil engineering shotcrete mix blends intended for use in extreme ground conditions. Engineers for the Kiewit Corporation, working under contract for the California Department of Transportation at the Devil’s Slide Tunnels Project, contacted NIOSH personnel about using the newly developed, portable RDPT

machine to validate mix designs for shotcrete reinforced with synthetic fiber. RDP tests were conducted at the Devil's Slide Tunnels site near Pacifica, California to determine the effect of synthetic fiber dosage on total energy absorption. A final set of tests was conducted at Newmont Mining Corporation's Leeville Mine near Carlin, Nevada to determine the effect of different reinforcement, welded wire mesh and fiber (both type and dosage), on the flexural load capacity for weak rock mass shotcrete.

Rockwell Mine, Greybull, Wyoming

The goal of this set of tests was to identify if the batching source water, either well water or mine waste water, significantly affects the shotcrete load capacity. The secondary goal of this set of tests was to determine the flexural load capacity for shotcrete reinforced with welded wire mesh using either type of mix water.

The mix designs were blended by Thiessen Team USA and consisted of a typical dry mix design superstick with water additive (SCA) and superstick water accelerant with corrosion resistance (SCACR). The specific mixes tested were SCACR/well water and SCACR/well water with wire mesh, and SCACR/mine water mix. These mixes were blended at the Big Timber, Montana, shotcrete plant and shipped to the Greybull, Wyoming, mine site for testing.

The research team from NIOSH prepared 15 panels at the mine facility with five panels for each of the three mix designs. All of the previously mentioned panels were tested for 8-hr strengths. In addition, 12 test panels were shot for 28-day strength testing (Figure 86). These round panels were stored underground at the mine.



Photo by NIOSH

Figure 86. Spraying round-panel shotcrete samples reinforced with wire mesh.

The shotcrete round panels were mounted on pallets for ease of handling, then set at 40°–45° to the horizontal against blocking outside the mine. The panels were washed and degreased, then the shotcrete was shot into the panels by a certified nozzle operator using an Aliva 242.5 machine (Figure 87). The water was added using a special wetting nozzle at the clamp intersection instead of the nozzle hose intersection. Compressed air was supplied from an 18.4-m³/m (650-cfm) two-stage compressor. The water was distributed using a water pump on a water truck. The shot panels varied up to 3 mm (0.12 in) in thickness. This is typical for stiff shotcrete mix with a 127-mm (5-in) slump. After each mixture was shot, the pot and hose were cleaned.

Temperature has an effect on the curing of the shotcrete due to the additives used; this in turn has a direct impact on the strength of the shotcrete over the curing time. Shotcrete with additives are thermally dependent for their manufacturing listed cure times. Therefore, concrete insulation blankets were applied at the completion of shooting to keep the panels from freezing, and were left on the panels for 8 hrs.

The curing of the panels was performed at in-mine conditions located in a laydown area. The shotcrete was applied at an ambient air temperature of between 0°C (32°F) and 7.2°C (45°F), and a round panel form temperature of 26.6°C (80°F). The final shotcrete temperature as applied with water and compressed air to the forms was measured at 21.1°C (70°F).



Photo by NIOSH

Figure 87. Spraying round panel forms with a dry mix shotcrete.

Trial Results

Mine staff were interested in duplicating the flexural load capacity documented through previous NIOSH tests with polyfiber shotcrete [Martin et al. 2007]. Figure 88 and Figure 89 show the results of the 8-hr round panel tests with the two types of water. The shotcrete using mine water developed a higher peak load than the well-water shotcrete.

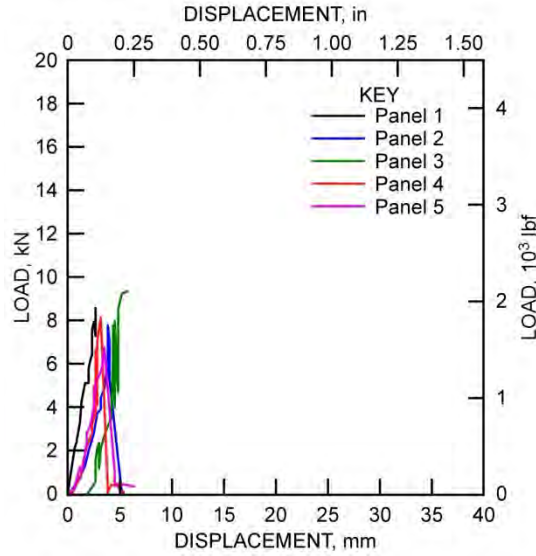

Figure 88. Comparison of load versus displacement curves for SCACR shotcrete mixed with well water and cured for 8 hours.

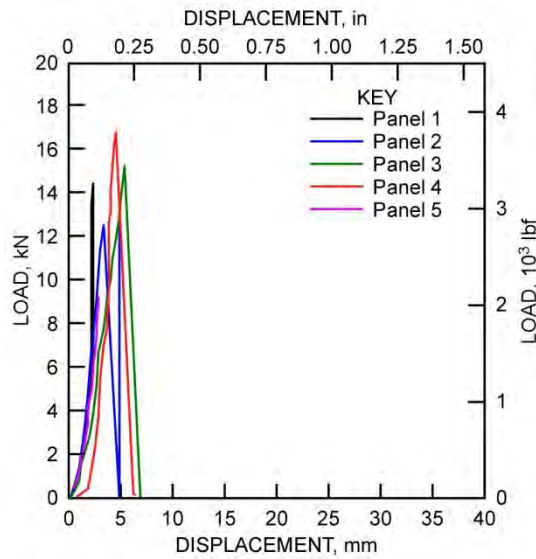

Figure 89. Comparison of load versus displacement curves for SCACR shotcrete mixed with mine water and cured for 8 hours.

Mine ground control staff determined that SCACR batched with well-water shotcrete panels containing the welded wire mesh would be tested due to the abundance and ease of acquiring the well water. The other panels with mine water were not tested. The results of the 28-day round panel tests using this mix design and welded wire mesh reinforcement are shown in Figure 90.

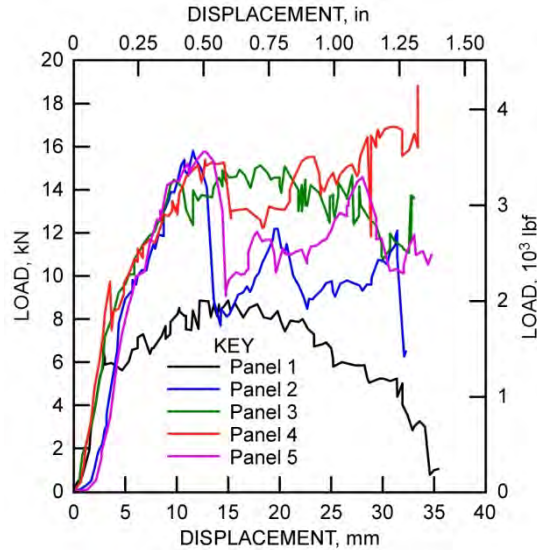

Figure 90. Comparison of load versus displacement curves for SCACR shotcrete mixed with well water, reinforced with wire mesh, and cured for 28 days.

The panels in this test series have a somewhat lower first-break load and an erratic loading pattern. This low load could be due to the cold temperatures in which the panels were shot and cured. The usual deflection of 40 mm (1.6 in) as run by the industry is to allow for the polyfibers to develop an energy requirement before fiber pullout. However, the mine ground control staff determined that 25.4 mm (1.0 in) of deflection instead of the typical 40 mm (1.6 in) would be their allowable deflection with wire mesh before rehabilitation of the ground support would occur. Therefore, the tests were carried out to only 35 mm (1.4 in) to show loading trends beyond the mine’s design requirements. The average peak load is 13.4 kN (3,012.4 lbf), and the average residual is around 8.9 kN (2,000.8 lbf) at 35 mm (1.4 inches) of deflection. The combination of SCACR shotcrete mix, well water, and welded wire mesh reinforcement can achieve the load of 6 kN (1,348.9 lbf) at 35 mm (1.4 inches) of deflection. This support value meets typical load capacity specifications for weak rock mass ground support.

Pogo and Kensington Mines

Purpose of the Tests

The goal of this set of tests was to determine the effect of cement dosage on flexural load capacity. Two wet mixes specifically designed for use in the Pogo and Kensington mines in Alaska were compared for initial flexural strength. The wet mixes were batched using 295 kg (650 lb) of Portland cement per ton for Pogo and 318 kg (700 lb) for Kensington. Due to the nature of the mix and the competitive bid market, the mix design is not published, but is available from Central Pre-Mix, Spokane Valley, Washington.

Sample Preparation and Testing

The test panels were shot by a certified nozzle person (Figure 91) at the Central Pre-Mix site with a swing-type positive displacement pump (Figure 92). Five samples of each blend were sprayed into molds and then blanketed to retain heat to simulate the in-mine conditions typical of Alaskan applications for the 24-hour curing process.



Figure 91. Spraying round panel forms with wet mix shotcrete.



Figure 92. Swing-type, positive-displacement pump used to apply wet mix shotcrete.

The testing was conducted to determine peak load and residual load capability at 80 mm (3 in) of displacement rather than the standard displacement of 40 mm (1.6 in). Toughness calculations were not considered due to the freshness of the Portland cement in the 24-hr tests.

Trial Results

The results of the 24-hr tests show that the 318-kg (700-lb) mix with an average peak load of 8.9 kN (2,000.8 lbf) was significantly stronger than the 295-kg (650-lb) mix with an average peak load of 1.8 kN (404.7 lbf) (see Figure 93 and Figure 94). This strength differential was also reflected in the residual strength characteristics. Further, the 295-kg (650-lb) mix samples broke under their own weight after testing. The 318-kg (700-lb) mix samples had to be broken with a hammer to be removed from the test frame.

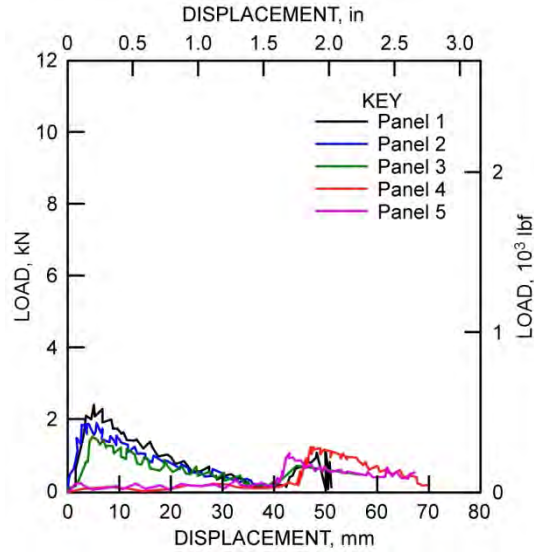

Figure 93. Comparison of load versus displacement curves for 295-kg (650-lb) mix with 24-hour cure time.

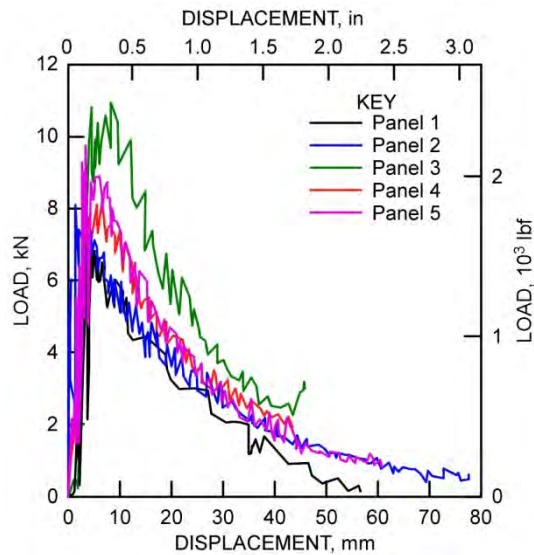

Figure 94. Comparison of load versus displacement curves for 318-kg (700-lb) mix with 24-hour cure time.

Devil's Slide Tunnels Project, Pacifica, California

Purpose of the Tests

The goal of this set of tests was to determine the effect of synthetic fiber dosage on total energy absorption. Tests were conducted on civil engineering shotcrete mix blends that were developed from the mining industry's Shogun[®] fiber mix intended for use in extreme ground conditions [Martin et al. 2011]. Testing was conducted in cooperation with Kiewit engineering staff at the Devil's Slide Tunnels Project near Pacifica, California.

Sample Preparation and Testing

The panels for the Devil’s Slide Tunnels Project were shot onsite by a certified nozzle operator using a swing-style, positive-displacement pump and a wet-mix shotcrete reinforced with Barchip Shogun fiber. The shotcrete was mixed in an onsite batch plant using the blend of constituents listed in Table 12. This polyfiber shotcrete mix design was developed to address the weak ground conditions at the Devil’s Slide Tunnels site. A synthetic fiber dosage of 5 kg/m³ (8.5 lb/yd³) was used to achieve a recommended shotcrete toughness of 320 Joules at 40-mm (1.6-in) of displacement as required for class III and higher ground conditions by the Norwegian Concrete Association [NCA 2007] and the New Austrian Tunneling Method [NATM 1962]. The Kiewit tests were conducted in compliance with ASTM C1550 [2010]. The samples were cured for 7 days under ASTM-recommended conditions before being tested. A total of three round-panel samples were prepared. The first two tests exceeded the shotcrete toughness requirements; therefore, the third panel was not tested.

Table 12. Proportions of various mix constituents for round-panel shotcrete samples at the Devil’s Slide Tunnels Project

Mix constituent	Amount, kg/m ³ (lb/yd ³)*	Product, supplier, or comment
Synthetic macro fiber	5 (8.5)	Barchip Shogun
10-mm aggregate	478 (806)	Vulcan
Quarry sand	1,235 (2,082)	Sechelt
Cement	446 (752)	Hanson type II-V
Water	178 (300)	na [†]
Water-to-cement ratio	na	0.40
Water reducer	2.9 L (3.2 qt)	BASF Rheobuild 1000
Set-retarding admixture	0.58 L (0.6 qt)	BASF Delvo Stabilizer
Slump of mixes	na	38 mm (1.5 in)

*Unless listed otherwise as liters and quarts

[†]na = not applicable

Trial Results

The typical results of the tested panels are shown in Figure 95. The Shogun synthetic-fiber-dosed shotcrete formulated for use in extreme ground conditions achieved a peak load of 25 kN (5,620.2 lbf) which has an energy capacity of 400 Joules at 40-mm (1.6-in) displacement (Figure 95). This exceeds the project design requirements of 320 Joules of toughness at only 7-days curing time. For comparison, it should also be noted that the slump of the mix was at a relatively stiff mix at 38 mm (1.5 in), as compared to a typical 127 to 178-mm (5 to 7-in) slump.

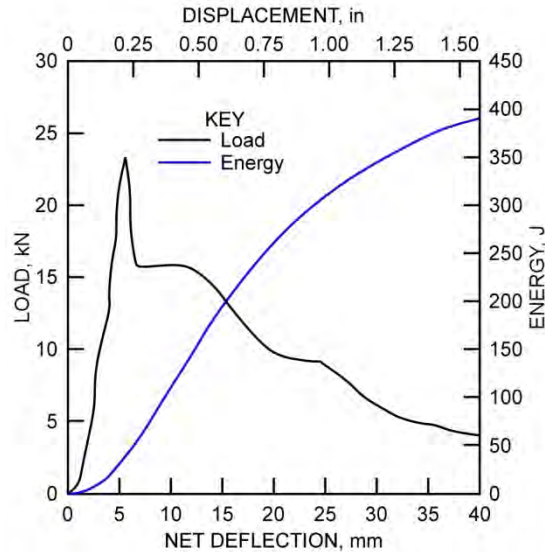

Figure 95. Load versus displacement and energy versus displacement curves for 5-kg/m³ (8.5-lb/yd³) Shogun fiber mix with 7-day cure time.

Leeville Mine, Carlin, Nevada

Purpose of the Tests

The goal of this set of tests was to determine the effect of different reinforcement types, including welded wire mesh and fiber (both type and dosage), on flexural load capacity for weak rock mass shotcrete. The testing was conducted at Newmont Corporation's Leeville Mine near Carlin, Nevada.

Sample Preparation and Testing

The mine provided a wet mix shotcrete that was designed by Modern Concrete in Carlin, Nevada to conform with the American Concrete Institute (ACI) specifications for shotcrete blends [ACI 506R-05]. The mix was reinforced with either welded wire mesh or fiber in accordance with ACI 506.1R-98 [1998]. Round-panel forms were sprayed on the surface of the mine site using a wet-mix shotcrete machine equipped with a robotic manipulator-arm (Figure 96). Samples of the welded wire mesh were cut to fit into the round panel forms, and the legs of the mesh wires were bent down to position the mesh in the middle of the panel, similar to its use in underground mines. The samples were collected and cured under wet burlap in a sample storage room at saturated conditions in accordance with ASTM standards.



Figure 96. Shooting wet mix shotcrete into a round panel form with wire mesh reinforcement.

Shotcrete Constituents

The blends that were used in the panel tests are shown in Table 13. Two round panel samples were prepared and tested for all Shogun fiber mix designs, including 1.87 kg/m^3 (3.15 lb/yd^3), 2.99 kg/m^3 (5.0 lb/yd^3), 4.12 kg/m^3 (7.0 lb/yd^3), six samples, plus the welded wire mesh and the Performax[®] fiber mix of 2 samples each. In some cases, additive mixtures were also incorporated and are documented in the tables and graphs.

The samples were tested in conformance with the requirements of ASTM C1550 [2010] for toughness over 40 mm (1.6 in) of displacement. Testing was initially proposed on samples that had cured for 8 and 24 hours. However, the 8-hr and 24-hr samples were not strong enough to be tested. As a result, only the 28-day tests were conducted.

Table 13. Proportions of various mix constituents for round-panel samples of reinforced shotcrete at the Leeville Mine

a. 1.87 kg/m³ (3.15 lb/yd³) of Shogun fiber

Mix constituent	Amount, kg/m³ (lb/yd³)*	Product, supplier, or comment
Synthetic macro fiber	1.87 (3.15)	Barchip Shogun
10-mm aggregate	146 (247)	Modern Concrete
Quarry sand	831 (1,402)	Modern Concrete
Cement	236 (398)	Ashgrove Corporation
Water	143.3 (242)	na [†]
Water-to-cement ratio	na	0.54
Water reducer	1.5 L (1.6 qt)	BASF Glenium 3030
Accelerator	11.4 L (12.0 qt)	BASF MEYCO SA 430
Slump of mixes	na	171 mm (6.75 in)

*Unless listed otherwise as liters and quarts

[†]na = not applicable

b. 2.99 kg/m³ (5.0 lb/yd³) of Shogun fiber

Mix constituent	Amount, kg/m³ (lb/yd³)*	Product, supplier, or comment
Synthetic macro fiber	2.99 (5.0)	Barchip Shogun
10-mm aggregate	146.75 (247.4)	Modern Concrete
Quarry sand	831.57 (1,402)	Modern Concrete
Cement	263.13 (444)	Ashgrove Corporation
Water	135.5 (228.4)	na [†]
Water-to-cement ratio	na	0.52
Water reducer	1.5 L (1.6 qt)	BASF Glenium 3030
Accelerator	11.4 L (12.0 qt)	BASF MEYCO SA 430
Slump of mixes	na	165 mm (6.5 in)

*Unless listed otherwise as liters and quarts

[†]na = not applicable

c. 4.12 kg/m³ (7.0 lb/yd³) of Shogun fiber

Mix constituent	Amount, kg/m ³ (lb/yd ³)*	Product, supplier, or comment
Synthetic macro fiber	4.12 (7.0)	Barchip Shogun
10-mm aggregate	146.75 (247.4)	Modern Concrete
Quarry sand	831.57 (1,402)	Modern Concrete
Cement	263.13 (444)	Ashgrove Corporation
Water	139.9 (235.8)	na [†]
Water-to-cement ratio	na	0.53
Water reducer	1.5 L (1.6 qt)	BASF Glenium 3030
Accelerator	11.4 L (12.0 qt)	BASF MEYCO SA 430
Slump of mixes	na	140 mm (5.5 in)

*Unless listed otherwise as liters and quarts

[†]na = not applicable

d. Six-gauge wire mesh

Mix constituent	Amount, kg/m ³ (lb/yd ³)*	Product, supplier, or comment
10-mm aggregate	141.31 (698.5)	Modern Concrete
Quarry sand	800.75 (1,349.8)	Modern Concrete
Cement	280.67 (473.2)	Ashgrove Corporation
Water	139.6 (235.4)	na [†]
Water-to-cement ratio	na	0.50
Accelerator	11.4 L (12.0 qt)	BASF MEYCO SA 430
Slump of mixes	na	127 mm (5 in)

*Unless listed otherwise as liters and quarts

[†]na = not applicable

e. Six-gauge wire mesh plus water-reducing admixture

Mix constituent	Amount, kg/m³ (lb/yd³)*	Product, supplier, or comment
10-mm aggregate	146.75 (247.4)	Modern Concrete
Quarry sand	831.57 (1,402)	Modern Concrete
Cement	263.13 (443.6)	Ashgrove Corporation
Water	151.6 (255.6)	na [†]
Water-to-cement ratio	na	0.58
Water reducer	1.5 L (1.6 qt)	BASF Glenium 3030
Accelerator	11.4 L (12.0 qt)	BASF MEYCO SA 430
Slump of mixes	na	171 mm (6.75 in)

*Unless listed otherwise as liters and quarts

[†]na = not applicable

f. 1.87 kg/m³ (3.15 lb/yd³) of Performax fiber

Mix constituent	Amount, kg/m³ (lb/yd³)*	Product, supplier, or comment
Synthetic macro fiber	1.87 (3.15)	Performax
10-mm aggregate	146.75 (2,474)	Modern Concrete
Quarry sand	831.57 (1,402)	Modern Concrete
Cement	263.13 (443.6)	Ashgrove Corporation
Water	148.5 (250.4)	na [†]
Water-to-cement ratio	na	0.56
Water reducer	1.5 L (1.6 qt)	BASF Glenium 3030
Accelerator	11.4 L (12.0 qt)	BASF MEYCO SA 430
Slump of mixes	na	159 mm (6.25 in)

*Unless listed otherwise as liters and quarts

[†]na = not applicable

Trial Results

The results of both round panels tested for each of the given mix designs are included in the following set of figures. Figure 97 through Figure 99 are the load-displacement and energy curves for the mix designs containing the Shogun fiber at dosage rates of 1.87 kg/m³ (3.15 lb/yd³), 2.99 kg/m³ (5.0 lb/yd³), and 4.12 kg/m³ (7.0 lb/yd³).

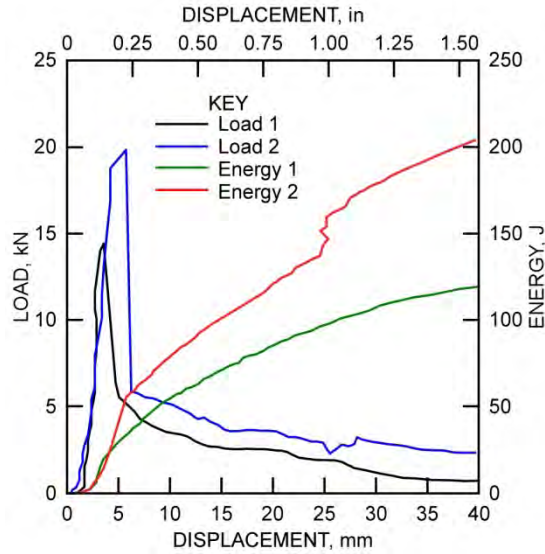

Figure 97. Comparison of load versus displacement and energy versus displacement curves for 1.87-kg/m³ (3.15-lb/yd³) Shogun fiber mix with 28-day cure time.

In Figure 97 the load and energy curves for the Shogun fiber dosage at 1.87-kg/m³ (3.15-lb/yd³) mix indicate an average first break load of 17 kN (3,821.8 lbf), though there is some variability between the strengths. Both samples maintained some residual load throughout the 40 mm (1.6 in) of displacement. The toughness, however, never reached the 280 Joules recommended by NATM for weak rock mass support. When comparing the results of the two samples, a small difference in the residual load can result in a large difference in the energy at 40 mm (1.6 in). It should also be noted that this mix had a slump of 171.4 mm (6.75 in).

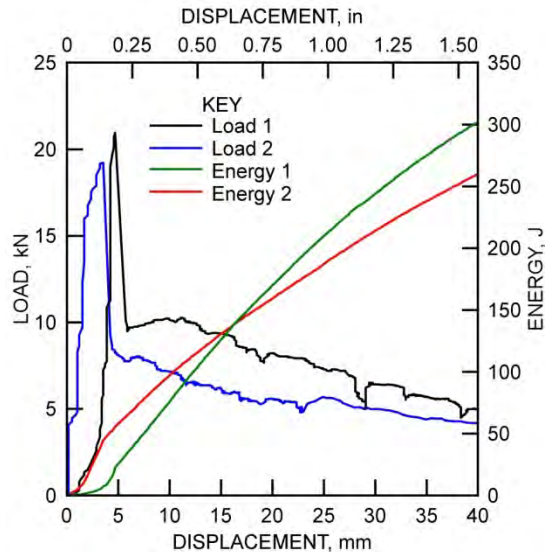

Figure 98. Comparison of load versus displacement and energy versus displacement curves for 2.99-kg/m³ (5.0-lb/yd³) Shogun fiber mix with 28-day cure time.

For the 2.99-kg/m³ (5.0-lb/yd³) Shogun mix, the peak load and energy was superior to the 1.87-kg/m³ (3.15-lb/yd³) mix at 28 days. The first break load averaged about 20 kN (4,496.2 lbf), which is just slightly higher than the lower fiber dose samples. However, the residual loads through 40 mm (1.6 in) of displacement are much higher, thus resulting in an average of 280 Joules of energy. This toughness meets the recommended values for weak rock mass ground control. Also, a load greater than 6 kN (1,348.9 lbf) was achieved at 25 mm (1 in) of displacement, which corresponds to design criteria for weak rock mass suggested by Pakalnis [2010]. The slump at 165.1 mm (6.5 in) was stiffer by 6.3 mm (0.25 in) than the lower dose mix.

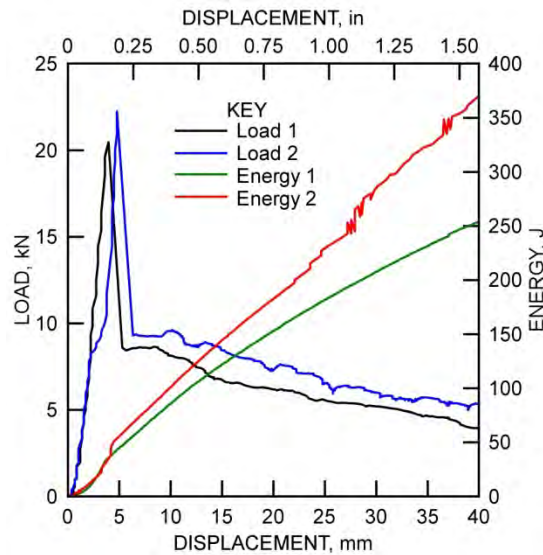

Figure 99. Comparison of load versus displacement and energy versus displacement curves for 4.1-kg/m³ (7.0-lb/yd³) Shogun fiber mix with 28-day cure time.

The results of tests at 28 days for shotcrete with a fiber dosage of 4.1-kg/m³ (7.0-lb/yd³) Shogun fiber mix indicate that this mix and dosage formulation exceeded the toughness requirements of 280 Joules energy recommended for weak rock mass support [Pakalnis 2010]. The first-break strength was 20 kN (4,496.2 lbf), with both samples having similar load profiles. Additionally, at 40 mm (1.6 in) of displacement the residual load is 6 kN (1,348.9 lbf). There was only a small gain in the peak load, residual load, and energy at 40 mm (1.6 in) over that of the 2.99-kg/m³ (5.0-lb/yd³) fiber dose, which suggests that there is a limit to the effect of the fiber dosage. It should also be noted that this mix had a slump of 139.7 mm (5.5 in), which was the stiffest of the three mixes.

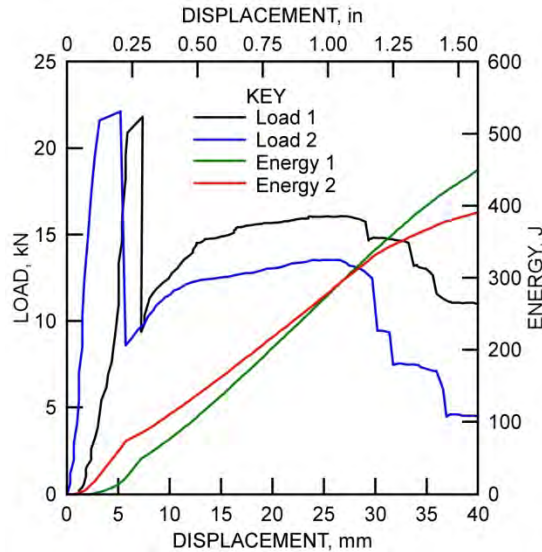

Figure 100. Comparison of load versus displacement and energy versus displacement curves for shotcrete reinforced with six-gauge wire mesh and cured for 28 days.

In Figure 100 the load-displacement and energy curves are shown for the two panels with the welded wire mesh with no additives. The measured flexural load capacity for tests conducted with welded wire mesh is of particular interest to underground mines because this supermesh support system is currently being used in weak rock conditions. The shape of the load-displacement and energy curves after the peak load is significantly different than the curves previously shown for the fiber-reinforced panels. Both welded wire mesh panels without the additive have similar load-displacement curves. Further, the developed average toughness at 450 Joules far exceeds the 280 Joules recommended for weak rock mass support [Pakalnis 2010]. The panels were capable of holding 6 kN (1,348.9 lbf) at 40 mm (1.6 in) for a mix with a slump of 127 mm (5 in).

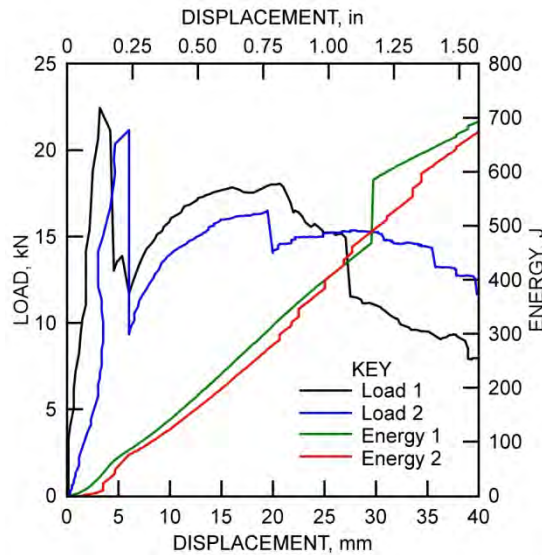

Figure 101. Comparison of load versus displacement and energy versus displacement curves for shotcrete with a water-reducing admixture that is reinforced with six-gauge wire mesh and cured for 28 days.

As shown by the load-displacement and energy curves in Figure 101, 700 Joules of toughness was measured for the two panels with welded wire mesh reinforcement and additives. This toughness level exceeds the 280 Joules of energy recommended by Pakalnis [2010] for ground support in weak rock mass mines. There was an increase in the total energy of almost 200 Joules when compared to the wire mesh panels without the admixture I accelerant. Additionally, the residual load at 40 mm (1.6 in) exceeded the 6 kN (1,348.9 lbf) as required for dead weight loads in weak rock mass mines [Martin et al. 2010]. This mix design had a slump of 171.5 mm (6.75 in) as compared to 127 mm (5 in) for the welded wire mesh panels without the admixtures, thus showing the effects of admixtures.

Furthermore, Figure 102 shows the load-displacement and energy curves for the two panels with the Performax fiber mix. The Performax fiber mix panels made with a fiber dose of 1.87 kg/m^3 (3.15 lb/yd^3) showed a very similar performance as the Shogun fiber mix panels with the same fiber dosage in terms of the peak load, and the energy and residual load at 40 mm of displacement (Figure 97). The Performax fiber mix, however, has a more consistent load and energy profile than the Shogun fiber mix with the same dosage. The slump at 158.8 mm (6.25 in) was a little stiffer than the corresponding Shogun mix by 13 mm (0.5 in).

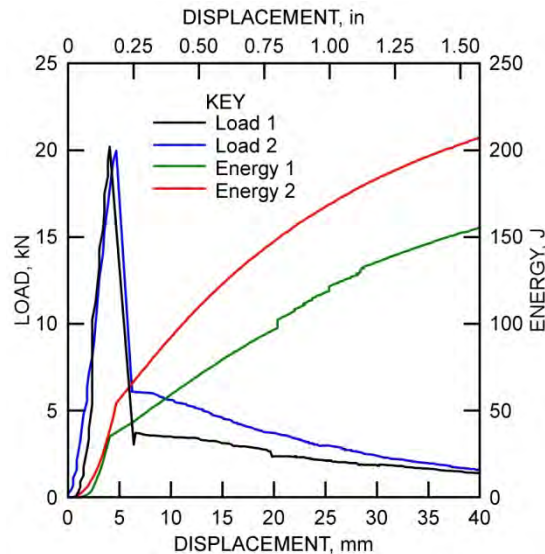

Figure 102. Comparison of load versus displacement and energy versus displacement curves for 1.87-kg/m^3 (3.15-lb/yd^3) Performax fiber mix with 28-day cure time.

Comparison of Shotcrete Support Systems Based on RDP Tests

A summary of the test results are presented in Table 14. There is a wide range of peak flexural loads and energies for shotcrete. The highest energy capacities are achieved with the welded wire mesh.

Table 14. Average results from field tests with round-panel shotcrete samples

a. Wet-mix shotcrete for the Pogo and Kensington mines

Sample	Mix type	Cement content, kg/tonne (lb/ton)	Cure time, days	Brand of fiber	Peak flexural load, kN (lbf)	Residual load capacity, kN (lbf)*
P2	Wet	325 (650)	1	Forta	1.7 (382.2)	0.25 (56.2)
K1	Wet	350 (700)	1	Forta	9 (2,023.3)	2 (449.6)

*Residual load capacity determined at 40 mm (1.6 in) of displacement

b. Dry mix shotcrete at Rockwell Mine

Sample	Mix type	Source of mix water	Slump, mm (in)	Cure time, days	Type of mesh	Peak flexural load, kN (lbf)	Residual load capacity, kN (lbf)*
SCACR-1	Dry	Well	nm [†]	28	none	8 (1,798.5)	nm
SCACR-2	Dry	Mine	127 (5)	28	none	15 (3,372.1)	nm
SCACR-3	Dry	Well	127 (5)	28	Wire mesh	16 (3,596.9)	11 (2,472.9)

*Residual load capacity determined at 35 mm (1.4 in) of displacement

[†]nm = not measured

c. Wet mix shotcrete reinforced with synthetic macro fiber at Devil's Slide Tunnels Project

Sample	Mix type	Slump, mm (in)	Cure time, days	Brand of fiber	Average energy, Joules*	Peak flexural load, kN (lbf)	Residual load capacity, kN (lbf) [†]
Kiewit-1	Wet	38 (1.5)	7	Shogun	400	25 (5,620.2)	4 (899.2)

*RDPT energy determined at 35 mm (1.4 in) of displacement

[†]Residual load capacity determined at 40 mm (1.6 in) of displacement

d. Wet mix shotcrete reinforced with synthetic macro fiber at Leeville Mine

Sample	Mix type	Slump, mm (in)	Cure time, days	Brand of fiber	Fiber content, kg/m ³ (lb/yd ³)	Average energy, Joules*	Peak flexural load, kN (lbf)	Residual load capacity, kN (lbf) [†]
LF-1	Wet	171 (6.75)	28	Shogun	1.87 (3.15)	160	18 (4,046.6)	2 (449.6)
LF-2	Wet	165 (6.5)	28	Shogun	2.99 (5.0)	276	21 (4,721.0)	5 (1,124.0)
LF-3	Wet	140 (5.5)	28	Shogun	4.12 (7.0)	302	23 (5,170.6)	6 (1,348.9)
LF-4	Wet	159 (6.25)	28	Performax	1.87 (3.15)	175	20 (4,496.2)	2 (449.6)

*RDPT energy determined at 40 mm (1.6 in) of displacement

[†]Residual load capacity determined at 40 mm (1.6 in) of displacement

e. Wet mix shotcrete reinforced with wire mesh at Leeville Mine

Sample	Mix type	Slump, mm (in)	Cure time, days	Type of wire mesh	Water reducer, kg/m ³ (lb/yd ³)	Average energy, Joules*	Peak flexural load, kN (lbf)	Residual load capacity, kN (lbf) [†]
LM-1	Wet	171 (6.75)	28	6 gauge	None	500	23 (5,170.6)	8 (1,798.5)
LM-2	Wet	127 (5.0)	28	6 gauge	1.6 (2.7)	710	22 (4,945.8)	11 (2,472.9)

*RDPT energy determined at 40 mm (1.6 in) of displacement

[†]Residual load capacity determined at 40 mm (1.6 in) of displacement

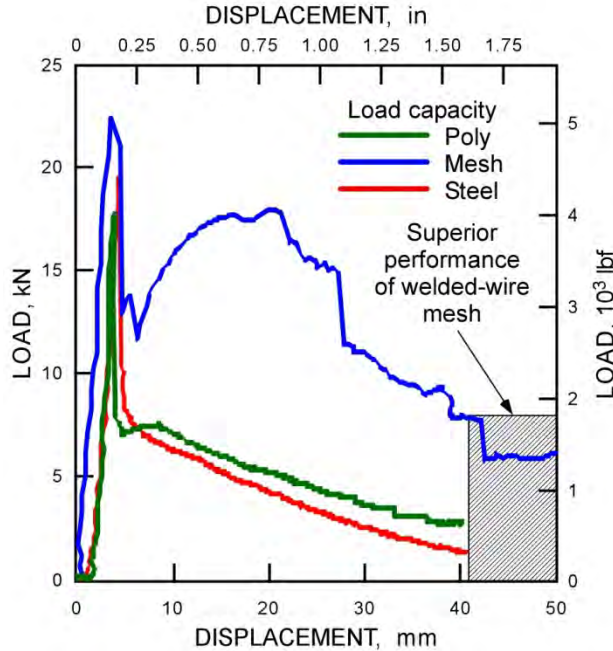

Figure 103. Comparison of load versus displacement curves for round-panel shotcrete samples reinforced with synthetic macro fiber (polyfiber), steel fiber, or wire mesh.

A comparison of the load displacement for selected panels reinforced with welded wire mesh or fibers (polyester and steel) is shown in Figure 103. For the panels reinforced with welded wire mesh, a six-gauge wire mesh was used with a spacing of 100 x 100 mm (4 x 4 in). For the shotcrete panels reinforced with polyfiber, a fiber dosage of 4.15 kg/m³ (7.0 lb/yd³) was used. The shotcrete panels reinforced with steel fiber were cast and tested at SRL in Spokane, Washington with a steel fiber dosage of 44.5 kg/m³ (75.1 lb/yd³). Both the steel and polyfiber dosages are typically recommended for shotcrete used in underground mines operating in weak ground conditions.

Peak flexural loads occur at displacements less than 6.3 mm (0.25 in). With the welded wire mesh, the peak flexural and residual loads are significantly higher than for either of the panels with fiber (Figure 103). The first-break load for the wire mesh is about 23 kN (5,170.6 lbf) as compared to 19 kN (4,271.4 lbf) for steel fiber and 17 kN (3,821.8 lbf) for polyfiber reinforcement.

At 40 mm (1.6 in), the welded wire mesh panel had a residual load of about 6 kN (1,348.9 lbf), though this load could only be maintained up to 12 mm (0.5 in) of displacement with the fiber reinforcement. The wire mesh curve shows that it has substantially greater post-peak, load-carrying capabilities even beyond the 40-mm (1.6-in) test standard. For use in a high displacement environment between 40–50 mm (1.6–1.9 in), the welded wire mesh panel can still carry a residual load much larger than that of the fiber reinforcement.

The energy capacity or toughness for each of the panels is also shown in Figure 104. The welded wire has a superior energy capacity or toughness not only at 40 mm (1.6 in), but up to 50 mm (1.9 in) as well. This implies that shotcrete with welded wire mesh will resist crack growth and have a much higher residual load for a given displacement than fiber-reinforced shotcrete.

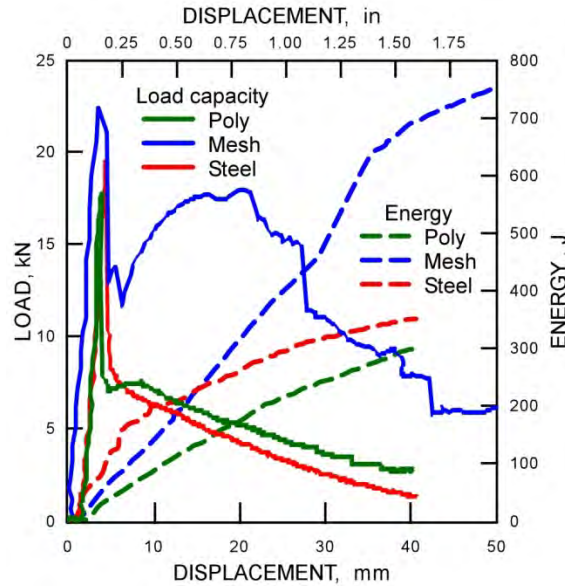

Figure 104. Comparison of load versus displacement and energy versus displacement curves for round-panel shotcrete samples reinforced with synthetic macro fiber (polyfiber), steel fiber, or wire mesh.

Design Requirements of Shotcrete as a Component of Support System Based on RDP Tests

Shotcrete is one of the support components in a multi-element ground support system that is typically used in weak rock conditions. Because shotcrete is applied in combination with a number of primary and secondary ground control devices (long and short bolts, mesh, strapping, etc.) the actual support provided by the shotcrete is difficult to determine. Because the support provided by the shotcrete is not well defined, analytical approaches for the design of shotcrete have not been developed. Instead, empirical designs based on type of ground (RMR or Q), span of the underground entry, and rock bolt spacing are commonly used, particularly for weak rock conditions.

Empirical Systems

Following are examples of some commonly used empirical systems that are currently available:

- The Q Classification System from Grimstad et al. [1993]
- The Rock Mass Rating (RMR) system from Bieniawski [1973]
- The New Austrian Tunneling Method [NATM 1962]

Both the Q and RMR classification systems are based on a rating of the following three principal properties of a rock mass:

- Intact rock strength
- Discontinuities and their strength properties
- Geometry of intact block of rock defined by the discontinuities

Characteristics of Empirical Systems

The main advantage of the Q classification system over the RMR system is that it is able to account for minor variations in rock properties. The disadvantage is that more knowledge and experience are required to use the Q system. The definitions used to describe joint conditions are complicated making the system difficult for inexperienced users to use in mines [Milne et al. 1998]. In actual application, the rock mass characterization systems are usually paired, analyzed simultaneously, and the results compared in order to give proper consideration to any parameters that one system might not include [Pakalnis 2008; Papworth 2002; Morgan et al. 1999; Bernard 2002; Grant 2001 et al.; Hoek et al. 2005; Barton et al. 1974].

The empirical systems have continued to evolve over time as new data becomes available and added to the existing characterization systems. Barton et al. [1974] originally developed a tunnel quality index (Q system) based on a rating of the principle properties of a rock mass for the Norwegian Geotechnical Institute. Grimstad and Barton [1993] then combined this Q rating with a number of geomechanical properties to produce a composite chart that provides guidance on the appropriate level of support required for the ground conditions.

Grimstad and Barton [1993] updated the chart adding fiber-reinforced shotcrete support systems. Papworth [2002] and Morgan et al. [1990] used a 10-m (30-ft) span opening to further refine the chart by adding recommendations on shotcrete thickness (in conjunction with rock bolts or steel sets) for different RMR values that had been developed by Bieniawski [1973], and a toughness correlation that had been developed by Grant et al. [2001]. However, the shotcrete with welded wire mesh was not included in the chart. Based on the round panel tests conducted in this study, the shotcrete reinforced with welded wire mesh that is used in the weak rock conditions of Nevada can now be incorporated into the design chart. Depending on the shotcrete design, the energy capacity or toughness of the shotcrete reinforced with the six-gauge welded wire mesh ranged from 500 to 700 joules at 40 mm (1.6 in) of displacement.

Empirical Design Chart

The composite chart developed through these efforts including the results of the testing on the panels with shotcrete reinforced with welded wire mesh, shown as “WM” in the reinforcement categories, is shown in Figure 105. Shotcrete reinforced with welded wire mesh is used in very poor to extremely poor rock where support systems with 400 joules of energy capacity or higher are recommended.

The chart in Figure 105 can be used as a guide for underground support system design by first assessing the rock mass quality, Q. This value is then applied along the x-axis of the chart. An estimate of the opening size (span or height) is made based on the ground conditions. The opening duration or excavation support ratio (ESR) value is used to indicate the time an excavation is expected to remain open in the mining cycle. In underground gold mines in Nevada, production stopes usually remain open for 3 to 5 days, and then they are backfilled. In other cases, such as an access or haulage way, the mine opening will have a long-term design life. Based on the geologic structure, an estimate of the span opening and duration can be made. The span or height is divided by the duration or ESR to obtain a value, which is then applied to the y-axis of the chart. The intercept of these x and y values on the chart yields the reinforcement category or level of support required for the ground conditions. The reinforcement categories, listed below the chart and illustrated between the dark bands on the chart, are used to identify the components and characteristics of the support system, including bolt length, bolt spacing, reinforcement, shotcrete

thickness, and shotcrete support capacity in terms of energy. The region of the chart highlighted with a red box most closely resembles the types of rock mass, rock mass ground conditions, support requirements, and type of ground support incorporating shotcrete that is used in weak rock mass mines (low RMR ground conditions). This is the intended subject of this document. Using this empirical design approach, the required length and spacing of the rock bolts can be determined, and the recommended energy of the shotcrete can be identified. These ground support criteria can then be used to establish an applicable testing and quality control program.

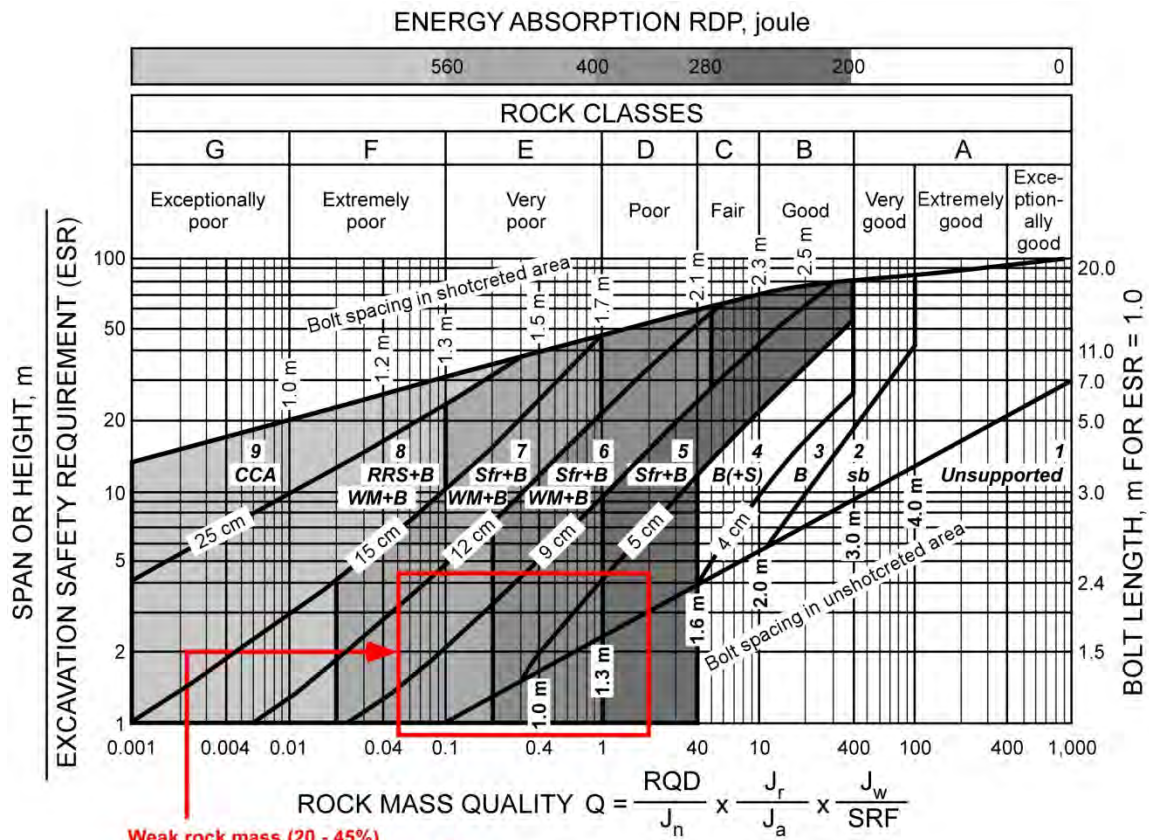

- Reinforcement categories
- | | |
|--|---|
| <ul style="list-style-type: none"> 1 Unsupported 2 Spot bolting, sb 3 Systematic bolting, B 4 Systematic bolting and unreinforced shotcrete, 4-10 cm, B(+S) | <ul style="list-style-type: none"> 5 Fiber reinforced shotcrete and bolting, 5-9 cm, Sfr+B 6 Welded wire mesh, fiber reinforced shotcrete and bolting, 9-12 cm, WM+B, Sfr+B 7 Welded wire mesh, fiber reinforced shotcrete and bolting, 12-15 cm, WM+B, Sfr+B 8 Welded wire mesh, fiber reinforced shotcrete > 15 cm and reinforced ribs of shotcrete and bolting, WM+B, Sfr+RRS+B 9 Cast concrete lining, CCA |
|--|---|

Excavation categories	ESR
A Temporary mine openings	3-5
B Permanent mine openings, water tunnels for hydro power (excluding high pressure penstocks), pilot tunnels, drifts and headings for large excavations	1.6
C Storage rooms, water treatment plants, minor road and railway tunnels, surge chambers, access tunnels	1.3
D Power stations, major road and railway tunnels, civil defense chambers, portal intersections	1.0
E Underground nuclear power stations, railway stations, sports and public facilities, factories	0.8

Figure 105. Estimated support categories based on tunneling quality index Q, after Grimstad et al. [1993], Papworth [2002], Pakalnis [2010], and modified by NIOSH.

Empirical Design Table

Hoek et al. [2005] produced a compilation of current shotcrete practices, combining many of these empirical guidelines along with their practical experience. The information presented in Table 15 is a summary of the types of rock mass, rock mass ground conditions, support requirements, and type of support incorporating shotcrete to use in low RMR or weak rock conditions. This table can only be used as an approximate guide when deciding upon the type and thickness of shotcrete to be applied in a specific application. Modifications will almost certainly be required to deal with local variations in rock conditions and shotcrete quality.

Table 15. Summary of shotcrete applications in underground mining for different rock mass conditions, after Hoek et al. [2005]

Rock mass description	Rock mass behavior	Support requirements	Shotcrete application
Highly jointed and bedded weak sedimentary rock.	Surface slabbing, spalling, and potential for wedges or blocks to fall or slide due to bedding plane exposures.	Provision of support in addition to that available from rock bolts or cables. Sealing of weak bedding plane exposures.	Apply 75 mm (3 in) of shotcrete on rock, install rock bolts with faceplates over wire mesh to springline, and then apply a second 25-mm (1-in) layer of shotcrete. Install a second round of longer rock bolts with faceplates in mine back.
Metamorphic or igneous rock with shear zone planes, joints, or faults with gouge.	Raveling of small rock wedges and blocks defined by intersecting joints along with squeezing and 'plastic' flow of rock mass opening.	Prevention of progressive raveling, retention of broken rock, control of rock mass dilation, and control of squeezing.	Rock bolts or dowels are required to control bed separation. Apply 75 mm (3 in) of plain shotcrete over welded wire mesh anchored behind bolt faceplates or apply 75 mm (3 in) of steel-fiber-reinforced shotcrete on rock. Extend shotcrete application down sidewalls where required. Install rock bolts with faceplates and then apply a second 25-mm (1-in) layer of shotcrete. Install second round of longer rock bolts with faceplates in mine back. Thicker shotcrete layers may be required at high stress concentrations.

Table 16 (continued). Summary of shotcrete applications in underground mining for different rock mass conditions, after Hoek et al. [2005]

Rock mass description	Rock mass behavior	Support requirements	Shotcrete application
Heavily jointed sedimentary rock with clay coated surfaces with metamorphic intrusion.	Bed separation in wide-span excavations with potential for wedges or blocks to fall or slide and raveling of bedding in inclined hanging and footwalls.	Control of rock mass failure and dilation along with retention of broken rock and control of propagation in addition, sealing of weak bedding plane exposures.	Apply 50-mm (2-in) shotcrete over welded wire mesh anchored behind bolt faceplates, or apply 50 mm (2 mm) of steel-fiber-reinforced shotcrete on rock and install rock bolts with faceplates. Extend shotcrete application down sidewalls where required. Install second round longer rock bolts with faceplates in mine back apply a second 25 to 50-mm (1 to 2-in) layer of shotcrete. Install rebar or cable lacing where applicable and then apply another 25 to 50-mm (1 to 2-in) layer of shotcrete in critical areas. This develops 125 to 150 mm (5 to 6 in) of shotcrete over mesh or cable lacing that is firmly attached to the rock surface by means of rock bolts or cable bolts.

Quality Control Testing in the Field

The objective of quality control testing is to ensure that the shotcrete meets design requirements. The tests and methods used should be reliable and timely, simple to perform, and relatively inexpensive. The type of information gathered from testing should provide an assurance of design compliance or identify a discrepancy that leads to a specific course of corrective action. As discussed in previous sections, the elements that make up the shotcrete process affect the quality of the final installed product and its ability to contribute to the entire support system. In addition, you must allow sufficient curing time following the application of the shotcrete before mining activities resume. Before underground mine workers are allowed access to recently sprayed entries, the shotcrete must gain enough strength to safely support the ground. Furthermore, the installation of rock bolts through freshly applied shotcrete can compromise the integrity of the shotcrete.

The focus of quality control testing in the context of this report are four main shotcrete design and installation compliance requirements that consist of early strength, bond strength, load-capacity, toughness, and thickness. Two of these tests, early strength and load capacity, are performed on samples of material collected just prior to application and allowed to cure. The remaining tests involve adhesion strength testing and installed thickness determination on in-situ cured shotcrete material. The quality testing presented in this section assumes that the shotcrete program at the particular mine location is at a point in development where suitably qualified professionals have determined a mix design, constituent materials, and shotcrete application equipment; have trained qualified personnel; and are ready to proceed with premining trials followed by ongoing performance tests with shotcrete during the mining cycle [Spearing 2001; Morgan 2008].

Premining-cycle Trials

Premining-cycle trials are used to validate the process and determine expected values and allowable variability for ongoing mining-cycle quality control design and installation compliance tests. Premining-cycle trials should be conducted using the same equipment, methods, and personnel that will be used for installing the shotcrete once the mining cycle starts. Test samples for early strength, flexural load capacity, and toughness should be collected, tested, and the results assessed in terms of the reliability and repeatability of the values obtained and the soundness of the methods. If the procedures and methods produce reliable values to the standards set by qualified professionals administering the quality control program, the performance of the mix design proposed for mine cycle use can then be used as a benchmark. At this point, the averaged results of early-strength testing of sprayed samples for the period of 1–6 hrs after spraying and that for the averaged results of round panel flexural and toughness testing should have been determined [AuSS 2008].

Mine Cycle Testing

The frequency of mining cycle testing of the shotcrete will depend on the severity of the support application demands and if the installed product is not performing up to the design requirements. There is also a timing element, whereas, the sooner a problem is detected, the sooner corrective action can be taken. The frequency of testing can be specified on the basis of volume of shotcrete applied, area of shotcrete sprayed, or per shift. An example of recommended frequencies for mining applications is shown in Table 16 [AuSS 2008].

Table 17. Recommended frequency of shotcrete tests for mining applications, after AuSS [2008]

Characteristic analyzed	Location	Test method	Minimum frequency
Shotcrete quality, thickness, tensile strength, and bond strength	In-stope after application	NIOSH Shotcrete Adhesion Test System	One hole for each 50 m ² (65 yd ²) or part thereof
Shotcrete early strength	From batched and sprayed shotcrete	ASTM C116	One set per week or per 250 m ³ (325 yd ³) or part thereof, whichever is more frequent
Shotcrete peak flexural load, residual load capacity, and energy or toughness	From batched and sprayed shotcrete	ASTM C1550	One set per week or per 250 m ³ (325 yd ³) or part thereof, whichever is more frequent

A well-designed shotcrete program requires a detailed and comprehensive quality-management plan that checks all aspects of the application process and takes effective, appropriate, and immediate action when a problem is identified. There are numerous examples in the literature of these kinds of well-defined plans and checklists. In the case of the tests described in the preceding

sections, the accurate documentation of the areas where shotcrete is applied each day that can then be indexed to test results is of particular importance because with this information the area where corrective action must be taken can be located. Should a situation arise where obvious operational, procedural, equipment, safety, or post-installation testing of cured samples reveals test values for the shotcrete performance that are not in compliance with the allowable limits, then a feasible and safe contingency action plan of specific corrective measures should be available [Spearing 2001]. An example of a simple corrective action plan that covers preshotcreting, during and shortly after shotcreting, and a period of time after shotcreting is shown in Table 17.

Table 18. Typical corrective actions for shotcrete problems

Time period	Characteristics	Comments
Preshotcreting	Mix composition, aggregate grading, cement, available material, storage conditions, equipment condition, services (power, water, lighting), and safety	Correct discrepancies in the preshotcreting phase prior to beginning the batch process.
During and after shotcreting	Substrate condition	Properly prepare substrate prior to applying shotcrete.
	Accelerator level	Do not apply shotcrete if it is too hot and beginning to flash.
	Early strength, visual assessment	Allow shotcrete to cure sufficiently to a self-supporting state before permitting entry.
	Early strength, partial-beam test sample	If the early strength of the test sample is inadequate, modify the mix, or allow longer cure time.
	Thickness	Apply more shotcrete, if thickness is less than design criteria.
	Rebound	Modify mix process or shotcrete spraying application to minimize rebound.
Days after shotcreting	Surface finish	Modify application technique to minimize variations in thickness and eliminate lensing.
	Curing	Modify accelerator or water-to-cement ratio, or allow longer curing time for strength gain.
Days after shotcreting	Test samples and in-place ground support	Monitor shotcrete process through testing and visual inspection, monitor ground stability, and install additional ground support (bolts and shotcrete) as needed.

Summary and Conclusions

NIOSH researchers successfully conducted tests onsite at mine sites, using the three portable test machines they developed, to determine shotcrete early strengths, adhesion strengths, and toughness on field-specified shotcrete mixes. With the ability to test shotcrete strength at the mine site or field location researchers and mine personnel are now able to analyze the data from the tests and make corrections immediately if needed; they no longer have to wait weeks for the data to be analyzed by an outside company. This type of testing and immediate analyzing of the data obtained from the tests can provide a safer workplace by informing mine personnel, in a timely manner, of the strength properties of the in-place ground control at the mine. All of the test systems introduced by NIOSH researchers were well-received at the locations where the tests were conducted; some locations even had machines commissioned to carry on the testing after the initial research was completed.

Field trials conducted with the portable shotcrete test machines have demonstrated that the test equipment can operate reliably in underground mine environments and that mine personnel can easily conduct the tests. These unique machines produce timely, meaningful, repeatable, and accurate test results that are consistent with the results obtained from fixed laboratory-based test equipment.

Early Strength, Partial-beam Compression Test

Safe re-entry time can be determined by conducting an early strength test to characterize and define the strength development of freshly sprayed shotcrete. Determining safe re-entry can improve mine safety by identifying an appropriate re-entry time for mine workers and machinery in the mining cycle. A field-expedient test method and portable onsite test equipment have been developed to measure shotcrete strength in the first six hours after application. Using this test method and equipment, underground mine personnel can measure the early compressive strength properties of as-placed shotcrete and clearly identify the shotcrete's early strength threshold in real time. This information allows more informed decisions to be made regarding safe re-entry times and can also improve mine safety by supplying pertinent site-specific shotcrete information. A typical shotcrete mix used for ground control would exhibit the development of a compressive strength of 1 MPa (145 psi) within 1 to 6 hours after placement when measured, using the partial-beam test standard, ASTM C 116 [1990]. Another safe re-entry definition is: the time shotcrete takes to develop enough strength to resist the normal ground pressure and allow drilling and the remaining support system elements to be installed without degradation of the shotcrete or its long-term strength gain characteristics [Iwaki et al. 2001, O'Toole and Pope 2006; Clements 2009]. NIOSH researchers conducted early strength tests on commercially available shotcrete for weak rock conditions and found that the majority of the samples reached 1 MPa (145 psi) after three hours, which corresponds to the findings of Morgan et al. [1995] and Clements [2004].

Overcoring and Direct-tension Pull Test

The installed quality of shotcrete in terms of thickness and adhesion are important indicators of the available load-carrying support of the shotcrete and its adherence to shotcrete application criteria. Mine safety can be improved by determining if the shotcrete application criteria have been followed and if any load-carrying support is available from the adhesion of the shotcrete to the underlying rock. Shotcrete bond strength adds to the load-carrying capability provided by the host rock over and above the system's intrinsic support (i.e. plated primary and secondary bolts). The direct-tension pull test provides a method for measuring the bond strength as well as evaluating the quality of the shotcrete application. Installed quality is assessed by comparing the observable core characteristics obtained during the pull test to known standards set forth in the quality monitoring program. Additionally, the host rock quality and strength can be directly compared to the shotcrete's strength and a determination made on whether the host rocks' geological structure is either physically stronger or weaker than the shotcrete. NIOSH researchers developed a wet core drilling method used to extract core samples, allowing for scrutiny of the core. Typical application quality indicators with regard to the wet core drilled sample that are examined and scrutinized include the applied thickness, the presence of voids and lenses, the presence of reinforcement, type and location and/or density of the reinforcement, underlying host rock quality, the relative bond to the host rock substrate, and relative failure location. Researchers conducted core inspections from direct tensile pull testing of as-placed shotcrete to characterize and define the quality and bond strength at multiple sites. Results from the tests conducted on sprayed test panels at NIOSH's Spokane facility indicate that the shotcrete's average adhesion strength increased markedly between one and three days of curing, from 0.44 to 1.13 MPa (64 to 164 psi).

Round Determinate Panel Test

This research has shown that the round determinate panel test (RDPT) of as-placed shotcrete to characterize and define the peak flexural load, the post-crack load-carrying capacity at a given displacement, and the toughness of a particular shotcrete mix can improve mine safety by allowing for a better understanding of the support provided by the shotcrete component. Residual load capacity and toughness are indicators of the effects of the reinforcement added to the shotcrete to increase strength after cracks have formed and represent the capacity of a welded wire mesh or fiber-reinforced shotcrete to carry load following cracking and therefore continue to offer structural support. When these values are known, the ground control system can then be compared to the anticipated mine opening support loads and displacements. Multiple series of round determinate panel tests were conducted using either synthetic polyfiber, welded wire mesh, or steel fiber. During the tests the specimens enter "peak crack strength" with the appearance and propagation of a determinate crack. After this phase of the test, the specimens are in the residual load-carrying capacity of the reinforcement placed in the panels; this in turn determines the total energy of the panels from the load over a given displacement, usually 40 mm (1.6 in). Peak load and displacements were measured on all tests along with energy where applicable. The flexural load capacity first break values for RDPT on the tested weak rock shotcrete mixes with reinforcement typically ranged from 20–35 kN (4,496.2–7,868.3 lbf) with a residual load capacity of 6 kN (1,348.9 lbf) at 40-mm (1.6-in) displacement and 280 Joules of energy or toughness, which is in agreement with high-displacement ground control as suggested

by AuSS [2008], Bernard [2002], and Papworth [2002]. Although test results with welded wire mesh provided some of the highest energy values during testing, it should be noted that the welded wire mesh was placed in the middle of the test panels. Panel strengths and energies with welded wire mesh are affected by the placement of the welded wire mesh. Typical alternative placement locations are either in the top or bottom layer of the panel, and testing has shown that these welded wire mesh locations produce different load and energy values. Therefore, placement location of the welded wire mesh should match the in-mine construction to properly determine the welded wire mesh test panel loads and energies for a particular mine.

Summary of Discussion

By using NIOSH-developed portable, mine-site shotcrete testing machines, mine personnel can measure early compressive strength development, bond strength, and flexural load capacity. Establishing and monitoring these strength characteristics can improve safety by insuring that the shotcrete used within the ground support system meets the ground support design specifications as shown in this study.

Field trials conducted with the portable shotcrete test machines have demonstrated that the test equipment can operate reliably in underground mine environments and that mine personnel can easily conduct the tests. These unique machines produce timely, meaningful, repeatable, and accurate test results that are consistent with the results obtained from fixed laboratory-based test equipment.

Furthermore, an empirical design chart can be used to assist in determining the appropriate design requirements for shotcrete in weak rock mass conditions. This design chart was modified based on the results from NIOSH tests conducted with shotcrete round panels with and without welded wire mesh and observed ground control practices in U.S. underground mines.

Acknowledgements

The authors thank James Schumacher and Paul Meyer with Thiessen Team USA, Elko, Nevada; Vince Mendive with Thiessen Team USA, Big Timber, Montana; and Mark Mudlin with BASF, Master Builders, Elko, Nevada, for their technical support regarding commercial shotcrete mixes and application practices. We also thank Justin Deemer and Rocky Wegland with Westech Automation in Spokane, Washington, for their assistance developing the testing machines. In addition, we thank Louis Sandbak and Rory Upshaw, Barrick Gold Corporation, Turquoise Ridge Joint Venture, Golconda, Nevada; Dr. Changshou Sun and Bob Riley, Newmont Mining Corporation, Leeville Mine, Carlin, Nevada; and Dr. Jeramy Decker, Kiewit Corporation, Devil's Slide Tunnels Project, Pacifica, California for their cooperation and assistance conducting shotcrete tests on site. We especially thank Dr. Rimas Pakalnis, Pakalnis and Associates, Vancouver, B.C., Canada, for his guidance and collaboration in this research.

References

- ACI 506R-05 [2005]. Guide to shotcrete. American Concrete Institute, ACI Committee 506R-05.
- ACI 506.1R-98 [1998]. Committee report on fiber reinforced shotcrete. American Concrete Institute, ACI Committee 506.1R-98.
- ASTM C1117 [1989]. Standard test method of time of setting of shotcrete mixtures by penetration resistance. West Conshohocken, PA: American Society for Testing and Materials, (Withdrawn 2003).
- ASTM C116 [1990]. Standard test method for compressive strength of concrete using portions of beam broken in flexure. West Conshohocken, PA: American Society for Testing and Materials (Withdrawn 1999).
- ASTM C403 [1999]. Standard test method of time of setting of concrete mixtures by penetration resistance. West Conshohocken, PA: American Society for Testing and Materials.
- ASTM C1140 [2003]. Standard practice for preparing and testing specimens from shotcrete test panels. West Conshohocken, PA: American Society for Testing and Materials.
- ASTM C1583/C1583M [2004]. Standard test method for tensile strength of concrete surfaces and the bond strength or tensile strength of concrete repair and overlay materials by direct tension (pull-off method). West Conshohocken, PA: American Society for Testing and Materials.
- ASTM C1604/C1604M [2005]. Standard test method for obtaining and testing drilled cores of shotcrete. West Conshohocken, PA American Society for Testing and Materials.
- ASTM C136 [2006]. Standard test method for sieve analysis of fine and coarse aggregates. West Conshohocken, PA: American Society for Testing and Materials.
- ASTM C143/C143M [2010]. Standard test method for slump of hydraulic-cement concrete. West Conshohocken, PA: American Society for Testing and Materials.
- ASTM C1550 [2010]. Flexural toughness of fiber-reinforced concrete (using centrally loaded round panel). West Conshohocken, PA: American Society for Testing and Materials.
- ASTM C1609/C1609M [2010]. Standard test method for flexural performance of fiber-reinforced concrete (using beam with third-point loading). West Conshohocken, PA.
- ASTM C39/C39M [2011]. Standard test method for compressive strength of cylindrical concrete specimens. West Conshohocken, PA: American Society for Testing and Materials.
- AuSS [2008]. Shotcreting in Australia: recommended practice. Sydney: Australian Shotcrete Society (AuSS) and Concrete Institute of Australia.
- Barrett SVL, McCreath DR [1995]. Shotcrete support design in blocky ground: towards a deterministic approach. *Tunn Undergr Space Tech* 10(1):79–89.
- Barton N, Bandis SC [1990]. Review of predictive capabilities of JRC-JCS model in engineering practice. Proceedings of the International Symposium on Rock Joints, Loen, Norway, pp. 603–610.

- Barton N, Lien R, Lunde J [1974]. Engineering classification of rock masses for the design of tunnel support. *Rock Mech Rock Eng* by Springer-Verlag pp. 189–236.
- Bauer G, Donaldson D [1992]. Perimeter control in development and breasting by use of a blasting program readily accepted by miners. *Proceedings of the 18th Annual Conference on Explosives and Blasting Technique*. Cleveland, Ohio: International Society of Explosives Engineers, pp. 133–140.
- Bernard ES [2002]. Correlations in the behavior of fibre reinforced shotcrete beam and panel specimens. *Mater Struct, RILEM*, 35(35):156–164.
- Bernard ES [2006]. The influence of toughness on the apparent cracking load capacity of fiber-reinforced concrete slabs. *J Struct Eng, ASCE Library*, 132(12):1976–1983.
- Bernard ES [2008]. Early-age load resistance of fibre reinforced shotcrete linings. *Tunn Undergr Sp Tech* 23:(4) 451–460.
- Bieniawski ZT [1973]. Engineering classification of jointed rock masses. In *transactions of the South African Institution of Civil Eng* 15, pp. 335–344.
- Brennan E [2005]. Testing shotcrete for bond. *American Shotcrete Association, Shotcrete Magazine*, Winter, pp. 18–19.
- Clark CC, Stepan MA, Seymour JB, Martin LA [2011]. Early strength performance of modern weak rock mass shotcrete mixes. *Society for Mining, Metallurgy, and Exploration, Mining Engineering*, January 2011, Vol. 63, No. 1, pp. 54–59.
- Clements M [2004]. Comparison of methods for early age strength testing of shotcrete. *Shotcrete: more engineering developments*. In: Bernard E, ed. *Proceedings of the 2nd International Conference on Engineering Developments in Shotcrete*, Cairns, Queensland, Australia. London: Taylor and Francis Group, pp. 81–87.
- Clements M [2009]. Exploring the limits of shotcrete loading capacity at early age. Website of Grenz Consulting Pty Ltd., <http://www.grenz.com.au/>
- Clements MJK, Jenkins PA, Malmgren L [2004]. Hydro-scaling – an overview of a young technology. *Shotcrete: more engineering developments*. In: Bernard ES, ed. *Proceedings of the 2nd International Conference on Engineering Developments in Shotcrete*, Cairns, Queensland, Australia. London: Taylor and Francis Group, pp. 89–96.
- Decker JB, Madsen PH, Gall V [2010]. ARMA 10-402, Examination of shotcrete liner at Devil's Slide Tunnel utilizing ASTM 1550 field test results and back analysis. *Proceedings of the 44th U.S. Rock Mechanics Symposium and 5th U.S.-Canada Rock Mechanics Symposium*, June 27–30, 2010, Salt Lake City, UT: American Rock Mechanics Association.
- Grant NB, Ratcliffe R, Papworth F [2001]. Design guidelines for the use of SFERS in ground support. *Shotcrete: engineering developments*. Bernard ES, ed. Swets & Zeitlinger, Lisse, ISBN 905809.1767, pp. 111–118.
- Grimstad E, Barton N [1993]. Updating the Q-system for NMT. In: Kompen, Opsahl, Berg, eds. *Proceedings of the International Symposium on Sprayed Concrete - Modern Use of Wet Mix Sprayed Concrete for Underground Support*, Fagernes. Oslo: Norwegian Concrete Association.

- Hahn T, Holmgren J [1979]. Adhesion of shotcrete to various types of rock surfaces and its influence on the strengthening function of shotcrete when applied on hard jointed rock. In: Proceedings of the 10th International Congress on Rock Mechanics. Montreux, Switzerland, pp. 431–439.
- Heere R, Morgan D, McAskill N [2002]. Determination of early-age compressive strength of shotcrete. American Shotcrete Association, Shotcrete Magazine, Spring, pp. 28–31. Based on paper from Shotcrete: A Compilation of Papers, pp. 23–32, originally published by Norwegian Concrete Association, in the 3rd International Symposium on Sprayed Concrete, Gol, Norway.
- Hoek E, Kaiser PK, Bawden WF [2005]. Support of underground excavations in hard rock. New York, NY: Taylor & Francis.
- Holmgren J [2001]. Shotcrete linings in hard rock. In: Hustrulid WA, Bullock RL, eds. Underground Mining Methods, Engineering Fundamentals and International Case Studies. SME, USA, Chapter 66, pp. 569–577.
- Iwaki K, Hiram A, Mitani K, Kaise S, Nakagawa K [2001]. A quality control method for shotcrete strength by pneumatic pin penetration test. NDT & E International 34(6):395–402.
- Jolin M, Beaupre D, Mindess S [1999]. Tests to characterize properties of fresh dry-mix shotcrete. Cem Concr Res 29:753–760.
- Kaiser PK, Tannant DD [2001]. The role of shotcrete in hard-rock mines. In: Hustrulid WA, Bullock RL, eds. Underground Mining Methods: Engineering Fundamentals and International Case Studies, SME, USA, Chapter 67, pp. 579–592.
- Knight B, Rispin M, Clegg I [2006]. Wet-mix shotcrete as a material, process, and ground control component of a 21st century underground mining operation. Shotcrete for Underground Support X, (SUS-X). In: Morgan D, Parker H, eds. Proceedings of the 10th International Conference on Shotcrete for Underground Support, September 12–16, 2006. Whistler, BC, Canada: American Society of Civil Engineers, pp. 298–306.
- Kuchta M [2003]. Shotcrete adhesion tests at NIOSH's Lake Lynn Laboratory (TR4-2). Project Report.
- Kuchta ME [2002]. Quantifying the increase in adhesion strength of shotcrete applied to surfaces treated with high-pressure water. Presented at the 2002 Annual Meeting and Exhibit, Society for Mining, Metallurgy, and Exploration, Feb 25–27, 2002, Phoenix, AZ, SME Preprint 02-35, 4 pp.
- Mahar JW, Parker HW, Wuellner WW [1975]. Shotcrete practice in underground construction. Federal Railroad Administration, U.S. Department of Transportation Report No. FRA-OR&D, pp. 75–90, National Technical Information Service, Springfield, VA.
- Malmgren L, Nordlund E, Rolund S [2005]. Adhesion strength and shrinkage of shotcrete. Tunn Undergr Sp Tech 20(1): 33–48.
- Malmgren L, Svensson T [1999]. Investigation of important parameters for unreinforced shotcrete as rock support in the Kiirunavaara Mine, Sweden. In: Amadei B, Kranz RL, Scott GA, and Smeallie PH, eds. Proceedings of the 37th US Rock Mechanics Symposium, Vail, CO, June 6–9, AA Balkema, Rotterdam, pp. 629–635.

- Martin L, Dunford J, MacLaughlin M, Cronoble R [2007]. Tests of fiber-reinforced shotcrete at the Chief Joseph Mine, Butte, Montana. Society for Mining, Metallurgy, and Exploration, 2007 Transactions Vol. 322, pp. 61–64.
- Martin L, Seymour B, Clark C, Stepan M, Pakalnis R, Roworth M, Caceres C [2011]. An analysis of flexural strength and crack width for fiber-reinforced shotcrete used in weak rock mass mines. Society for Mining, Metallurgy, and Exploration, 2010 Transactions Vol. 328, pp. 542–549.
- Martin LM, Seymour JB, Clark CC, Pakalnis R, Stepan MA [2010]. An analysis of fiber-reinforced round panel strengths and comparison to wire mesh bag strength. Presented at the 2010 Annual Meeting and Exhibit, Society for Mining, Metallurgy, and Exploration, Feb 27–Mar 4, 2010, Phoenix, AZ, SME Preprint No. 10-140, 6 pp.
- Melbye T [2001]. Sprayed concrete for rock support. 9th ed. MBT International, Underground Construction Group, Division of MBT, pp. 186–193.
- Milne D, Hadjigeorgiou J, Pakalnis R [1998]. Rock mass characterization for underground hard rock mines. *Canadian Tunneling* 13(4): 391–393.
- Morgan D [2008]. Steel fiber reinforced shotcrete for support of underground openings in Canada. *Shotcrete: A Compilation of Papers, American Shotcrete Association* pp. 203–211. Originally published by American Concrete Institute, *Concrete Int* 13(11): 56–64.
- Morgan D, McAskill N, Heere R [1999]. Determination of early-age compressive strength of shotcrete. Presented at the Third International Symposium on Sprayed Concrete in Gol, Norway, Sept. 1999.
- Morgan DR, Chen L, Beaupré D [1995]. Toughness of fibre reinforced shotcrete. In: Klapperich H, Pottler R, Willocq, eds. *Proceedings of the Engineering Foundation Conference, Shotcrete for Underground Support VII. Vol. 2. Telfs, Austria: American Society of Civil Engineers*, pp. 66–87.
- Morton E, Thompson A, Villaescusa E [2008]. Static testing of shotcrete and membranes for mining applications. *Proceedings of the 6th International Symposium on Ground Support. Cape Town, Johannesburg: South African Institute of Mining and Metallurgy*, pp. 195–212.
- NATM [1962]. *New Austrian Tunnelling Method*. Ladislaus von Rabcewicz, Leopold Müller and Franz Pacher.
- NCA [2007]. *Sprayed concrete for rock support – technical specifications, guidelines and test methods*. Norwegian Concrete Association. Publication Number 7.
- Neville AM [2009]. *Properties of concrete*. 4th ed. Harlow, England: Prentice Hall/Pearson Education.
- Nordström E, Grändås J [2005]. Effective in-place testing of bond strength with Swedish friction grip. *American Shotcrete Association, Shotcrete Magazine, Summer*, pp. 18–19.
- O’Toole D, Pope S [2006]. Design, testing, and implementation of “in-cycle” shotcrete in the northern 3500 orebody. *Shotcrete for Underground Support X, (SUS-X)*. In: Morgan D and Parker H, eds. *Proceedings of the 10th International Conference*. Whistler, BC, Canada: American Society of Civil Engineers, pp. 316–327.

- Pakalnis R [2008]. Methodology towards ground support, strategic vs. tactical approaches in mining. Canadian Institute of Mining Conference 2008, Laval University, Quebec City, Quebec.
- Pakalnis R [2010]. Design of underground mine openings utilizing shotcrete. Kencana Mine Presentation, Spokane Research Laboratory, Apr 8–9.
- Papworth F [2002]. Design guidelines for use of fiber reinforced shotcrete in ground support. American Shotcrete Association, Shotcrete Magazine, Spring, pp. 16–21.
- Rispin M [2005]. Reentry into a shotcreted, underground heading. American Shotcrete Association, Shotcrete Magazine, Spring, pp. 26–30.
- Rispin M, Knight B, Dimmock R [2003]. Early re-entry into working faces in mines through modern shotcrete technology – Part II. Canadian Institute of Mining, Mines Operations Centre (CIM-MOC), Saskatoon, SK, Canada.
- Rose D [1985]. Steel-fibre-reinforced shotcrete for tunnel linings: the state of the art. Proc. 1985 Rapid Excavation and Tunneling Conference, Society for Mining, Metallurgy, and Exploration, Vol. 1, pp. 392–412.
- Saiang D, Malmgren L, Nordlund E [2005]. Laboratory tests on shotcrete–rock joints in direct shear, tension and compression. *Rock Mech Rock Eng* 38(4):275–297.
- Seymour B, Martin L, Clark C, Stepan M, Jacksha R, Pakalnis R, Roworth M, Caceres C [2011]. A shotcrete adhesion test system for mining applications. Society for Mining, Metallurgy, and Exploration, 2010 Transactions Vol. 328, pp. 533–541.
- Seymour JB, Martin LA, Clark CC, Tesarik DR, Stepan MA [2013]. An analysis of recent MSHA accident data for underground metal mines using backfill. Presented at the 2013 Annual Meeting and Exhibit, Society of Mining, Metallurgy, and Exploration, Feb 24–27, 2013, Denver, CO, SME Preprint No. 13-061, 9 pp.
- Spearing S [2001]. Shotcrete as an underground support material. In: Hustrulid WA, Bullock R, eds. *Underground Mining Methods: Engineering Fundamentals and International Case Studies*, SME, Littleton, Colorado, USA, Chapter 65, pp. 563–568.
- SRSUM [1999]. Code of practice. *Surface Rock Support for Underground Mines (SRSUM)*. Mines Occupational Safety and Health Advisory Board, Western Australia, February.
- Thomas A [2009]. *Sprayed concrete lined tunnels*. New York, NY: Taylor & Francis.
- Vandewalle M. [1993]. *Dramix: Tunnelling the world*. 3rd ed. Zwevegem, Belgium: N.V. Bekaert S.A.
- Wood DF [1992]. Specification and application of fibre reinforced shotcrete. In: Kaiser PK, McCreath DR, eds. *Rock Support in Mining and Underground Construction*. Proceedings of the International Symposium on Rock Support. Sudbury, Ontario, Canada. Rotterdam, Netherlands: A. A. Balkema, pp. 149–156.

Appendix

Equipment Specifications for Portable Shotcrete Test Machines

Table A1. Early strength test machine

a. Press specifications

Capacity	2,268 kg (5,000 lb)
Height	70 cm (27.5 in)
Width	30.5 cm (12 in)
Depth	25.5 cm (10 in)
Speed, test	1.27 mm/min (0.50 in/min)
Speed, jog	91.4 mm/min (3.6 in/min)
Drive system	Ball screw
Control	AutomationDirect closed loop servo
Height	36 cm (14.25 in)
Width	17 cm (6.95 in)
Depth	35.5 cm (14 in)
Power	110 VAC
Operating system	Eaton controls
Data system	Eaton controls
Output	± 0–5 Volt signal

b. Control box specifications

Height	36 cm (14.25 in)
Width	17 cm (6.95 in)
Depth	35.5 cm (14 in)
Power	110 VAC
Operating system	Eaton controls
Data system	Eaton controls
Output	± 0–5 Volt signal

Table A2. RDP test machine**a. Press specifications**

Capacity	10,886 kg (24,000 lb)
Height	185 cm (73 in)
Width	150 cm (59 in)
Depth	84 cm (33 in)
Speed, test	4.0 mm/min (0.16 in/min)
Speed, jog	45.7 mm/min (1.8 in/min)
Drive system	Ball screw
Control	AutomationDirect closed loop servo

b. Control box specifications

Height	41 cm (16 in)
Width	23 cm (9 in)
Depth	41 cm (16 in)
Power	110 VAC
Operating system	Eaton controls
Data system	Eaton controls
Output	± 0–5 Volt signal

Table A3. Overcoring and direct-tension test system**a. Drilling unit specifications**

Component	Specification
Drill	Hilti DD-130 core drill (wet/dry)
Drive system	Three-speed forward and reverse
Drill stand	Hilti DD-ST-130, 11-in width x 22-in depth x 43-in height
Diamond core bit, test core	Hilti DD-BI, 4-in OD* x 17-in length
Diamond core bit, kerf	Hilti DD-BI, 5-in OD x 17-in length
Drill bit, pulling stud	Hilti TE-C3X, $\frac{7}{16}$ -in OD x 6-in length
Custom drill chuck	Hilti DD-BI drill bit chuck welded to Bosch spline to SDS adaptor

b. Pulling unit specifications

Component	Specification
Extension rod	Threaded rod, $\frac{3}{8}$ -16 UNC [†] x 30 in
	Hex coupling nut, $\frac{3}{8}$ -16 UNC x 1 $\frac{1}{8}$ in
	Hex nut, $\frac{3}{8}$ -16 UNC
	Step collet, $\frac{3}{8}$ -in ID [‡] x 1-in overall height with 1 $\frac{1}{4}$ -in OD x $\frac{3}{8}$ -in height and $\frac{3}{4}$ -in OD x $\frac{5}{8}$ -in height
	Locknut, slip-on quick-threading, $\frac{3}{8}$ -16 UNC
Pulling fixture, aluminum weldament	Aluminum tubing, 6-in OD x 6 $\frac{1}{2}$ -in height x $\frac{3}{8}$ -in wall thickness
	Aluminum top plate, 6-in OD x $\frac{3}{4}$ -in thickness with 1-in-ID center bore and bottom seating flange, 5 $\frac{1}{4}$ -in OD x $\frac{1}{4}$ -in height
Pulling fixture, steel-base insert	Steel tubing, 5 $\frac{3}{4}$ -in OD x 2-in height x $\frac{1}{2}$ -in wall thickness with upper seating flange, 5 $\frac{1}{4}$ -in OD x $\frac{3}{8}$ -in height and bottom kerf flange, 5 $\frac{1}{8}$ -in OD x 5-in ID x 1-in height
Hydraulic pump	Enerpac P-142 two-speed: 1 st stage 200 psi, 2 nd stage 10,000 psi
Hydraulic ram	Enerpac RCH-123, Holl-O-Ram: 10,000 psi, 12 tons
Digital pressure gauge	Parker SCJR 8700-2 PD with min/max display, 0–8,700 psi

c. Safety restraint specifications

Component	Specification
Safety straps (3)	NRS HD tie-down strap, 1-in width x 3-ft length with heavy-duty 1-in cam buckle
Strap brackets (6)	Wall mount (3), 2-in x 2-in aluminum angle, $\frac{1}{4}$ -in thickness x 2-in length
	Pulling fixture (3), aluminum flat bar, $\frac{1}{4}$ -in thickness x 1 $\frac{1}{2}$ -in width x 2-in length

d. Anchors specifications

Component	Specification
Shotcrete anchors (3)	Drill stand (1) and wall-mount strap brackets (2): Hilti HDI drop-in anchor, 5/8-in OD x 2-in length with 1/2-13 UNC x 1 in
Drill stand anchor system	Hilti Kwik-LOK spindle, 7 1/2-in overall length with 1/2-13 UNC x 1 1/2 in and 5/8-in rope thread x 6 in Hilti Kwik-LOK nut, 5/8-in rope thread
Pulling stud	Hilti HIT-TZ threaded rod, 3/8-in OD x 4 3/8-in overall length with 3/8-16 UNC x 1 1/2 in
Epoxy	Hilti HIT-HY 150 MAX
Strap bracket anchors (6)	Wall mount (3), hex bolt, 1/2-13UNC x 1 1/2 in Pulling fixture (3), hex bolt, 1/4-20 UNC x 1 in

*OD = outside diameter

†UNC = Unified National Coarse thread

‡ID = inside diameter

Conversion of Pressure Gauge Bond Strength Test Values to Direct Tensile Force

The ultimate tensile force applied to the test core is determined by converting the maximum hydraulic pressure obtained from the pressure gauge to the maximum tensile force acting normal to the core's failure surface. The tensile force is assumed to act in a direction parallel with the longitudinal axis of the test core, based on the configuration of the drill holes and the design of the direct-tension pulling equipment used for the shotcrete bond strength test. The area of the failure surface is assumed to be equivalent to the cross-sectional area of the test core. The relationship between the hydraulic pressure measured at the pressure gauge and the applied tensile load can be established using a calibrated load cell and the hydraulic components of the pulling system. As the hydraulic ram is cycled through an expected loading range, a series of load cell values are recorded along with the corresponding pressure gauge readings. This data is then plotted, and a trend line representing the data is used to determine the tensile force applied to the test core from the hydraulic pressure gauge reading. Alternatively, a linear regression equation can be calculated from the plotted data and used to calculate the applied tensile force. A typical equation representing this linear relationship is listed below (Equation 1).

$$F_t = (2.7181) p - 10.058 \quad (1)$$

where F_t = tensile force, kN (lbf)
 p = hydraulic pressure, MPa (psi)

The maximum tensile stress at failure is then calculated using Equation 2.

$$\sigma_T = F_T / (\pi d^2 / 4) \quad (2)$$

where σ_T = ultimate tensile stress, MPa (psi)
 F_T = ultimate tensile force, kN (lbf)
 d = diameter of test core, m (in)
 π = 3.14159



*Delivering on the Nation's promise:
safety and health at work for all people
through research and prevention*

To receive NIOSH documents or more information about occupational safety and health topics, please contact NIOSH:

Telephone: 1-800-CDC-INFO

TTY: 1-888-232-6348

CDC INFO: www.cdc.gov/info

or visit the NIOSH Web site at www.cdc.gov/niosh

For a monthly update on news at NIOSH, subscribe to NIOSH eNews by visiting www.cdc.gov/niosh/eNews.

DHHS (NIOSH) Publication No. 2015-107

SAFER • HEALTHIER • PEOPLE™