

A METHOD FOR THE SELECTION OF ROCK SUPPORT BASED ON BOLT LOADING MEASUREMENTS

Stephen P. Signer

Dennis Cox

Joanne Johnston

Spokane Research Center, National Institute of Occupational Safety and Health,
Spokane, Washington, USA

ABSTRACT

A method to assist in the evaluation and selection of roof bolts using in situ measurements of roof bolt loading has been developed by researchers of the Spokane Research Center, National Institute of Occupational Safety and Health. Both axial and bending forces are measured by strain gauges at many locations along the length of fully grouted bolts during various stages of mining. This information is then used to (1) predict bolt loading for variations in bolt spacing, grade, and diameter, (2) calculate the design changes necessary in zones where bending loads are high, and (3) determine if bolt length is adequate. Results from several case studies of full-column bolt loading in coal mine gate roads are used to illustrate the design method. This knowledge will give design engineers a tool for the selection of roof support systems that will improve underground safety by reducing roof bolt failures.

INTRODUCTION

In this paper, a method is described for selecting roof bolt diameter, spacing, and length based on in situ measurements of bolt loading. It is not meant to be used to the exclusion of other design methods and means of analysis. Rather, it should be used as another tool in a well-rounded approach to rock support selection and design. An excellent discussion of rock support design methods is available in Choquet and Hadjigeorgiou (1).

Selection of rock reinforcement depends on many factors that require engineering judgment, such as geology, stress field, geometry, factor of safety, standup time, and estimated risk of roof failure. The intended use of the underground opening will dictate the selection of design loads. In mines, some areas are expected to remain open only for a matter of months, while other areas must remain open for many years. Therefore, more support must be installed where safety or economic interests require greater roof stability.

Civil engineering design approaches include a factor of safety to ensure stability for the life of the project. This is done by limiting the allowable stresses to a percentage of the yield strength or ultimate strength of the material. Mining often allows for the yielding of structures so that the material can be extracted at a minimum cost. This often results in a minimum amount of support installed, and previous research has shown that roof bolts are often loaded well past yield loads (2-4).

The use of strain gauges to measure loading on fully grouted roof bolts has been used successfully to study support-rock interaction mechanics (5-11). Effective use of strain gauges for long-term

underground monitoring requires proper installation to eliminate moisture and long-term creep of the glue line (12). Instrumented bolts should be calibrated and cycled many times to check that the gauge has been properly installed. During field investigations, rock deflections should be measured to detect separations in the horizon above the roof bolts.

DESIGN METHOD

The following assumptions and generalizations are made as part of this design method. The amount of roof bolt loading required to stabilize the immediate roof can vary with respect to distance from ribs and into the roof. This relationship will be referred to as "support load profile." The bolt load depends on amount of area of roof exposed per bolt and the support load profile required for stability. This means that a change in bolt spacing will change bolt load as a function of support load profile. The support load profile consists of both axial and bending loads.

A support load profile can show various aspects of roof behavior. The amount of rock loading that roof bolts are required to support is a function of geology, geometry, and in situ stress fields. In some applications, the skin needs to be controlled while in other areas, roof bolts alone may not be adequate to maintain entry stability. Timing of support installation and distance from the face can also change support loading and roof behavior.

Factors that contribute to bolt loading can be complex and variable. This makes analytical and numerical approaches difficult. A method based on bolt load measurements can be useful to supplement these methods to obtain a better understanding of particular support and rock interactions. Because loading patterns can vary significantly with respect to location, the selection of design loads requires that enough sites be tested to develop confidence in the relationship between bolt load profiles and mining location, geology, geometry, and stress fields. These load profiles can then be extrapolated to an entire area or separate design load profiles can be used when mining conditions vary.

Engineering design typically limits stress to either a percentage of the yield strength or a percentage of the ultimate strength. This safety factor is then applied to prevent material failure. Bolt loads can be axial, bending, and/or shear. Total fiber stress will be a combination of axial loading and bending moments. Axial loading is generally the primary force on a steel bolt. The nature of loading mechanisms and the uncertainties of determining just where loading is taking place makes it impossible to estimate shear loads. When movement takes place along joints, shear loading could be critical in the design of bolt systems, and additional research is required to develop a better understanding of this loading mechanism.

The development of bolt loading profiles requires the installation of instrumented roof bolts during mine development to allow normal rock movement and stress redistribution to load the bolts. The measured bolt locations and axial and bending loads are used to create bolt load profiles. Axial loads cause fiber stress in the bolts according to the formula—

$$\sigma_a = \frac{P}{A} \quad (1)$$

where σ_a = axial stress, Pa,

and $P =$ load, N,
 $A =$ steel area.

Bending moments measured by the instrumented bolts involve several factors that a design engineer should consider. Maximum bending moments can be localized and may not be accurately measured with an instrumented bolt. Bending is measured in only one orientation because of the limitations of the instrument. If possible, the bolts should be rotated so that they measure the highest estimated bending moment. Bending moments can be caused by joint movement, rotation of large blocks, and/or differential loading in mats and meshes. Considering the source and prevalence of bending loads when using the design formulas is important. Bending loads cause fiber stress in the bolts according to the formula—

$$\sigma_b = \frac{M}{S_x} \quad (2)$$

where $\sigma_b =$ bending stress, Pa,
 $M =$ moment, N-m,
 and $S_x =$ section modulus, m³.

Total fiber stress then becomes—

$$\sigma_f = \sigma_a \pm \sigma_b \leq \sigma_{max} \quad (3)$$

where $\sigma_f =$ total fiber stress
 and $\sigma_{max} =$ allowable fiber stress.

Bolt spacing is the primary variable manipulated in the design process. Both axial and bending loads measured with instrumented bolts can be estimated when using a new bolt spacing based on the following equations—

$$\frac{P}{S_1 S_2} = \frac{P_d}{S_{1,d} S_{2,d}} \quad (4)$$

and

$$\frac{M}{S_1 S_2} = \frac{M_d}{S_{1,d} S_{2,d}} \quad (5)$$

where $S_1 =$ bolt spacing across the opening of instrumented bolts,
 $S_2 =$ bolt spacing down the entry of instrumented bolts,

and

$$\begin{aligned}
 S_{1d} &= \text{new bolt spacing across the opening,} \\
 S_{2d} &= \text{new bolt spacing down the entry,} \\
 P_d, M_d &= \text{new load and moment values.}
 \end{aligned}$$

By solving for P_d and M_d and substituting equations 4 and 5 for 1 and 2, and solving for equation 3, then—

$$\sigma_t = \frac{S_{1d} S_{2d} P}{S_1 S_2 A} + \frac{S_{1d} S_{2d} M}{S_1 S_2 S_x} \leq \sigma_{\max} \quad (6)$$

Both P and M are measured axial forces and bending moments derived from the instrumented bolts. The values of A and S_x are derived from the member selected for design considerations. σ_t must be less than or equal to the selected maximum stress. Total stresses should be calculated for each bolt location to determine the highest value and must be less than or equal to a design stress based on the factor of safety selected. Safety, engineering judgment, and cost considerations will result in a design selection based on variations in bolt diameter, strength, and spacing.

Bolt diameter and bolt length are two of the major variables changed in the design process. These factors can have a significant effect on roof stability. Adequate anchorage length is also critical to ensuring the stability of the bolted horizon (13). Anchorage length can be evaluated by examining load distribution with respect to the distance from the embedded end of the roof bolt and comparing to estimates of rock anchorage in that type of stratum.

CASE HISTORIES

To illustrate the use of this method, three sets of data from different coal mines were evaluated. Bolts used in these tests were standard grade 60, No. 6 rebar bolts milled with a 6.4-mm-wide by 3.2-mm-deep slot along each side. Strain gauges were installed as shown in figure 1. After milling, the cross-sectional area was 2.39 cm² and the section modulus was 0.338 cm³. The instrumented bolts were calibrated in a uniaxial test machine to correlate voltage change to load change. During installation, the bolts were oriented with the strain gauges parallel to the ribs to measure localized bending effects in the mine roof. The data collection system was an Omnidata Polyrecorder 516-C. A completion box was made that provided 5-V excitation and completion resistors for the Wheatstone bridge circuits used to measure strain gauge voltage changes.

Five grade 60 bolts were tested to failure to determine the strength and yield point of the bolt after the slots had been milled. The slotting process reduced bolt strength by approximately 10%. A typical load strain curve from one of these tests is shown in figure 2. When the data from the instrumented bolts were reduced, the correlation coefficients from the axial calibrations were used to convert voltage changes to load changes. This process was accurate to ± 0.4 kN. When bolt load levels exceeded the yield point of the steel, voltage readings were converted to strain readings, and these values were used in figure 2 to estimate bolt loading. However, converting voltage to strain is not as accurate as converting voltage to load.

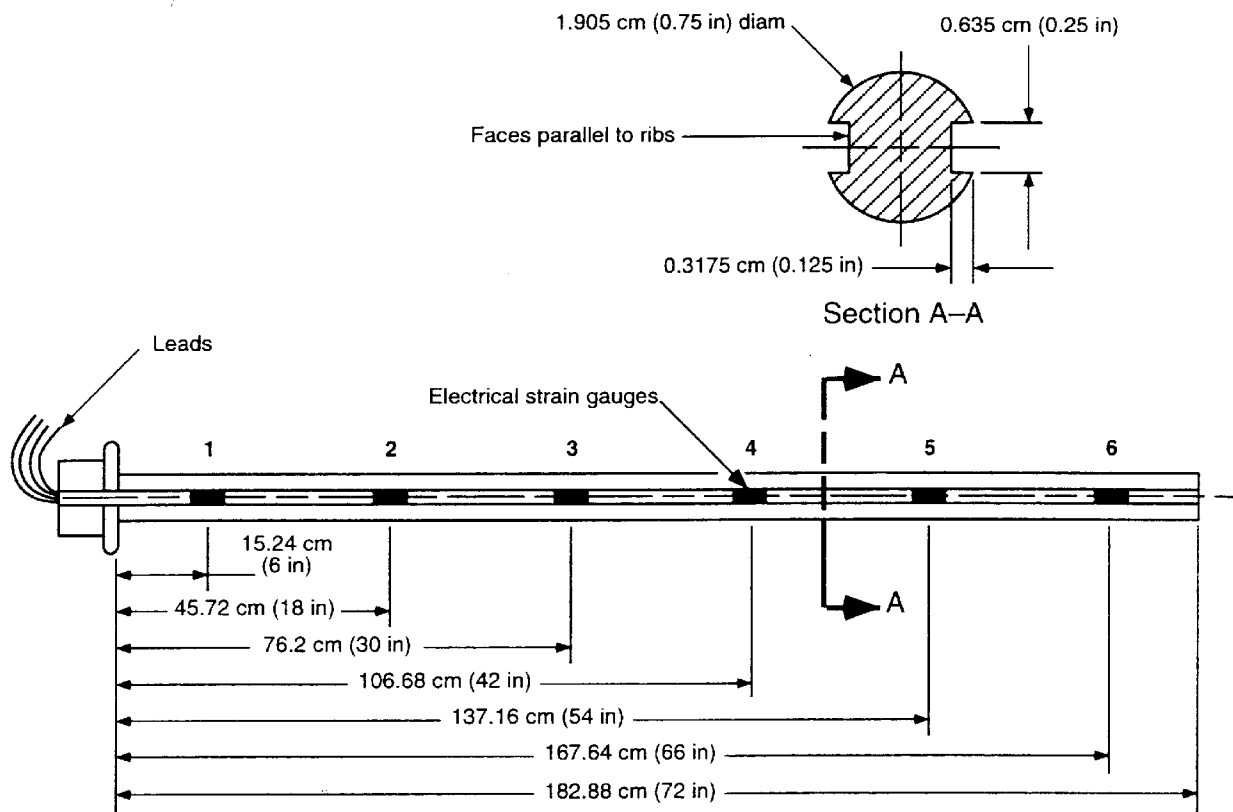

Figure 1.—Instrumented roof bolt

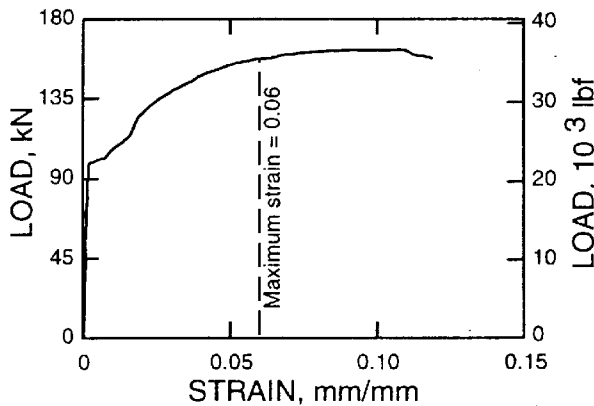

Figure 2.—Stress-strain curve of slotted roof bolt

Site 1

The first test site was located in a two-entry gate road where the coal seam is approximately 2.5 m thick, and overburden is between 210 and 240 m deep. The mine roof is a competent mudstone interspersed with very fine grained sandstone and siltstone. Grouted bolts 1.8 m long, spaced in a square pattern approximately 1.2 by 1.2 m were used as the main roof support. Axial and bending loads shown in figure 3 form the load profile after the pass of the second longwall panel. Bending moments measured were primarily caused by rock loading in the mesh. Maximum fiber stresses are shown in table 1.

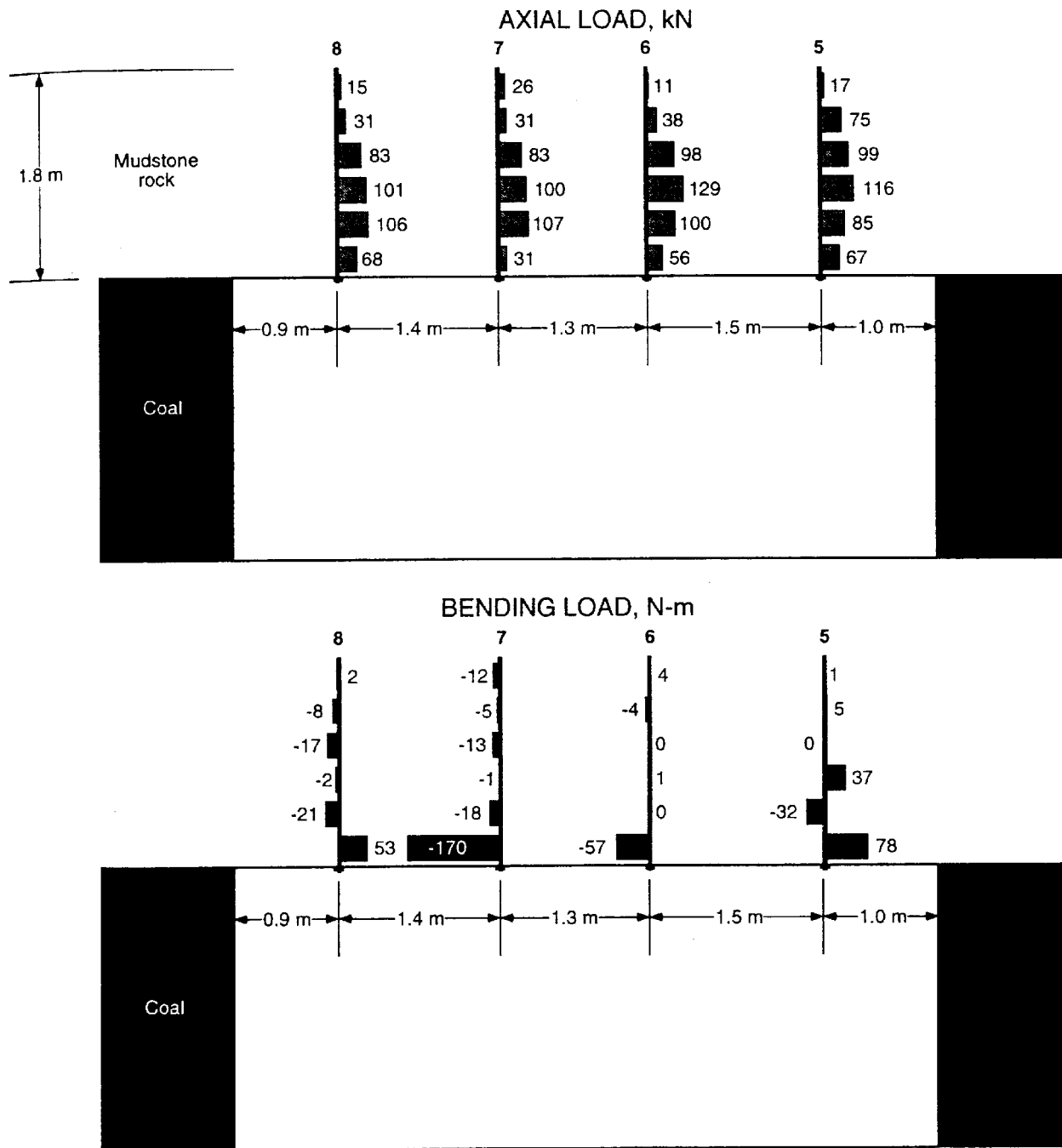

Figure 3.—Load profiles for test site 1

Table 1.—Maximum fiber stress for test site 1, megapascals

Bolt	Strain gauge station					
	1	2	3	4	5	6
5 ...	300	365	493	415	316	70.0
6 ...	250	418	539	410	161	45.9
7 ...	172	451	420	352	129	110
8 ...	298	451	422	352	132	65.5

The selected design stress for this test site was 414 MPa. Every roof bolt exceeded this value. Reducing the spacing between bolt rows, increasing the number of bolts per row, and increasing the diameter of the bolt are three ways to reduce fiber stress. Using these methods and equation 6 produced the figures shown in table 2.

Table 2.—Roof bolt design alternatives

Number of bolts	S_{d1} , m	S_{d2} , m	Bolt diameter, mm
4	1.22	0.90	18, No. 6 rebar
5	1.02	1.08	18, No. 6 rebar
4	1.22	1.32	22, No. 7 rebar

These selections assume an equal spacing of roof bolts. If there were sufficient data to suggest a consistent pattern of bolt load profiles, then irregular bolt spacings could be used. In this case, the safety factors should be increased to provide for variations that might overload the roof bolts. Each of these options would limit bolt stress to less than 414 MPa. The stress distribution along the bolt length indicates that there would be adequate anchorage length if a 1.5-m-long bolt were used in place of the 1.8-m-long bolt.

Site 2

The second test site was located in a four-entry gate road with yield abutment pillars. Overburden at the test site is approximately 670 m. A 30-cm-thick layer of incompetent drawrock overlies the coal seam. The immediate mine roof is formed by a fossiliferous shale that grades into thinly interbedded shales and coals. This seam is overlain by a 30-cm-thick coal seam. Where the drawrock is thin, it falls during extraction of the coal together with the coal rider seam. The main roof above the rider seam consists of 30 to 60 cm of competent siltstone overlain by massive sandstone. Instrumented bolts were installed in areas where the rider seams remained intact. Row spacings were approximately 1.22 m.

Axial and bending loads (figure 4) show the load profile after entry development. Bending moments were significantly higher at this test site. High horizontal stresses produced lateral movements at the

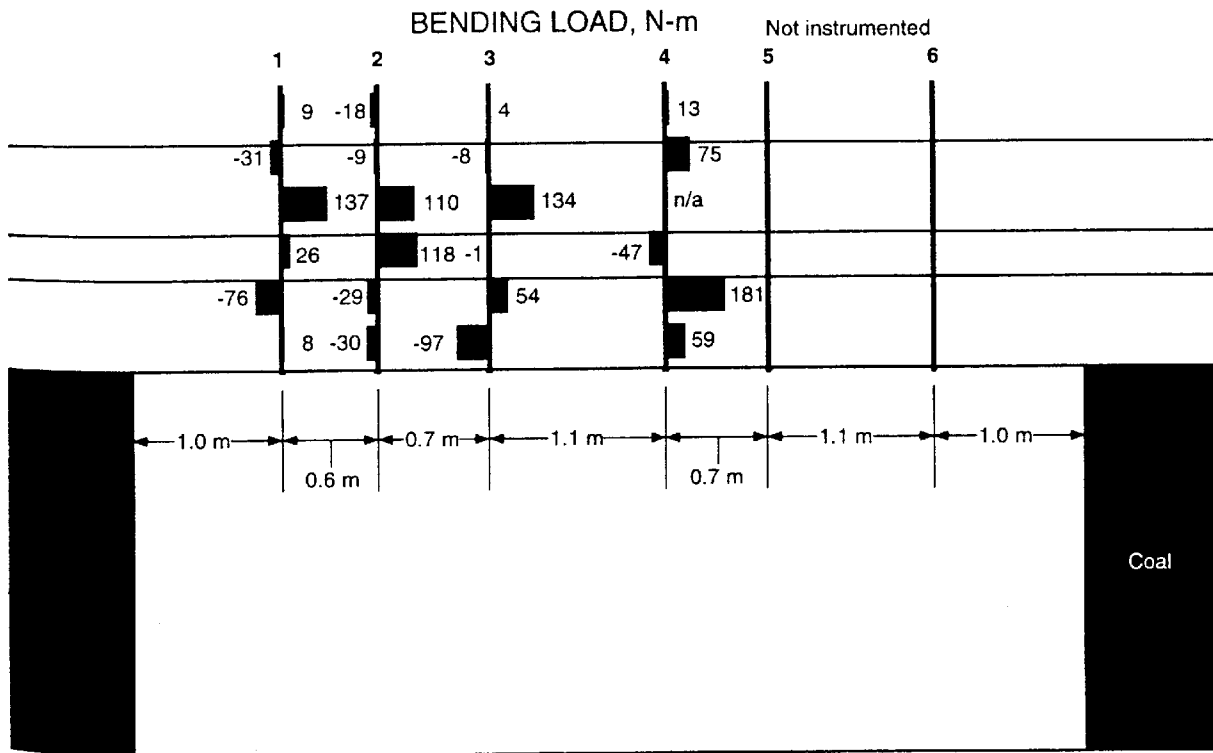
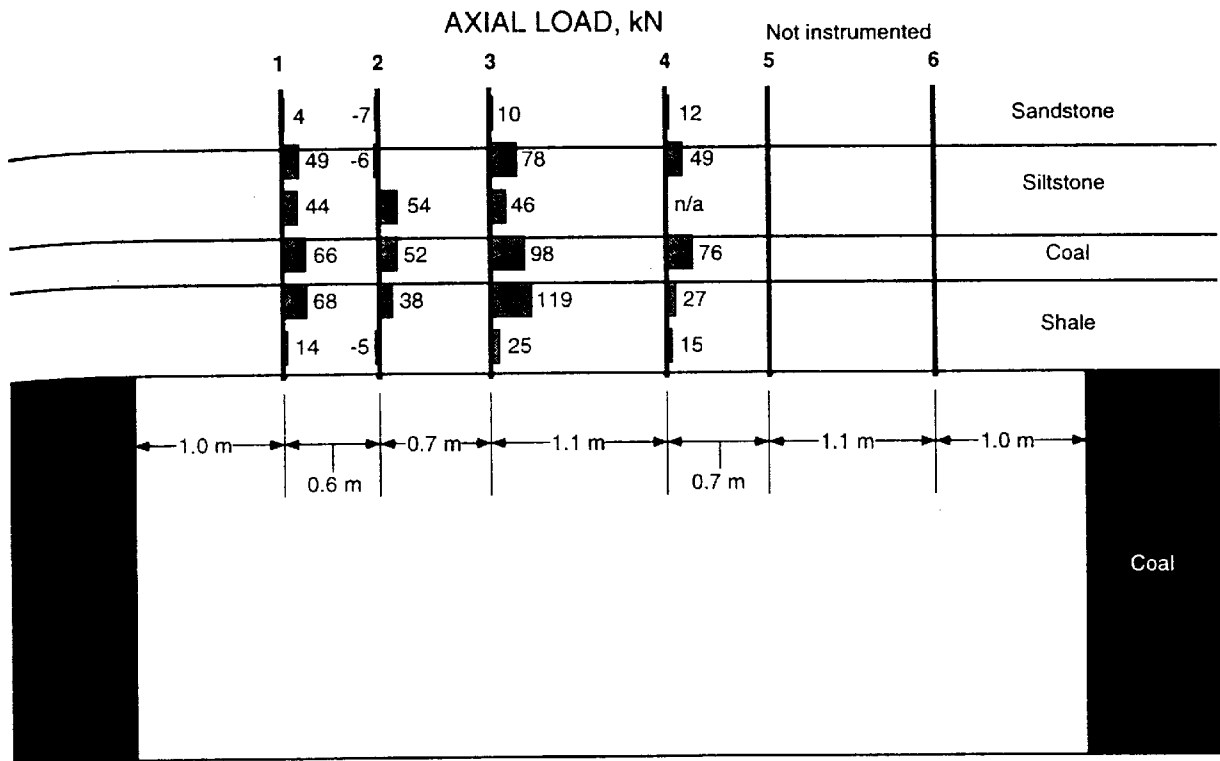

Figure 4.—Load profiles for test site 2

riber seam location, which contributed to these bending stresses. Maximum fiber stress was 513 MPa on bolt 3 at 46 cm from the mine roof.

The selected design stress for this test site was 331 MPa. A lower stress limit was selected because maximum bending loads may be reached between strain gauges. Also, the amount of data at this test location was not extensive. Using six No. 6 bolts per row, the spacing between the rows was reduced to 0.83 m, and the spacing between the bolts in the row was 0.86 m. If five No. 7 bolts were used per row, then the bolt spacing would be 1 by 1 m.

Site 3

The third test site was in a two-entry gate road. The coal seam is approximately 4.3 m thick and has a 16° pitch. Overburden at the test site is approximately 335 m deep. The entry was cut approximately 3 m high, and top coal was left on the roof and the floor. The top coal was approximately 0.5 m thick on the downdip side of the entry and 1.5 m on the updip side. Above the top coal, the immediate roof was a very low strength carbonaceous mudstone.

Row spacing of the roof bolts was approximately 1.2 m. Axial and bending loads (figure 5) show the load profile after the pass of the first longwall panel. Maximum fiber stresses are shown in table 3.

Table 3.—Maximum fiber stress for test site 3, megapascals

Bolt	Strain gauge station					
	1	2	3	4	5	6
1 . .	156	423	402	411	343	315
2 . .	108	554	319	406	382	682
3 . .	117	225	434	420	413	339
4 . .	104	252	432	412	410	196
5 . .	130	426	411	416	435	400

The selected design stress for this test site was 414 MPa. The ultimate strength of the instrumented bolts was approximately 684 MPa. Station 6 on bolt 2 showed a combined stress that was very close to failure. It should be noted that the accuracy of the strain gauges decreased considerably at greater elongations, so the high stress readings should be taken as estimates.

The main concern at this test site was the lack of adequate anchorage length at the ends of the roof bolts. Cutters would form on the downdip side of the entry, and the bolts would appear to loose anchorage in the weak mudstone. The bolt load profile shows that high stresses were too close to the end of the bolts. Increasing bolt diameter, reducing bolt spacing, and/or increasing the number of bolts probably would not be enough to prevent this type of roof failure. A longer bolt that is angled over the ribs could solve the anchorage problem.

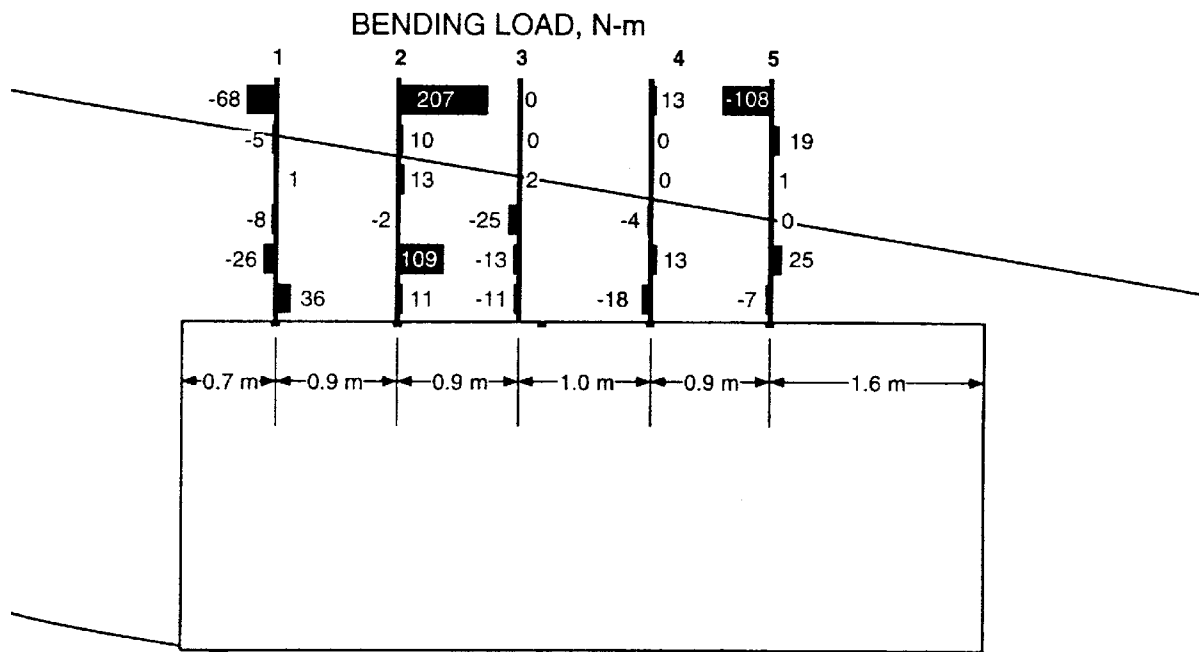
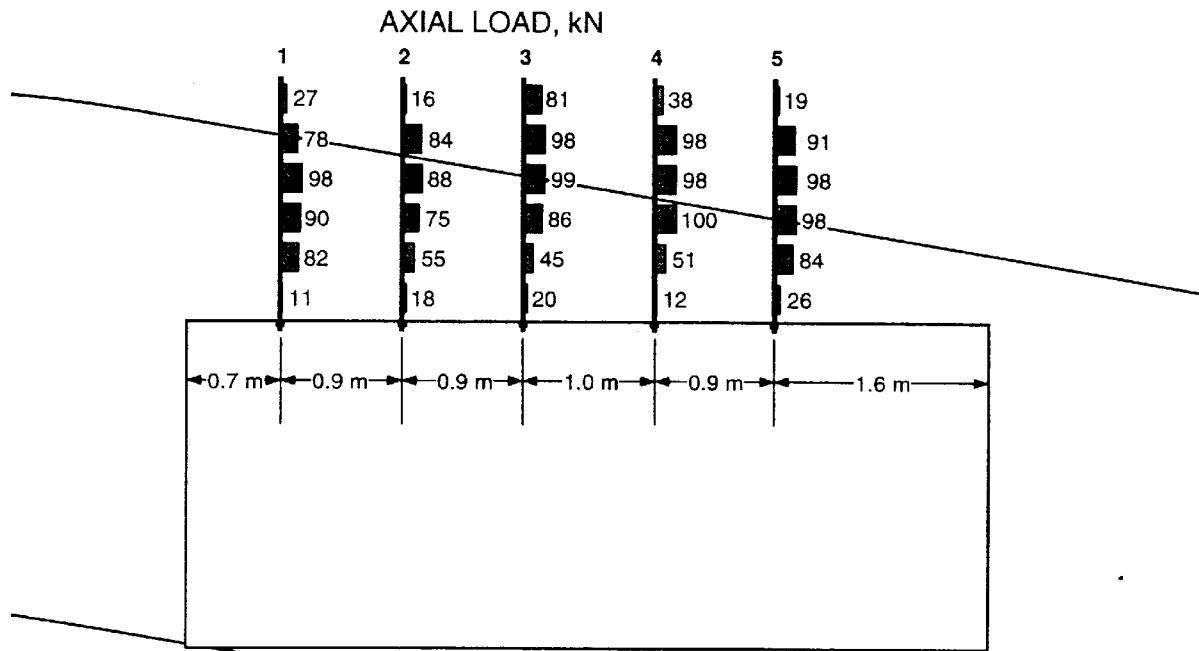

Figure 5.—Load profiles for test site 3

Every roof bolt exceeded the design stress value so other corrective action is required. Reducing the spacing between bolt rows, increasing the number of bolts per row, and increasing the diameter of the bolt are three ways to reduce fiber stress. Using these methods and equation 6 produced the results shown in table 4.

Table 4.—Roof bolt design alternatives for test site 3

Number of bolts	S_{d1} , m	S_{d2} , m	Bolt diameter, mm
5	1.02	1.07	18, No. 6 rebar
4	1.22	0.89	18, No. 6 rebar
4	1.22	1.28	22, No. 7 rebar

SUMMARY

All of the design selections incorporated an evenly spaced bolting pattern. The design loads combined maximum axial and bending loads. Additional refinements could be made by allowing uneven spacings across the entry and using the exact load profile for the design loads. If this approach is used, the factor of safety should be increased to allow for variations and anomalies. After redesigning the bolting pattern, the pattern should be measured to see how close estimated loads compare with actual loads. In situ tests should also be conducted to establish anchorage capacities in the roof rock. This method could be used effectively for the development of an engineered solution having a selected factor of safety for selecting bolt diameter, spacing, and length. The end result will be fewer roof falls and safer conditions underground.

REFERENCES

1. Choquet, P., and J. Hadjigeorgiou. "The Design of Support for Underground Excavations." Paper in *Comprehensive Rock Engineering: Principles, Practice, and Projects*. V. 4, Pergamon, 1993, pp. 313-345.
2. Signer, S. P., and S. D. Jones. "A Case Study of Grouted Roof Bolt Loading in A Two-Entry Gate Road." Paper in *9th International Conference on Ground Control in Mining: Proceedings*, ed. by Syd S. Peng (Morgantown, WV, June 4-10, 1990). Dept. Min. Eng., WV Univ., 1990, pp. 35-41.
3. Signer, S. P., C. Mark, G. Franklin, and G. Hendon. "Comparisons of Active Versus Passive Bolts in a Bedded Mine Roof." Paper in *Proceedings of 12th Conference on Ground Control in Mining*, ed. by S. S. Peng (Morgantown, WV, Aug. 3-5, 1993). Dept. Min. Eng., WV Univ., 1993, pp. 16-23.
4. Signer, S. P. "Field Evaluations of Grouted Roof Bolts." Paper in *New Technology for Long-wall Ground Control. Proceedings: U.S. Bureau of Mines Technology Transfer Seminar*, comp. by C. Mark, R. J. Tuchman, R. C. Repshar, and C. L. Simon. U.S. Bur. Mines Spec. Pub. 01-94, 1994, pp. 91-101.

5. Serbousek, M. O., and S. P. Signer. "Load Transfer Mechanics in Fully Grouted Roof Bolts." Paper in *Fourth Conference on Ground Control in Mining* (Morgantown, WV, July 22-24, 1985). Dept. Min. Eng., WV Univ., 1985, pp. 32-40.
6. Serbousek, M. O., and S. P. Signer. Linear Load Transfer Mechanics of Fully Grouted Bolts. U.S. Bur. Mines Rep. Invest. 9135, 1987, 17 pp.
7. Maleki, H., S. P. Signer, M. E. King, and P. A. Edminster. "Evaluation of Support Performance in a Highly Stressed Mine." Paper in *Proceedings of 13th International Conference on Ground Control in Mining*, ed. by S. S. Peng (Morgantown, WV, Aug. 2-4, 1994). Dept. Min. Eng., WV Univ., 1994, pp. 9-17.
8. Larson, M., C. Stewart, M. Stevenson, M. King, and S. Signer. "A Case Study of a Deformation Mechanism Around a Two-Entry Gateroad System Involving Probable Time-Dependent Deformation." Paper in *Proceedings of 14th International Conference on Ground Control in Mining*, ed. by S. S. Peng (Morgantown, WV, Aug. 1-3, 1995). Dept. Min. Eng., WV Univ., 1995, pp. 295-304.
9. Farmer, I. W. "Stress Distribution Along a Resin Grouted Anchor." *Int. J. Rock Mech. Min. Sci. & Geomech.*, v. 12, 1975, pp. 347-351
10. Dunham, R. K. "Anchorage Tests on Strain-Gaged Resin Bonded Bolts." *Tunnels and Tunneling*, v. 8, No. 6, Sept. 1974, pp. 73-76.
11. Gale, W. J., and M. W. Fabjanczyk. "Application of Field Measurement Techniques to the Design of Roof Reinforcement Systems in Underground Coal Mines." Proc., 13th Cong. of Council of Instit. Min. and Metal., Singapore, pp. 135-141.
12. Johnston, J. L., and D. J. Cox. Instrumentation Procedures for Fully Grouted Rock Bolts. U.S. Bur. Mines Inform. Cir. 9341, 1993, 10 pp.
13. Littlejohn, S. "Overview of Rock Anchorages." Paper in *Comprehensive Rock Engineering: Principles, Practice, and Projects*. V. 4, Pergamon, 1993, pp. 413-450.