

**RI 9416**

REPORT OF INVESTIGATIONS/1992

## **Influence of Electrode Material on Spark Ignition Probability**

By Jeffrey Shawn Peterson

UNITED STATES DEPARTMENT OF THE INTERIOR



BUREAU OF MINES

**Report of Investigations 9416**

# **Influence of Electrode Material on Spark Ignition Probability**

**By Jeffrey Shawn Peterson**

**UNITED STATES DEPARTMENT OF THE INTERIOR**  
**Manuel Lujan, Jr., Secretary**

**BUREAU OF MINES**  
**T S Ary, Director**

**Library of Congress Cataloging in Publication Data:**

**Peterson, Jeffrey Shawn.**

Influence of electrode material on spark ignition probability / by Jeffrey Shawn Peterson.

p. cm. — (Report of investigations; 9416)

Includes bibliographical references (p. 19).

Supt. of Docs. no.: I 28.23:9416.

1. Mine explosions—Prevention. 2. Methane. 3. Electric spark. 4. Electrodes, Tungsten—Testing. 5. Electrodes, Cadmium—Testing. I. Title. II. Series: Report of investigations (United States. Bureau of Mines); 9416.

TN23.U43 [TN313] 622 s—dc20 [622'.82] 91-7375 CIP

## CONTENTS

|                                       | <i>Page</i> |
|---------------------------------------|-------------|
| Abstract . . . . .                    | 1           |
| Introduction . . . . .                | 2           |
| Acknowledgments . . . . .             | 3           |
| Experimental design . . . . .         | 3           |
| Method of computer analysis . . . . . | 6           |
| Test results and analysis . . . . .   | 6           |
| Conclusions . . . . .                 | 19          |
| References . . . . .                  | 19          |

## ILLUSTRATIONS

|   |    |
|---|----|
| 1. Breakflash apparatus used to collect spark ignition data . . . . .                               | 2  |
| 2. Test circuit used to obtain spark ignition data for resistor testing . . . . .                   | 3  |
| 3. Test circuit used to obtain spark ignition data for inductor testing . . . . .                   | 3  |
| 4. Test circuit used to obtain spark ignition data for capacitor testing . . . . .                  | 4  |
| 5. Disk electrode . . . . .   | 4  |
| 6. Acceptable probability of ignition range of $5 \times 10^{-4}$ to $1.5 \times 10^{-3}$ . . . . . | 5  |
| 7. Diagram of gas mixing system . . . . .   | 5  |
| 8. Diagram of gas flow . . . . .  | 5  |
| 9. Probability of ignition versus current results for 30-V dc resistor circuit . . . . .            | 7  |
| 10. Probability of ignition versus current results for 40-V dc resistor circuit . . . . .           | 8  |
| 11. Probability of ignition versus current results for 50-V dc resistor circuit . . . . .           | 9  |
| 12. Probability of ignition versus current results for 1-mH inductor circuit . . . . .              | 10 |
| 13. Probability of ignition versus current results for 10-mH inductor circuit . . . . .             | 11 |
| 14. Probability of ignition versus current results for 100-mH inductor circuit . . . . .            | 12 |
| 15. Probability of ignition versus current results for 600-mH inductor circuit . . . . .            | 13 |
| 16. Probability of ignition versus voltage results for 1.2- $\mu$ F capacitor circuit . . . . .     | 16 |
| 17. Probability of ignition versus voltage results for 10.3- $\mu$ F capacitor circuit . . . . .    | 16 |
| 18. Probability of ignition versus voltage results for 107- $\mu$ F capacitor circuit . . . . .     | 17 |
| 19. Probability of ignition versus voltage results for 1,310- $\mu$ F capacitor circuit . . . . .   | 17 |
| 20. Elemental disk material boiling point versus resistor circuit ignition current . . . . .        | 18 |
| 21. Elemental disk material boiling point versus inductor circuit ignition current . . . . .        | 18 |

## TABLES

|   |    |
|---|----|
| 1. Capacitor circuit specifications . . . . .   | 4  |
| 2. Voltage-current versus probability of ignition for aluminum disks . . . . .          | 7  |
| 3. Voltage-current versus probability of ignition for brass disks . . . . .             | 8  |
| 4. Voltage-current versus probability of ignition for cold-rolled steel disks . . . . . | 9  |
| 5. Voltage-current versus probability of ignition for copper disks . . . . .            | 10 |
| 6. Voltage-current versus probability of ignition for lead disks . . . . .              | 11 |
| 7. Voltage-current versus probability of ignition for stainless steel disks . . . . .   | 12 |
| 8. Voltage-current versus probability of ignition for tin disks . . . . .               | 13 |
| 9. Safety factors and ignition currents for resistor circuits . . . . .                 | 14 |
| 10. Safety factors and ignition currents for inductor circuits . . . . .                | 14 |
| 11. Safety factors and ignition voltages for capacitor circuits . . . . .               | 15 |
| 12. Values of C and D for ignition current versus boiling point equation . . . . .      | 15 |

### UNIT OF MEASURE ABBREVIATIONS USED IN THIS REPORT

|                      |                                |      |                          |
|----------------------|--------------------------------|------|--------------------------|
| °C                   | degree Celsius                 | min  | minute                   |
| cm <sup>3</sup> /min | cubic centimeter<br>per minute | mm   | millimeter               |
| in                   | inch                           | ms   | millisecond              |
| kohm                 | kilohm                         | rev  | revolution               |
| L/min                | liter per minute               | rpm  | revolution per<br>minute |
| mA                   | milliampere                    | s    | second                   |
| μF                   | microfarad                     | V    | volt                     |
| mH                   | millihenry                     | V dc | volt, direct current     |

### OTHER ABBREVIATIONS USED IN THIS REPORT

|                |  |                |  |
|----------------|--|----------------|--|
| A, C, D, E     | constant terms                                 | NDIR           | nondispersive infrared                       |
| B              | slope of graph                                 | N <sub>i</sub> | number of ignitions                          |
| BP             | boiling point                                  | N <sub>s</sub> | number of sparks                             |
| d              | acceptable probability of<br>ignition error    | p <sub>i</sub> | probability of ignition                      |
| IC             | ignition current                               | q              | probability of no ignition                   |
| I <sub>c</sub> | current yielding<br>p <sub>i</sub> = 1/1,000   | S              | spark sample size                            |
| IEC            | International Electro-<br>technical Commission | V <sub>c</sub> | voltage yielding p <sub>i</sub><br>= 1/1,000 |
|                |  | Z              | Z score                                      |

# INFLUENCE OF ELECTRODE MATERIAL ON SPARK IGNITION PROBABILITY

By Jeffrey Shawn Peterson<sup>1</sup>

---

## ABSTRACT

The testing procedures of the U.S. Mine Safety and Health Administration specify that intrinsic safety acceptance tests be conducted using a standard tungsten-cadmium electrode configuration in the break-flash apparatus. However, in realistic mining environments, other materials may be more likely sources of sparking. Information defining the probability of spark ignition between common materials such as aluminum, brass, copper, lead, tin, cold-rolled steel, and stainless steel is of more practical value in determining ignition hazards. The U.S. Bureau of Mines has completed an investigation of the influence of material on the ignition probability using the breakflash apparatus. By comparing ignition currents or ignition voltages corresponding to a probability of one ignition per thousand sparks to those found previously for cadmium, a margin of safety may be estimated for each material. This report presents the results of an investigation into the influence of disk electrode material on the probability of ignition.

---

<sup>1</sup>Electrical engineer, Pittsburgh Research Center, U.S. Bureau of Mines, Pittsburgh, PA.

## INTRODUCTION

Intrinsic safety (IS) is concerned with the ignition of explosive gases by electrical or thermal means. In regard to mining, the primary objective of IS is the prevention of methane explosions caused by accidental energy discharge from low-energy electrical/electronic devices. Two elements must be present to create a potentially hazardous condition: an ignitable fuel-air mixture and an ignition source. In poorly ventilated areas, methane released during the mining process may accumulate in explosive concentrations. The methane may then be ignited by a malfunctioning electrical device. Because IS utilizes energy-limiting techniques, it is effectively limited in use to low-power applications. IS is only one of several techniques used to prevent explosions in such hazardous areas. Other techniques, such as explosion-proof enclosures, require a physical barrier between the electrical circuit and the hazardous environment. If this physical barrier is breached, a margin of safety cannot be maintained; a situation that does not exist if IS techniques are used.

The U.S. Mine Safety and Health Administration (MSHA) must approve all devices intended for use in or inby the last open crosscut or in return air underground as per 30 CFR 18 (1).<sup>2</sup> Because certain areas of these specifications are somewhat vague, American National Standards Institute/Underwriters Laboratories (ANSI/UL) Standard 913 (2), with some modifications, is presently used as the de facto standard for electrical/electronic device approval. The ignition current/voltage curves available in ANSI/UL 913 are frequently used in the approval process. Initially, the energy discharge of the device is compared with the curves. Those devices with energy discharges well below the curves may be approved by electrical inspection only. Other devices, whose energy discharge falls near the curve, must be ignition tested using a device similar to the breakflash apparatus shown in figure 1 (2, p. 38).

The breakflash apparatus simulates the making and breaking of a circuit using four tungsten wire electrodes and a single cadmium disk electrode. The electrode materials used in the breakflash apparatus were not chosen arbitrarily. Tungsten was chosen as the wire material for its toughness, resulting in increased electrode life. Cadmium was chosen as the disk material for its ability to produce ignitions at the lowest currents or voltages known for any material. The electrodes counterrotate—the wire electrode shaft at 80 rpm and the disk electrode shaft at 19 rpm—to create sparks in an energized circuit. This sparking serves to ignite the methane-air mix in the surrounding explosion chamber. The circuit under test (CUT) is connected in series or parallel with the

breakflash apparatus. MSHA specifications state that two worst case circuit faults should be added to the CUT and 1.5 times the normal energy discharge of the device should be applied at the point of test. Two ignition tests, each consisting of 1,000 rev of the breakflash apparatus, are conducted. If there are no ignitions of the test gas, the device is approved as intrinsically safe.

The approval process is quite safe as there have been no explosions traced to intrinsically safe devices. MSHA employs a "safety factor" in its approval testing. By increasing the energy at the point of test by 50% over the conditions of actual use, MSHA testing allows for variations in supply currents (voltages), circuit tolerances, gas concentrations, environmental conditions, and other factors that may influence the probability of igniting the test gas. In addition, the cadmium disk electrode in the breakflash apparatus causes ignition at lower current (voltage) levels than disk electrodes of copper or steel. This in effect, creates a hidden safety factor in addition to the

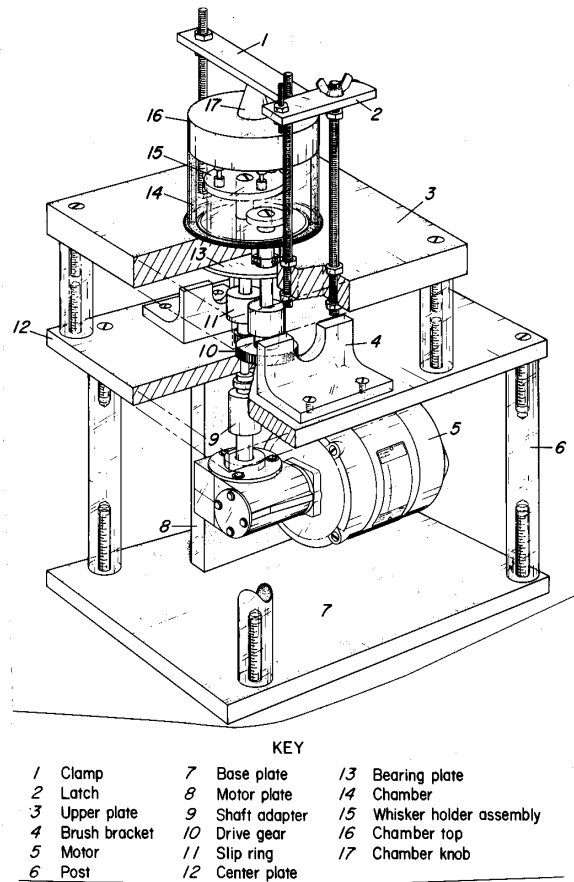

Figure 1.—Breakflash apparatus used to collect spark ignition data.

<sup>2</sup>Italic numbers in parentheses refer to items in the list of references at the end of this report.

50% energy increase. The magnitude of this additional material-based safety factor is unknown.

When sparking occurs in actual use, the materials acting as electrodes will likely be the materials more commonly found in the mining environment. Although cadmium is commonly used in mining environments for plating of cases, nuts, bolts, etc., other materials may be more common. As examples, steel is frequently used in the construction of equipment enclosures and copper is used extensively as an electrical conductor. Spark test data generated using disks of steel, copper, and other materials commonly found in mining environments are essential in determining their effect upon the probability of ignition. Computer analysis of these data yields ignition currents

(voltages) corresponding to specific probability of ignition when sparking occurs between steel, copper or other electrodes. By comparing these currents (voltages) to previous U.S. Bureau of Mines research involving cadmium disks, a safety factor may be assigned for each material. This safety factor is more precisely defined as the ratio of the ignition currents or ignition voltages that yields an equal probability of ignition when testing two materials under similar test conditions. Cadmium was used as a reference material and assigned a safety factor of 1.00.

As part of its program to enhance safety in the mines, the Bureau has conducted an investigation of the influence of disk electrode material on the probability of ignition.

## ACKNOWLEDGMENTS

The author wishes to thank the following Pittsburgh Research Center employees: Robert Kemp, physical science technician, for his efforts in compiling the test data for this project, Arthur Hudson, electronics technician, for

his instrumentation of the project, and Anne Oyler, computer programmer, for her computer analysis of the test results.

## EXPERIMENTAL DESIGN

Test circuits investigated included simple resistor, inductor, and capacitor circuits (figs. 2-4). For the resistor circuit, decade boxes consisting of noninductive resistors were utilized to vary current over the range of test voltages. Voltages below 50 V dc represent the most likely range commonly found in low-power devices in the mine. For disk materials other than cadmium, testing at or below 20 V dc became impractical. The increased currents necessary to conduct testing at  $\leq 20$  V dc could raise the wire electrode temperature to the point where a hot-wire ignition is possible. Spark ignition and hot-wire ignition

mechanisms are different. Spark ignitions require the transfer of electrical energy from an arc to the gas mix. With hot-wire ignitions, thermal energy is imparted to the test gas by the electrically heated wire. Eventually, the gas will become so hot that it will ignite spontaneously. Because hot-wire ignitions could render low-voltage ( $\leq 20$  V dc) resistor circuit test results invalid, test voltages were limited to 30, 40, and 50 V dc.

Air-core inductors were used in the inductor circuit testing. Noninductive decade boxes were again used to

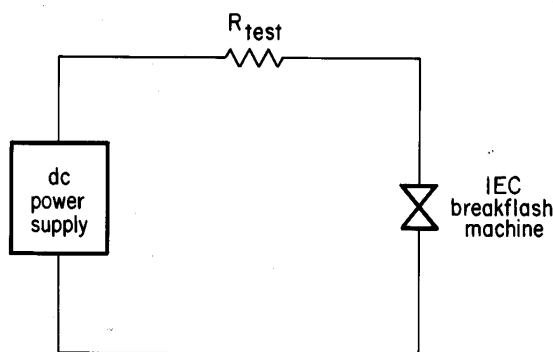

Figure 2.—Test circuit used to obtain spark ignition data for resistor testing.

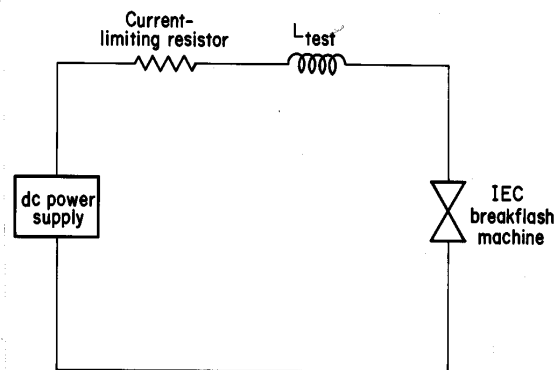

Figure 3.—Test circuit used to obtain spark ignition data for inductor testing.



vary current in 24-V dc circuits using test inductances of 1, 10, 100, and 600 mH.

Aluminum electrolytic capacitors were used to conduct the capacitor circuit testing because they are the most common large-value capacitors used in electronic construction. Test capacitor characteristics are listed in table 1.<sup>3</sup> The charging resistor was calculated to provide a charging time constant of approximately 100 ms for the capacitor. If this resistance was too small, the power supply would cause current to flow into the arc as the capacitor discharged. It was imperative that the energy contribution from the power supply be minimal compared with that of the capacitor discharge at contact. Checks of the discharge time for each test capacitor confirmed that the power supply contribution was minimal. If the value of the charging resistance was too large, then the time constant would be too long, causing the capacitor to discharge at less than the full test voltage. One tungsten wire electrode was used in capacitor circuit testing, and the speed of the breakflash was slowed so that the capacitor could charge for approximately five time constants. As a result, capacitor circuit tests progressed much more slowly than resistor or inductor circuit testing. The charge-discharge cycle of the capacitor was also monitored with an oscilloscope.

Table 1.—Capacitor circuit specifications

|                                     | Mallory |         | Sprague |        |
|-------------------------------------|---------|---------|---------|--------|
|                                     | TC56    | TC50100 | TE1407  | TE1211 |
| Capacitance . . . $\mu$ F.          | 1.2     | 1,310   | 10.3    | 107    |
| Charging resistance . . . kohm.     | 92.9    | 0.075   | 9.67    | 0.935  |
| Charging time constant . . . . . s. | 0.111   | 0.098   | 0.100   | 0.100  |

Using the specifications in ANSI/UL 913 detailing the cadmium disk, disks of materials commonly found in mining environments were machined (fig. 5) (2, p. 39). These materials included aluminum, lead, copper, tin,

<sup>3</sup>Reference in text or tables to specific products does not imply endorsement by the U.S. Bureau of Mines.

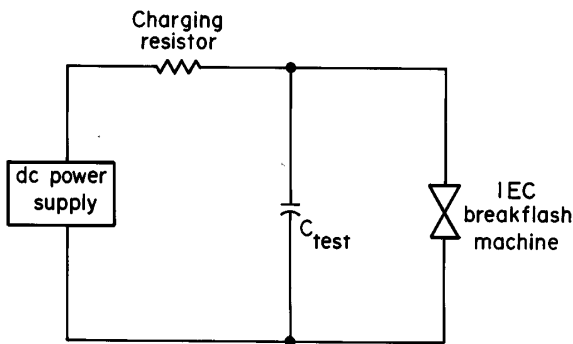

Figure 4.—Test circuit used to obtain spark ignition data for capacitor testing.

brass, cold-rolled steel, and stainless steel. Because ignitions are less likely to occur with new disks, each disk required a 20-min break in period in an unenergized circuit.<sup>4</sup> With only two exceptions, one disk of each material was used in each type of circuit. During resistor circuit testing, the softness of tin and lead resulted in wearing inconsistent with that of the other materials, facilitating the need of two disks of each of these materials to complete the work. The tungsten wire electrodes had a diameter of 0.020 mm and an unsupported length of 11 mm. To prolong their usable life, the tungsten wire electrodes were annealed prior to use. Unfortunately, these electrodes were still susceptible to splintering, breaking, and wearing down. They were replaced when visibly worn, or after 4,500 sparks for resistor and inductor circuit testing, or 1,000 sparks for capacitor circuit tests. If any two-wire electrodes failed during resistor or inductor circuit testing, the experiment was halted and all four electrodes were replaced. The electrodes counterrotated to create the sparks, which were then electronically counted. The resulting ignitions were counted in a similar manner.

Essential to the experiment was the determination of a manner in which to compare the disk materials. A current (resistor and inductor circuits) or voltage (capacitor circuits) yielding a probability of one ignition per thousand

<sup>4</sup>Work done by Denver Research Institute under Bureau of Mines contract H111585.

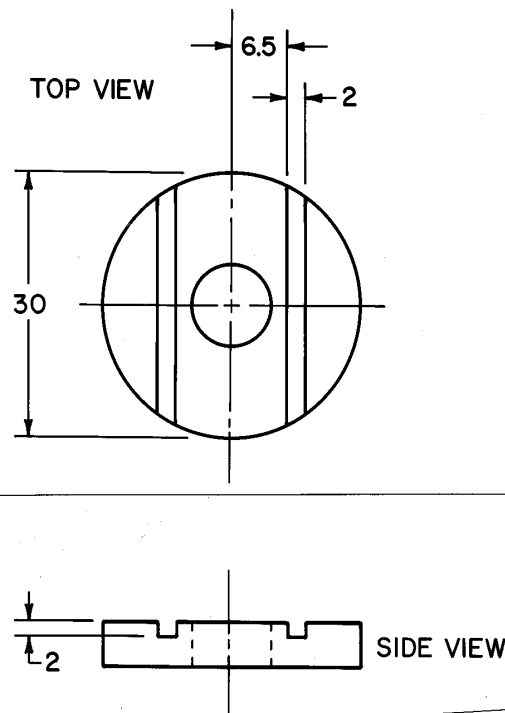

Figure 5.—Disk electrode, constructed of various materials. (All dimensions are in millimeters.)

sparks was chosen as the basis upon which to compare materials. This probability of ignition was arbitrarily chosen because (1) it is easy to generate enough data for a reasonable confidence level, (2) past research has shown that the current (voltage) versus probability data graphs are linear on log-log coordinates, and (3) results may be extrapolated to probabilities of ignition as low as  $10^{-7}$  (3). To calculate the spark sample size, equation 1 was used.

$$S = (Z^2 p_i q) / d^2, \quad (1)$$

where  $S$  = spark sample size,

$Z$  = Z score,<sup>5</sup> 2.326,

$p_i$  = target probability of ignition,  $10^{-3}$ ,

$q$  = probability of not getting an ignition, or  $1 - p_i$ ,

and  $d$  = acceptable probability of ignition error,  $5 \times 10^{-4}$ .

Thus, with a 98%-confidence level, the probability of ignition would fall between  $5 \times 10^{-4}$  and  $1.5 \times 10^{-3}$  (fig. 6). Equation 1 yields a sample size of approximately 22,000 sparks. A typical data set would then produce 22 ignitions. Whenever 22 ignitions or 22,000 sparks were accumulated, a data set was considered complete and testing was halted. For each material, at least three data points were taken.

Figure 7 illustrates the gas mixing system used in the experiment. The test gas was delivered to the breakflash apparatus explosion chamber at a rate of  $500 \text{ cm}^3/\text{min}$  and consisted of  $8.3\% \pm 0.3\%$  methane,  $20.0\%$  oxygen, and the balance nitrogen. Each gas has its own mass flowmeter and accompanying flow controller. Each flowmeter is calibrated for the particular gas and has an accuracy of  $\pm 3\%$  full scale. So that the gas concentration would remain consistent, the methane and oxygen flow rates could be set to track the nitrogen or, if necessary, be controlled manually. The methane concentration was monitored by a nondispersive infrared analyzer, which had flow rates limited to  $1.0 \pm 0.5 \text{ L}/\text{min}$ . The oxygen monitor was installed in parallel with the breakflash explosion chamber, and its flow rate was automatically limited to 100 to  $150 \text{ cm}^3/\text{min}$ . The spark test apparatus verification specified in section 8.4 of ANSI/UL 913 was performed daily to verify the integrity of the test gas. Installed on the inlet of the breakflash explosion chamber was a flame arrestor to prevent propagation of an ignition back into the gas mixing system (fig. 8). Also installed on the explosion chamber was a pressure switch. In the event of an ignition, a delay circuit triggered by the switch stopped the electrode shafts, allowing the system to purge the products of combustion for 3-1/2 min before restarting the electrode shafts.

<sup>5</sup>Z score is a statistical parameter whose value is dependent upon the level of confidence chosen; in this case, 98%.

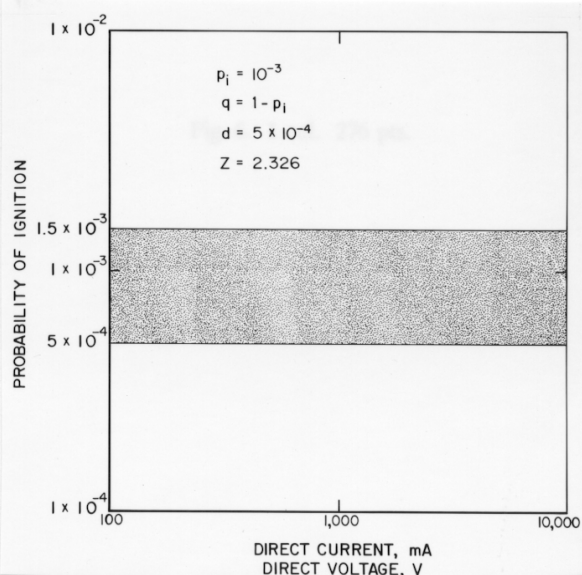

Figure 6.—Acceptable probability of ignition range of  $5 \times 10^{-4}$  to  $1.5 \times 10^{-3}$ .

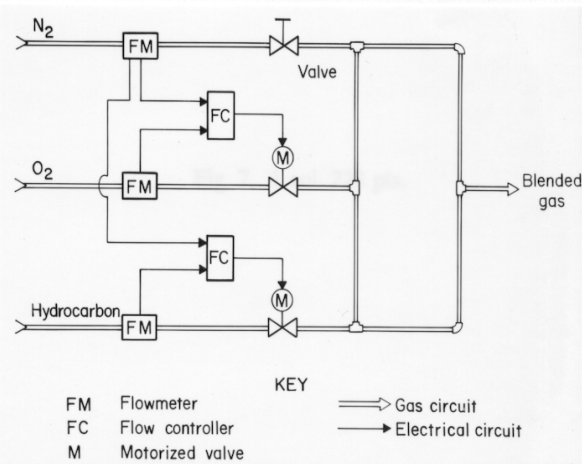

Figure 7.—Diagram of gas mixing system.

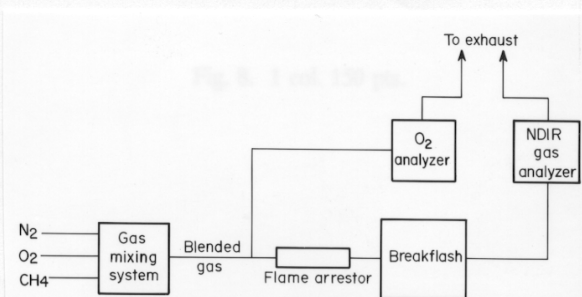

Figure 8.—Diagram of gas flow.

## METHOD OF COMPUTER ANALYSIS

A commercially available software package, RS/1, release 3, was used to analyze the test data using multiple regression techniques. Each data set contained a test current (voltage) and a corresponding probability of ignition, defined as the number of ignitions ( $N_i$ ) divided by the number of sparks ( $N_s$ ).

$$p_i = N_i/N_s \quad (2)$$

Initially, the log of the current (voltage) was plotted versus the log of the probability of ignition. A straight-line curve fit of this plot yielded an equation of the form

$$\text{Log } p_i = B(\text{log } I \text{ or } \text{log } V) + E, \quad (3)$$

where  $B$  = slope of graph,

and  $E$  = constant term.

From this, the probability of ignition can be estimated at each test current or voltage and plotted with the test results. Graphs of these data would be the logarithmically transformed current (voltage) and probability of ignition data and would have the form

$$p_i = BI^A \quad (4)$$

or

$$p_i = BV^A, \quad (5)$$

where  $p_i$  = probability of ignition,

$I$  = current, mA,

$V$  = voltage, V dc,

$B$  = slope of graph, same as in equation 3,

and  $A$  = antilog of  $E$ , as in equation 3.

Further analysis using equation 3 would generate the ignition current or ignition voltage corresponding to the target probability of one ignition per thousand sparks. By comparing these to previous Bureau research involving cadmium disks, safety factors may be assigned for each material.

## TEST RESULTS AND ANALYSIS

Resistor circuit results are included in tables 2 through 8. These results are shown graphically in figures 9 through 11. The cadmium curves shown are those of previous Bureau research (4). The graphs illustrate that the ignition currents are highly voltage dependent. Table 9 summarizes the test results. Listed in this table are exponent  $A$  and coefficient  $B$  of equation 4;  $I_c$ , the current yielding one ignition per thousand sparks, and the safety factor for each material. As shown, the safety factors vary widely among the test materials, with cadmium having the lowest ignition current at all test voltages. In general, the order of the materials from lowest to highest safety factor was consistent throughout the resistor circuit testing. This fact and the magnitudes of the safety factors illustrate that ignition current in resistor circuits is highly material dependent.

Inductor circuit test results are included in tables 2 through 8 and in figures 12 through 15. Here, the ignition currents were highly dependent upon inductance. Table 10 summarizes the results. The safety factors for inductor circuits were somewhat less than those for resistor circuit work; i.e., the influence of the material on the probability of ignition was less. Cadmium still had the lowest ignition current. The results also illustrate that as circuit inductance increased, the goodness of fit increased. Or, as the test circuit became more like a simple resistor circuit (i.e., as the circuit resistance-circuit inductance ratio increased), test results became more random or unpredictable.

Table 2.—Voltage-current versus probability of ignition for aluminum disks

|                | Direct current, mA | Probability of ignition |                      | Voltage, V dc        | Probability of ignition |
|----------------|--------------------|-------------------------|----------------------|----------------------|-------------------------|
| At 30 V dc ... | 1,803              | $3.2 \times 10^{-4}$    | At 1.2 $\mu$ F ....  | 190.0                | $4.6 \times 10^{-4}$    |
|                | 1,873              | $9.1 \times 10^{-4}$    |                      | 205.0                | $1.9 \times 10^{-3}$    |
|                | 1,973              | $8.6 \times 10^{-4}$    |                      | 220.0                | $1.1 \times 10^{-3}$    |
|                | 2,100              | $1.0 \times 10^{-3}$    |                      | 235.0                | $1.5 \times 10^{-3}$    |
|                | 2,520              | $9.8 \times 10^{-3}$    |                      |                      |                         |
| At 40 V dc ... | 950                | $4.5 \times 10^{-5}$    | At 10.3 $\mu$ F ...  | 38.4                 | $3.6 \times 10^{-4}$    |
|                | 1,080              | $1.4 \times 10^{-4}$    |                      | 40.4                 | $6.8 \times 10^{-4}$    |
|                | 1,200              | $2.1 \times 10^{-3}$    |                      | 42.4                 | $1.4 \times 10^{-3}$    |
|                | 1,360              | $5.9 \times 10^{-3}$    | 44.4                 | $4.1 \times 10^{-2}$ |                         |
|                |                    |                         |                      |                      |                         |
| At 50 V dc ... | 847                | $1.4 \times 10^{-4}$    | At 107 $\mu$ F ....  | 16.3                 | $2.3 \times 10^{-4}$    |
|                | 892                | $4.6 \times 10^{-4}$    |                      | 17.3                 | $9.4 \times 10^{-4}$    |
|                | 980                | $1.1 \times 10^{-3}$    |                      | 18.3                 | $2.3 \times 10^{-3}$    |
|                | 1,108              | $1.5 \times 10^{-3}$    | 19.3                 | $6.5 \times 10^{-2}$ |                         |
|                |                    |                         |                      |                      |                         |
| At 1 mH ....   | 900                | $1.3 \times 10^{-4}$    | At 1,310 $\mu$ F ... | 9.0                  | $1.3 \times 10^{-4}$    |
|                | 1,000              | $1.4 \times 10^{-4}$    |                      | 9.25                 | $1.3 \times 10^{-3}$    |
|                | 1,100              | $4.0 \times 10^{-4}$    |                      | 9.4                  | $3.6 \times 10^{-3}$    |
|                | 1,140              | $2.3 \times 10^{-3}$    |                      | 10.0                 | $4.4 \times 10^{-3}$    |
|                | 1,224              | $4.1 \times 10^{-3}$    |                      | 11.0                 | $1.1 \times 10^{-2}$    |
|                | 1,300              | $1.2 \times 10^{-3}$    |                      |                      |                         |
| At 10 mH ...   | 520                | $2.2 \times 10^{-4}$    |                      |                      |                         |
|                | 535                | $2.7 \times 10^{-4}$    |                      |                      |                         |
|                | 550                | $1.3 \times 10^{-3}$    |                      |                      |                         |
|                | 575                | $1.6 \times 10^{-3}$    |                      |                      |                         |
| At 100 mH ...  | 160                | $2.5 \times 10^{-4}$    |                      |                      |                         |
|                | 168                | $1.4 \times 10^{-4}$    |                      |                      |                         |
|                | 171                | $1.3 \times 10^{-3}$    |                      |                      |                         |
|                | 175                | $5.3 \times 10^{-3}$    |                      |                      |                         |
|                | 200                | $9.1 \times 10^{-2}$    |                      |                      |                         |
| At 600 mH ...  | 101                | $2.6 \times 10^{-4}$    |                      |                      |                         |
|                | 105                | $6.9 \times 10^{-4}$    |                      |                      |                         |
|                | 110                | $2.8 \times 10^{-3}$    |                      |                      |                         |
|                | 115                | $8.9 \times 10^{-3}$    |                      |                      |                         |
|                |                    |                         |                      |                      |                         |

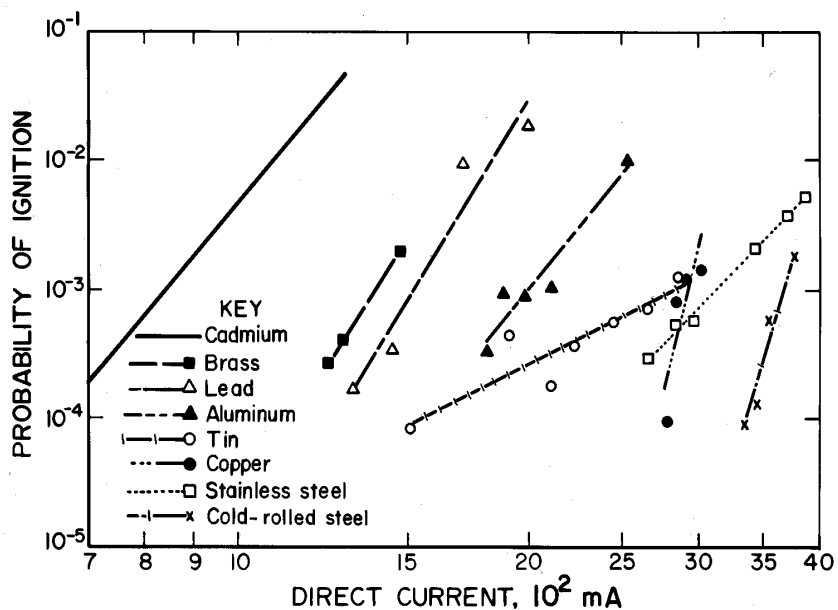

Figure 9.—Probability of ignition versus current results for 30-V dc resistor circuit.

Table 3.—Voltage-current versus probability of ignition for brass disks

| Direct current, mA |                         |                      | Voltage, V dc       |                         |                      |
|--------------------|-------------------------|----------------------|---------------------|-------------------------|----------------------|
|                    | Probability of ignition |                      |                     | Probability of ignition |                      |
| At 30 V dc ..      | 1,240                   | $2.7 \times 10^{-4}$ | At 1.2 $\mu$ F .... | 327.0                   | $9.1 \times 10^{-5}$ |
|                    | 1,285                   | $4.0 \times 10^{-4}$ |                     | 345.0                   | $4.5 \times 10^{-4}$ |
|                    | 1,473                   | $2.0 \times 10^{-3}$ |                     | 373.0                   | $2.7 \times 10^{-4}$ |
| At 40 V dc ..      | 712                     | $4.5 \times 10^{-5}$ | 400.0               | $2.9 \times 10^{-4}$    |                      |
|                    | 820                     | $6.8 \times 10^{-4}$ | 425.0               | $1.2 \times 10^{-3}$    |                      |
|                    | 907                     | $1.1 \times 10^{-3}$ | At 10.3 $\mu$ F ... | 78.0                    | $7.2 \times 10^{-4}$ |
|                    | 1,110                   | $1.1 \times 10^{-3}$ | 85.0                | $1.2 \times 10^{-3}$    |                      |
| At 50 V dc ..      | 561                     | $2.7 \times 10^{-4}$ | At 107 $\mu$ F .... | 90.0                    | $1.5 \times 10^{-3}$ |
|                    | 604                     | $4.6 \times 10^{-4}$ | 25.0                | $5.1 \times 10^{-4}$    |                      |
|                    | 710                     | $1.2 \times 10^{-3}$ | 27.0                | $3.6 \times 10^{-4}$    |                      |
|                    | 910                     | $2.0 \times 10^{-2}$ | 28.5                | $2.0 \times 10^{-2}$    |                      |
| At 1 mH ....       | 900                     | $4.6 \times 10^{-4}$ | At 1,310 $\mu$ F .. | 32.0                    | $1.2 \times 10^{-2}$ |
|                    | 950                     | $1.2 \times 10^{-3}$ | 15.8                | $1.4 \times 10^{-4}$    |                      |
|                    | 1,001                   | $1.8 \times 10^{-3}$ | 16.5                | $9.1 \times 10^{-4}$    |                      |
|                    | 1,306                   | $1.6 \times 10^{-2}$ | 17.0                | $8.9 \times 10^{-4}$    |                      |
| At 10 mH ...       | 425                     | $1.3 \times 10^{-4}$ | 18.5                | $6.8 \times 10^{-3}$    |                      |
|                    | 433                     | $6.7 \times 10^{-4}$ |                     |                         |                      |
|                    | 440                     | $1.3 \times 10^{-3}$ |                     |                         |                      |
|                    | 450                     | $1.2 \times 10^{-3}$ |                     |                         |                      |
| At 100 mH ..       | 460                     | $3.4 \times 10^{-2}$ |                     |                         |                      |
|                    | 137                     | $1.8 \times 10^{-4}$ |                     |                         |                      |
|                    | 145                     | $1.9 \times 10^{-3}$ |                     |                         |                      |
|                    | 150                     | $3.2 \times 10^{-3}$ |                     |                         |                      |
| At 600 mH ..       | 200                     | $1.3 \times 10^{-1}$ |                     |                         |                      |
|                    | 95                      | $9.1 \times 10^{-5}$ |                     |                         |                      |
|                    | 100                     | $1.4 \times 10^{-3}$ |                     |                         |                      |
|                    | 105                     | $4.6 \times 10^{-3}$ |                     |                         |                      |
|                    | 120                     | $1.1 \times 10^{-1}$ |                     |                         |                      |

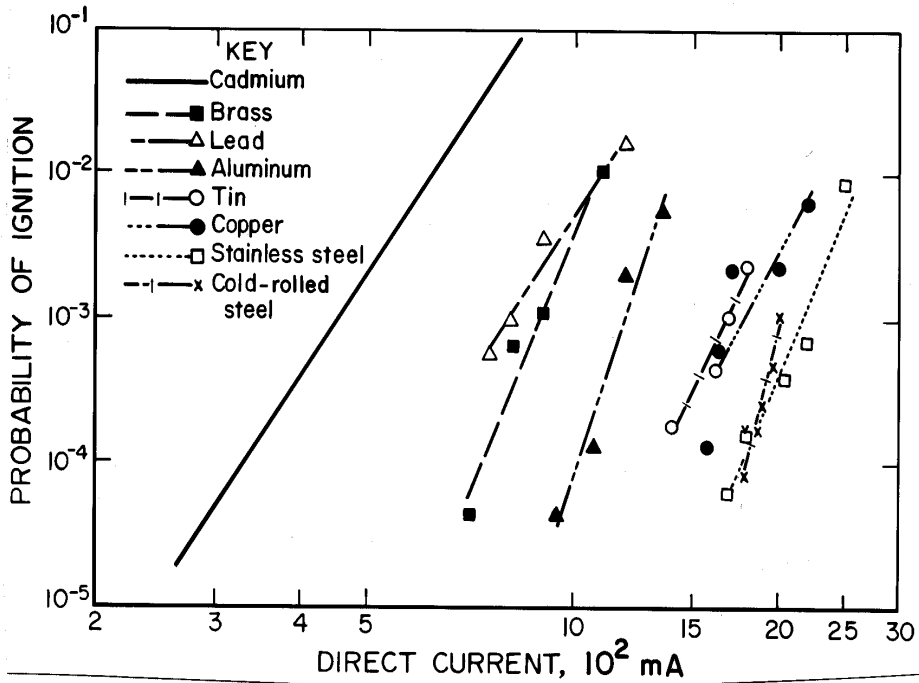

Figure 10.—Probability of ignition versus current results for 40-V dc resistor circuit.

Table 4.—Voltage-current versus probability of Ignition for cold-rolled steel disks

|               | Direct current, mA   | Probability of Ignition |                     | Voltage, V dc        | Probability of Ignition |
|---------------|----------------------|-------------------------|---------------------|----------------------|-------------------------|
| At 30 V dc .. | 3,330                | $8.9 \times 10^{-5}$    | At 1.2 $\mu$ F .... | 327.0                | $9.1 \times 10^{-5}$    |
|               | 3,450                | $1.3 \times 10^{-4}$    |                     | 345.0                | $4.5 \times 10^{-4}$    |
|               | 3,550                | $5.9 \times 10^{-4}$    |                     | 373.0                | $2.7 \times 10^{-4}$    |
| At 40 V dc .. | 3,780                | $1.8 \times 10^{-3}$    | 400.0               | $2.9 \times 10^{-4}$ |                         |
|               | 1,785                | $8.6 \times 10^{-5}$    | 425.0               | $1.2 \times 10^{-3}$ |                         |
|               | 1,800                | $1.8 \times 10^{-4}$    | At 10.3 $\mu$ F ... | 78.0                 | $7.2 \times 10^{-4}$    |
|               | 1,877                | $1.8 \times 10^{-4}$    |                     | 85.0                 | $1.2 \times 10^{-3}$    |
|               | 1,900                | $2.7 \times 10^{-4}$    |                     | 90.0                 | $1.5 \times 10^{-3}$    |
| At 50 V dc .. | 1,966                | $5.0 \times 10^{-4}$    | At 107 $\mu$ F .... | 25.0                 | $5.1 \times 10^{-4}$    |
|               | 2,000                | $1.1 \times 10^{-3}$    |                     | 27.0                 | $3.6 \times 10^{-4}$    |
|               | 1,200                | $9.0 \times 10^{-5}$    |                     | 28.5                 | $2.0 \times 10^{-2}$    |
|               | 1,300                | $1.0 \times 10^{-3}$    | At 1,310 $\mu$ F .. | 32.0                 | $1.2 \times 10^{-2}$    |
|               | 1,400                | $2.2 \times 10^{-3}$    |                     | 15.8                 | $1.4 \times 10^{-4}$    |
| 1,500         | $8.4 \times 10^{-3}$ | 16.5                    |                     | $9.1 \times 10^{-4}$ |                         |
| At 1 mH ....  | 1,410                | $7.3 \times 10^{-4}$    | 17.0                | $8.9 \times 10^{-4}$ |                         |
|               | 1,436                | $5.6 \times 10^{-3}$    | 18.5                | $6.8 \times 10^{-3}$ |                         |
|               | 1,450                | $3.5 \times 10^{-2}$    |                     |                      |                         |
|               | 1,474                | $4.0 \times 10^{-2}$    |                     |                      |                         |
| At 10 mH ...  | 540                  | $1.8 \times 10^{-4}$    |                     |                      |                         |
|               | 545                  | $4.1 \times 10^{-4}$    |                     |                      |                         |
|               | 550                  | $9.5 \times 10^{-4}$    |                     |                      |                         |
|               | 600                  | $3.8 \times 10^{-2}$    |                     |                      |                         |
| At 100 mH ..  | 164                  | $7.1 \times 10^{-4}$    |                     |                      |                         |
|               | 169                  | $1.5 \times 10^{-3}$    |                     |                      |                         |
|               | 174.5                | $1.4 \times 10^{-3}$    |                     |                      |                         |
|               | 180.5                | $2.3 \times 10^{-3}$    |                     |                      |                         |
| At 600 mH ..  | 108                  | $3.2 \times 10^{-4}$    |                     |                      |                         |
|               | 110.5                | $3.2 \times 10^{-4}$    |                     |                      |                         |
|               | 112.5                | $2.7 \times 10^{-3}$    |                     |                      |                         |
|               | 115                  | $6.3 \times 10^{-3}$    |                     |                      |                         |

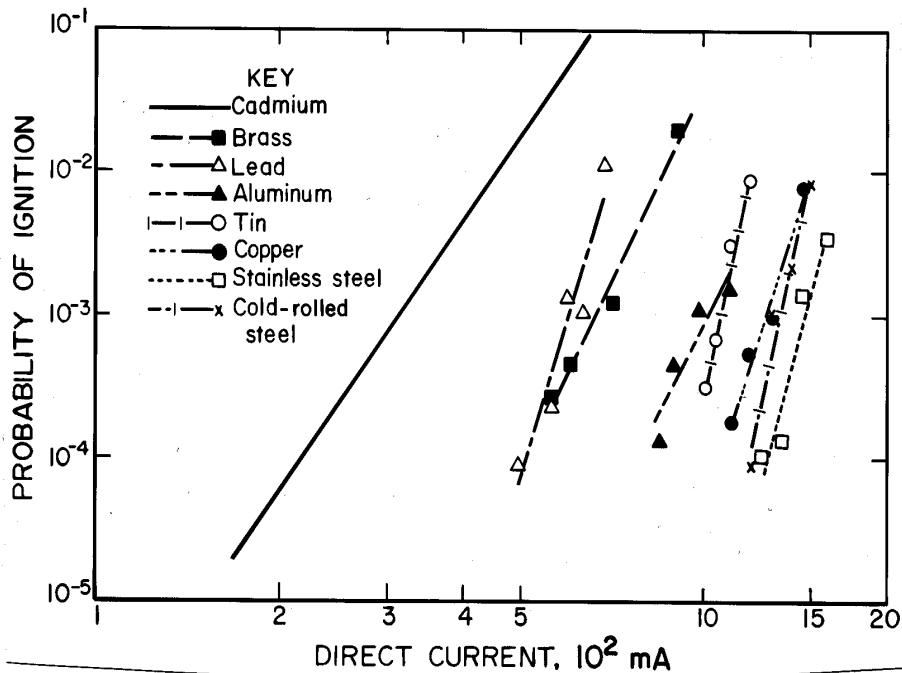

Figure 11.—Probability of Ignition versus current results for 50-V dc resistor circuit.

Table 5.—Voltage-current versus probability of ignition for copper disks

|                | Direct current, mA | Probability of ignition |                      | Voltage, V dc        | Probability of Ignition |
|----------------|--------------------|-------------------------|----------------------|----------------------|-------------------------|
| At 30 V dc ... | 2,770              | $9.1 \times 10^{-5}$    | At 1.2 $\mu$ F ....  | 220.0                | $3.2 \times 10^{-4}$    |
|                | 2,830              | $7.7 \times 10^{-4}$    |                      | 226.0                | $9.1 \times 10^{-5}$    |
|                | 2,900              | $1.2 \times 10^{-3}$    |                      | 233.0                | $5.4 \times 10^{-4}$    |
|                | 3,000              | $1.4 \times 10^{-3}$    |                      | 250.0                | $2.7 \times 10^{-4}$    |
| At 40 V dc ... | 1,580              | $1.4 \times 10^{-4}$    | 275.0                | $2.7 \times 10^{-4}$ |                         |
|                | 1,640              | $6.4 \times 10^{-4}$    | 310.0                | $1.1 \times 10^{-3}$ |                         |
|                | 1,709              | $2.3 \times 10^{-3}$    | At 10.3 $\mu$ F ...  | 43.0                 | $9.1 \times 10^{-5}$    |
|                | 2,000              | $2.4 \times 10^{-3}$    |                      | 45.0                 | $5.9 \times 10^{-4}$    |
|                | 2,200              | $6.5 \times 10^{-3}$    |                      | 47.5                 | $9.3 \times 10^{-4}$    |
| At 50 V dc ... | 1,110              | $1.8 \times 10^{-4}$    | At 107 $\mu$ F ....  | 50.0                 | $4.7 \times 10^{-3}$    |
|                | 1,191              | $5.5 \times 10^{-4}$    |                      | 20.3                 | $3.1 \times 10^{-4}$    |
|                | 1,305              | $9.7 \times 10^{-4}$    | 20.5                 | $9.0 \times 10^{-4}$ |                         |
|                | 1,462              | $7.8 \times 10^{-3}$    | 21.0                 | $6.3 \times 10^{-4}$ |                         |
| At 1 mH ....   | 1,000              | $5.0 \times 10^{-4}$    | At 1,310 $\mu$ F ... | 21.5                 | $8.3 \times 10^{-3}$    |
|                | 1,025              | $5.4 \times 10^{-4}$    |                      | 22.0                 | $1.7 \times 10^{-2}$    |
|                | 1,100              | $1.4 \times 10^{-3}$    |                      | 13.2                 | $2.1 \times 10^{-3}$    |
|                | 1,195              | $2.6 \times 10^{-3}$    |                      | 13.4                 | $5.0 \times 10^{-4}$    |
|                | 1,200              | $2.7 \times 10^{-3}$    |                      | 13.8                 | $1.0 \times 10^{-3}$    |
| At 10 mH ...   | 500                | $1.8 \times 10^{-4}$    | 14.3                 | $1.7 \times 10^{-3}$ |                         |
|                | 525                | $7.2 \times 10^{-4}$    | 14.8                 | $3.3 \times 10^{-3}$ |                         |
|                | 550                | $9.2 \times 10^{-4}$    | 15.3                 | $1.3 \times 10^{-2}$ |                         |
|                | 600                | $1.9 \times 10^{-2}$    |                      |                      |                         |
| At 100 mH ..   | 155                | $1.3 \times 10^{-4}$    |                      |                      |                         |
|                | 159                | $1.6 \times 10^{-4}$    |                      |                      |                         |
|                | 163                | $1.5 \times 10^{-3}$    |                      |                      |                         |
|                | 166                | $3.8 \times 10^{-3}$    |                      |                      |                         |
|                | 170                | $5.8 \times 10^{-3}$    |                      |                      |                         |
| At 600 mH ..   | 102.5              | $5.9 \times 10^{-4}$    |                      |                      |                         |
|                | 105                | $7.7 \times 10^{-4}$    |                      |                      |                         |
|                | 110                | $5.3 \times 10^{-3}$    |                      |                      |                         |
|                | 130                | $1.6 \times 10^{-1}$    |                      |                      |                         |

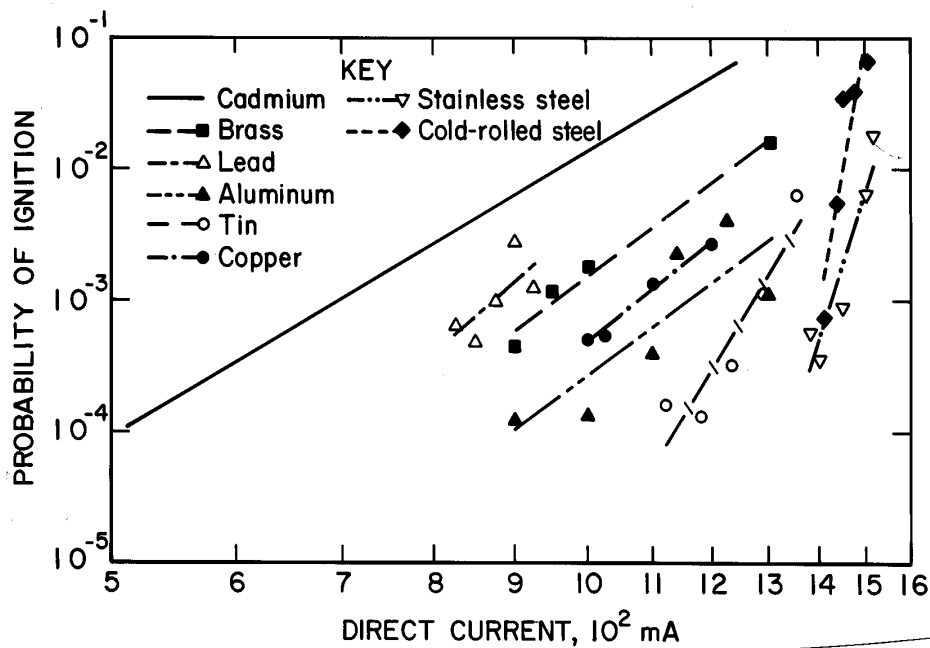

Figure 12.—Probability of ignition versus current results for 1-mH inductor circuit.

Table 6.—Voltage-current versus probability of ignition for lead disks

| Direct current, mA |       |                         | Voltage, V dc       |                      |                         |
|--------------------|-------|-------------------------|---------------------|----------------------|-------------------------|
|                    |       | Probability of Ignition |                     |                      | Probability of Ignition |
| At 30 V dc ..      | 1,317 | $2.7 \times 10^{-4}$    | At 1.2 $\mu$ F .... | 250.0                | $1.4 \times 10^{-4}$    |
|                    | 1,445 | $5.1 \times 10^{-4}$    |                     | 275.0                | $8.5 \times 10^{-5}$    |
|                    | 1,710 | $5.5 \times 10^{-4}$    |                     | 283.0                | $4.1 \times 10^{-4}$    |
|                    | 2,000 | $2.0 \times 10^{-3}$    |                     | 290.0                | $7.0 \times 10^{-4}$    |
| At 40 V dc ..      | 755   | $5.9 \times 10^{-5}$    | At 10.3 $\mu$ F ... | 295.0                | $2.2 \times 10^{-3}$    |
|                    | 814   | $1.0 \times 10^{-3}$    |                     | 300.0                | $3.5 \times 10^{-3}$    |
|                    | 906   | $3.7 \times 10^{-3}$    |                     | 45.0                 | $5.0 \times 10^{-4}$    |
|                    | 1,200 | $1.7 \times 10^{-2}$    |                     | 48.0                 | $5.8 \times 10^{-4}$    |
| At 50 V dc ..      | 496   | $9.1 \times 10^{-5}$    | At 107 $\mu$ F .... | 51.0                 | $8.2 \times 10^{-4}$    |
|                    | 562   | $2.3 \times 10^{-4}$    |                     | 58.0                 | $1.8 \times 10^{-3}$    |
|                    | 596   | $1.4 \times 10^{-3}$    |                     | 20.0                 | $1.7 \times 10^{-4}$    |
|                    | 632   | $1.1 \times 10^{-3}$    |                     | 21.0                 | $6.2 \times 10^{-4}$    |
| At 1 mH ....       | 686   | $1.1 \times 10^{-2}$    | At 1,310 $\mu$ F .. | 22.0                 | $1.1 \times 10^{-3}$    |
|                    | 825   | $6.6 \times 10^{-4}$    |                     | 23.0                 | $2.5 \times 10^{-3}$    |
|                    | 850   | $4.9 \times 10^{-4}$    |                     | 25.0                 | $3.7 \times 10^{-2}$    |
|                    | 875   | $1.0 \times 10^{-3}$    |                     | 14.0                 | $9.1 \times 10^{-5}$    |
| At 10 mH ...       | 900   | $2.9 \times 10^{-3}$    | 14.8                | $4.1 \times 10^{-4}$ |                         |
|                    | 925   | $1.3 \times 10^{-3}$    | 15.0                | $8.2 \times 10^{-4}$ |                         |
|                    | 412   | $2.7 \times 10^{-4}$    | 15.2                | $1.3 \times 10^{-3}$ |                         |
|                    | 425   | $6.4 \times 10^{-4}$    | 15.5                | $5.1 \times 10^{-3}$ |                         |
| At 100 mH ..       | 450   | $2.8 \times 10^{-3}$    |                     |                      |                         |
|                    | 500   | $1.9 \times 10^{-2}$    |                     |                      |                         |
|                    | 130   | $1.6 \times 10^{-4}$    |                     |                      |                         |
|                    | 133   | $4.1 \times 10^{-4}$    |                     |                      |                         |
| At 600 mH ..       | 137   | $1.2 \times 10^{-3}$    |                     |                      |                         |
|                    | 140   | $2.2 \times 10^{-3}$    |                     |                      |                         |
|                    | 80    | $1.4 \times 10^{-4}$    |                     |                      |                         |
|                    | 83    | $5.5 \times 10^{-4}$    |                     |                      |                         |
|                    | 87    | $1.4 \times 10^{-3}$    |                     |                      |                         |
|                    | 90    | $3.8 \times 10^{-3}$    |                     |                      |                         |

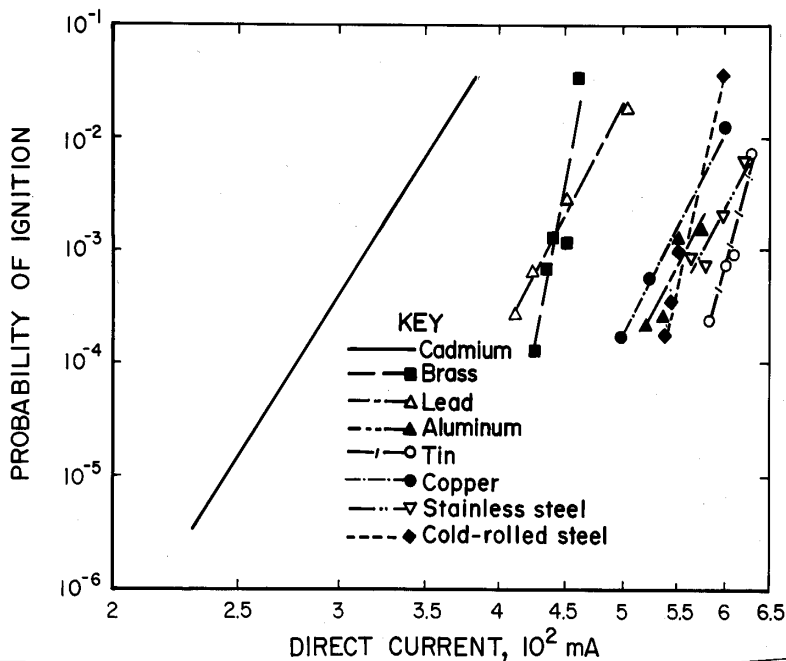

Figure 13.—Probability of ignition versus current results for 10-mH inductor circuit.



Table 7.—Voltage-current versus probability of ignition for stainless steel disks

|                | Direct current, mA | Probability of Ignition |                      | Voltage, V dc        | Probability of ignition |                      |
|----------------|--------------------|-------------------------|----------------------|----------------------|-------------------------|----------------------|
| At 30 V dc ... | 2,640              | $2.7 \times 10^{-4}$    | At 1.2 $\mu$ F ....  | 355.0                | $9.9 \times 10^{-5}$    |                      |
|                | 2,820              | $5.1 \times 10^{-4}$    |                      | 366.0                | $1.4 \times 10^{-4}$    |                      |
|                | 2,950              | $5.5 \times 10^{-4}$    |                      | 445.0                | $1.9 \times 10^{-3}$    |                      |
|                | 3,410              | $2.0 \times 10^{-3}$    |                      | At 10.3 $\mu$ F ...  | 70.0                    | $9.1 \times 10^{-5}$ |
|                | 3,700              | $3.7 \times 10^{-3}$    |                      | 80.0                 | $4.5 \times 10^{-5}$    |                      |
| At 40 V dc ... | 3,860              | $5.1 \times 10^{-3}$    | 84.5                 | $1.8 \times 10^{-4}$ |                         |                      |
|                | 1,696              | $6.6 \times 10^{-5}$    | 94.0                 | $3.7 \times 10^{-3}$ |                         |                      |
|                | 1,800              | $1.7 \times 10^{-4}$    | At 107 $\mu$ F ....  | 26.0                 | $1.8 \times 10^{-4}$    |                      |
|                | 1,900              | $2.7 \times 10^{-4}$    | 27.0                 | $3.6 \times 10^{-4}$ |                         |                      |
|                | 2,050              | $4.1 \times 10^{-4}$    | 28.0                 | $6.1 \times 10^{-4}$ |                         |                      |
| At 50 V dc ... | 2,200              | $7.2 \times 10^{-4}$    | 30.0                 | $6.0 \times 10^{-3}$ |                         |                      |
|                | 2,500              | $9.2 \times 10^{-3}$    | At 1,310 $\mu$ F ..  | 15.0                 | $1.7 \times 10^{-4}$    |                      |
|                | 1,250              | $1.1 \times 10^{-4}$    | 15.5                 | $5.0 \times 10^{-4}$ |                         |                      |
|                | 1,350              | $1.3 \times 10^{-4}$    | 16.0                 | $1.9 \times 10^{-3}$ |                         |                      |
|                | 1,460              | $1.4 \times 10^{-3}$    | 18.0                 | $5.3 \times 10^{-3}$ |                         |                      |
| At 1 mH ....   | 1,598              | $3.5 \times 10^{-3}$    |                      |                      |                         |                      |
|                | 1,300              | $5.7 \times 10^{-4}$    |                      |                      |                         |                      |
|                | 1,400              | $3.5 \times 10^{-4}$    |                      |                      |                         |                      |
|                | 1,450              | $8.6 \times 10^{-4}$    |                      |                      |                         |                      |
|                | 1,500              | $6.3 \times 10^{-3}$    |                      |                      |                         |                      |
| At 10 mH ...   | 1,516              | $1.8 \times 10^{-2}$    |                      |                      |                         |                      |
|                | 565                | $9.1 \times 10^{-4}$    |                      |                      |                         |                      |
|                | 580                | $7.7 \times 10^{-4}$    |                      |                      |                         |                      |
|                | 600                | $2.5 \times 10^{-3}$    |                      |                      |                         |                      |
|                | 620                | $6.1 \times 10^{-3}$    |                      |                      |                         |                      |
| At 100 mH ...  | 175                | $5.5 \times 10^{-4}$    |                      |                      |                         |                      |
|                | 180                | $6.3 \times 10^{-4}$    |                      |                      |                         |                      |
|                | 185                | $1.2 \times 10^{-3}$    |                      |                      |                         |                      |
|                | 190                | $7.0 \times 10^{-3}$    |                      |                      |                         |                      |
|                | At 600 mH ...      | 110                     | $7.2 \times 10^{-5}$ |                      |                         |                      |
| 112.5          |                    | $9.6 \times 10^{-4}$    |                      |                      |                         |                      |
| 115            |                    | $4.4 \times 10^{-3}$    |                      |                      |                         |                      |
|                |                    |                         |                      |                      |                         |                      |
| 120            |                    | $3.0 \times 10^{-2}$    |                      |                      |                         |                      |

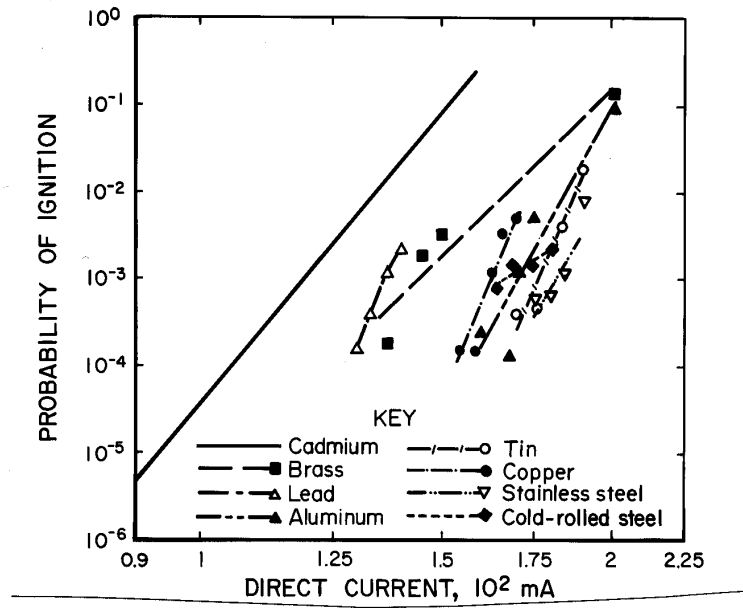

Figure 14.—Probability of ignition versus current results for 100-mH inductor circuit.

Table 8.—Voltage-current versus probability of ignition for tin disks

| Direct current, mA |       | Probability of ignition | Voltage, V dc        |       | Probability of ignition |
|--------------------|-------|-------------------------|----------------------|-------|-------------------------|
| At 30 V dc ...     | 1,500 | $8.4 \times 10^{-5}$    | At 1.2 $\mu$ F ...   | 220.0 | $2.2 \times 10^{-4}$    |
|                    | 1,912 | $4.5 \times 10^{-4}$    |                      | 260.0 | $2.3 \times 10^{-4}$    |
|                    | 2,110 | $1.8 \times 10^{-4}$    |                      | 290.0 | $1.8 \times 10^{-4}$    |
|                    | 2,230 | $3.6 \times 10^{-4}$    |                      | 300.0 | $1.1 \times 10^{-3}$    |
|                    | 2,450 | $5.7 \times 10^{-4}$    |                      | 310.0 | $1.2 \times 10^{-3}$    |
|                    | 2,660 | $7.3 \times 10^{-4}$    |                      | 330.0 | $6.6 \times 10^{-3}$    |
| At 40 V dc ...     | 2,860 | $1.3 \times 10^{-3}$    | At 10.3 $\mu$ F ...  | 48.5  | $2.7 \times 10^{-4}$    |
|                    | 1,400 | $1.9 \times 10^{-4}$    |                      | 52.5  | $4.5 \times 10^{-4}$    |
|                    | 1,620 | $4.7 \times 10^{-4}$    |                      | 56.5  | $4.1 \times 10^{-4}$    |
|                    | 1,700 | $1.1 \times 10^{-3}$    |                      | 60.5  | $8.8 \times 10^{-4}$    |
| At 50 V dc ...     | 1,792 | $2.4 \times 10^{-3}$    | At 107 $\mu$ F ...   | 65.5  | $3.4 \times 10^{-3}$    |
|                    | 1,006 | $3.2 \times 10^{-4}$    |                      | 70.5  | $8.6 \times 10^{-3}$    |
|                    | 1,050 | $7.0 \times 10^{-4}$    |                      | 21.6  | $7.4 \times 10^{-4}$    |
|                    | 1,160 | $3.1 \times 10^{-3}$    |                      | 21.8  | $1.1 \times 10^{-3}$    |
| At 1 mH ...        | 1,200 | $9.0 \times 10^{-3}$    | At 1,310 $\mu$ F ... | 22.1  | $7.7 \times 10^{-4}$    |
|                    | 1,120 | $1.6 \times 10^{-4}$    |                      | 23.1  | $1.2 \times 10^{-2}$    |
|                    | 1,180 | $1.3 \times 10^{-4}$    |                      | 23.6  | $5.7 \times 10^{-3}$    |
|                    | 1,233 | $3.2 \times 10^{-4}$    |                      | 13.35 | $1.8 \times 10^{-4}$    |
|                    | 1,290 | $1.1 \times 10^{-3}$    |                      | 13.5  | $3.6 \times 10^{-4}$    |
|                    | 1,356 | $6.4 \times 10^{-3}$    |                      | 13.65 | $1.5 \times 10^{-3}$    |
| At 10 mH ...       | 582   | $2.5 \times 10^{-4}$    |                      | 14.0  | $2.8 \times 10^{-3}$    |
|                    | 600   | $7.5 \times 10^{-4}$    |                      |       |                         |
|                    | 607   | $9.3 \times 10^{-4}$    |                      |       |                         |
|                    | 627   | $7.3 \times 10^{-3}$    |                      |       |                         |
| At 100 mH ...      | 170   | $4.0 \times 10^{-4}$    |                      |       |                         |
|                    | 176   | $4.7 \times 10^{-4}$    |                      |       |                         |
|                    | 183.5 | $4.0 \times 10^{-3}$    |                      |       |                         |
|                    | 190   | $1.8 \times 10^{-2}$    |                      |       |                         |
| At 600 mH ...      | 111   | $3.0 \times 10^{-4}$    |                      |       |                         |
|                    | 112.5 | $9.9 \times 10^{-4}$    |                      |       |                         |
|                    | 115   | $1.0 \times 10^{-3}$    |                      |       |                         |
|                    | 130   | $6.4 \times 10^{-2}$    |                      |       |                         |

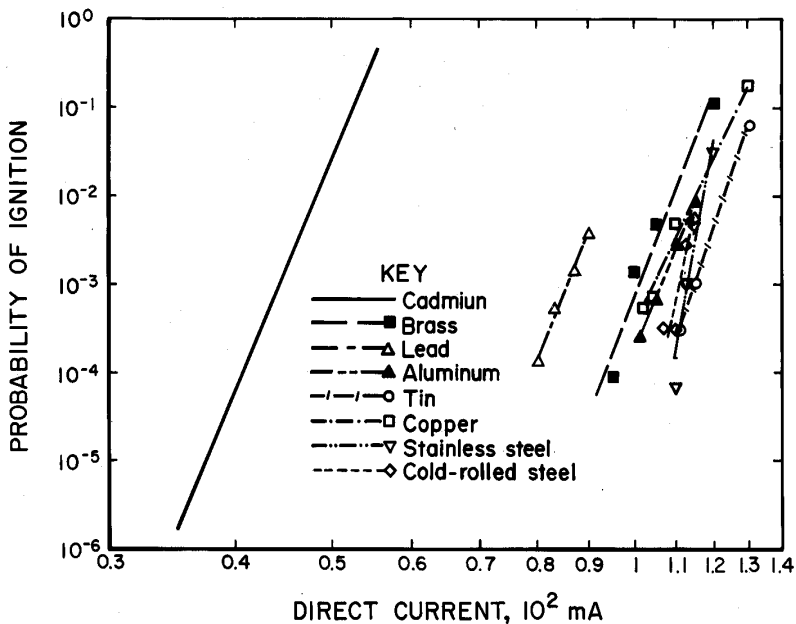

Figure 15.—Probability of ignition versus current results for 600-mH inductor circuit.

Table 9.—Safety factors and ignition currents for resistor circuits

| Disk material     | A      | B                        | $I_0$ , mA | Safety factor |
|-------------------|--------|--------------------------|------------|---------------|
| At 30 V dc:       |        |                          |            |               |
| Cadmium           | 9.063  | $3.159 \times 10^{-30}$  | 839        | 1.00          |
| Brass             | 11.705 | $1.649 \times 10^{-40}$  | 1,388      | 1.65          |
| Lead              | 12.321 | $6.237 \times 10^{-43}$  | 1,520      | 1.81          |
| Aluminum          | 9.197  | $4.375 \times 10^{-34}$  | 1,999      | 2.38          |
| Tin               | 3.798  | $7.812 \times 10^{-17}$  | 2,828      | 3.37          |
| Copper            | 30.503 | $1.857 \times 10^{-109}$ | 2,926      | 3.49          |
| Stainless steel   | 7.712  | $1.116 \times 10^{-30}$  | 3,125      | 3.73          |
| Cold-rolled steel | 25.282 | $7.114 \times 10^{-64}$  | 3,679      | 4.39          |
| At 40 V dc:       |        |                          |            |               |
| Cadmium           | 7.266  | $4.997 \times 10^{-23}$  | 453        | 1.00          |
| Lead              | 7.306  | $6.256 \times 10^{-25}$  | 798        | 1.76          |
| Brass             | 11.818 | $1.322 \times 10^{-38}$  | 894        | 1.97          |
| Aluminum          | 14.573 | $1.545 \times 10^{-48}$  | 1,189      | 2.63          |
| Tin               | 10.071 | $3.287 \times 10^{-36}$  | 1,680      | 3.71          |
| Copper            | 9.028  | $4.852 \times 10^{-33}$  | 1,767      | 3.90          |
| Cold-rolled steel | 18.429 | $1.169 \times 10^{-64}$  | 2,024      | 4.47          |
| Stainless steel   | 11.562 | $2.936 \times 10^{-42}$  | 2,150      | 4.75          |
| At 50 V dc:       |        |                          |            |               |
| Cadmium           | 6.217  | $2.969 \times 10^{-19}$  | 314        | 1.00          |
| Lead              | 14.388 | $1.079 \times 10^{-43}$  | 599        | 1.91          |
| Brass             | 8.897  | $7.854 \times 10^{-29}$  | 663        | 2.11          |
| Aluminum          | 8.435  | $4.281 \times 10^{-29}$  | 1,017      | 3.24          |
| Tin               | 19.465 | $1.226 \times 10^{-62}$  | 1,063      | 3.39          |
| Copper            | 13.033 | $3.627 \times 10^{-44}$  | 1,267      | 4.04          |
| Cold-rolled steel | 19.416 | $2.051 \times 10^{-64}$  | 1,336      | 4.25          |
| Stainless steel   | 15.786 | $1.007 \times 10^{-33}$  | 1,470      | 4.68          |

Capacitor circuit results are included in tables 2 through 8 and presented graphically in figures 16 through 19. The safety factors listed in table 11 show that typically the margin of safety attained by using materials other than cadmium decreases as the circuit capacitance increases. Surprisingly, aluminum disks produced lower ignition voltages than cadmium at 107 and 1,310  $\mu$ F. The surprising results at 1,310  $\mu$ F prompted testing using a cadmium disk electrode. Test voltages of 9.0, 9.4, and 11.0 V dc used in aluminum testing were repeated with the cadmium disk. Using 22,000-spark data sets, no ignitions were observed in any of the tests. A retest of aluminum disks at 9.0, 9.4, and 11.0 V dc resulted in ignitions in sufficient quantities to verify the previous aluminum results. Testing at 107  $\mu$ F illustrates only negligible differences between copper, cadmium brass, tin, and lead ignition voltages. Their ignition voltages were clustered around 21.0 V dc.

Some of these unusual results may be attributed to experimental error inherent in the testing. As an example, for a data set of 22,000 sparks, if the probability of ignition is  $10^{-3} \pm 5 \times 10^{-4}$ , the data set will produce  $22 \pm 11$  ignitions. The large number of tests required to complete the project effectively prohibited testing at lower probability levels or narrower error ranges because of the large amounts of time involved. If the acceptable error range is still

Table 10.—Safety factors and ignition currents for inductor circuits

| Disk material     | A      | B                        | $I_0$ , mA | Safety factor |
|-------------------|--------|--------------------------|------------|---------------|
| At 1 mH:          |        |                          |            |               |
| Cadmium           | 6.189  | $2.410 \times 10^{-21}$  | 702        | 1.00          |
| Lead              | 10.792 | $1.845 \times 10^{-35}$  | 872        | 1.24          |
| Brass             | 9.036  | $1.211 \times 10^{-30}$  | 953        | 1.36          |
| Copper            | 9.714  | $3.419 \times 10^{-33}$  | 1,079      | 1.54          |
| Aluminum          | 9.084  | $1.497 \times 10^{-31}$  | 1,157      | 1.65          |
| Tin               | 20.136 | $3.129 \times 10^{-66}$  | 1,271      | 1.81          |
| Cold-rolled steel | 68.627 | $1.170 \times 10^{-219}$ | 1,401      | 2.00          |
| Stainless steel   | 38.007 | $7.318 \times 10^{-123}$ | 1,426      | 2.03          |
| At 10 mH:         |        |                          |            |               |
| Cadmium           | 18.082 | $6.687 \times 10^{-49}$  | 315        | 1.00          |
| Lead              | 21.753 | $4.146 \times 10^{-61}$  | 434        | 1.38          |
| Brass             | 59.951 | $3.342 \times 10^{-167}$ | 439        | 1.39          |
| Copper            | 24.760 | $2.420 \times 10^{-71}$  | 538        | 1.71          |
| Cold-rolled steel | 48.034 | $1.468 \times 10^{-135}$ | 555        | 1.76          |
| Aluminum          | 21.886 | $7.820 \times 10^{-64}$  | 558        | 1.77          |
| Stainless steel   | 22.439 | $1.166 \times 10^{-65}$  | 575        | 1.83          |
| Tin               | 45.153 | $2.880 \times 10^{-129}$ | 603        | 1.91          |
| At 100 mH:        |        |                          |            |               |
| Cadmium           | 19.310 | $9.253 \times 10^{-44}$  | 118        | 1.00          |
| Lead              | 35.404 | $2.493 \times 10^{-79}$  | 137        | 1.16          |
| Brass             | 15.652 | $1.593 \times 10^{-37}$  | 144        | 1.22          |
| Copper            | 47.911 | $1.041 \times 10^{-109}$ | 163        | 1.38          |
| Cold-rolled steel | 10.603 | $2.676 \times 10^{-27}$  | 167        | 1.42          |
| Aluminum          | 29.077 | $1.243 \times 10^{-68}$  | 171        | 1.45          |
| Tin               | 36.299 | $2.766 \times 10^{-85}$  | 177        | 1.50          |
| Stainless steel   | 30.138 | $9.366 \times 10^{-72}$  | 181        | 1.53          |
| At 600 mH:        |        |                          |            |               |
| Cadmium           | 27.416 | $7.825 \times 10^{-49}$  | 44         | 1.00          |
| Lead              | 27.346 | $1.420 \times 10^{-56}$  | 86         | 1.96          |
| Brass             | 28.730 | $2.692 \times 10^{-61}$  | 101        | 2.30          |
| Aluminum          | 27.495 | $1.978 \times 10^{-59}$  | 106        | 2.41          |
| Cold-rolled steel | 52.849 | $7.375 \times 10^{-112}$ | 111        | 2.52          |
| Copper            | 23.806 | $8.252 \times 10^{-52}$  | 113        | 2.57          |
| Stainless steel   | 66.988 | $2.382 \times 10^{-141}$ | 113        | 2.57          |
| Tin               | 32.120 | $7.965 \times 10^{-70}$  | 114        | 2.59          |

considered to be 50% of the target probability of ignition, then decreasing the target probability of ignition by an order of magnitude increases the spark sample size by a factor of 10, or from 22,000 sparks to 220,000 sparks. Cutting the acceptable error range in half would increase the sample size by a factor of 4 from 22,000 sparks to 88,000 sparks.

Some of the test results produced curves with unusually low slopes, such as tin at 30-V dc resistor circuit testing. This also may be attributed to the large acceptable error range. Adjusting the probabilities of ignition at the test currents (voltages) by 50% could drastically alter the slope of the graph. Continuing research includes extrapolating data that produced unusually low slopes, such as tin, 30 V dc, to find a current (voltage) yielding a probability of  $10^{-5}$  and then testing it to verify that it falls reasonably close to the extrapolated curve.

Table 11.—Safety factors and ignition voltages for capacitor circuits

| Disk material         | A      | B                       | $V_{ci}$<br>V dc | Safety factor |
|-----------------------|--------|-------------------------|------------------|---------------|
| At 1.2 $\mu$ F:       |        |                         |                  |               |
| Cadmium . . . . .     | 7.481  | $2.877 \times 10^{-20}$ | 162.6            | 1.00          |
| Aluminum . . . . .    | 4.446  | $4.977 \times 10^{-14}$ | 207.7            | 1.28          |
| Brass . . . . .       | 12.665 | $3.556 \times 10^{-34}$ | 253.6            | 1.56          |
| Lead . . . . .        | 18.249 | $1.067 \times 10^{-48}$ | 291.3            | 1.79          |
| Tin . . . . .         | 7.239  | $1.175 \times 10^{-21}$ | 299.8            | 1.84          |
| Copper . . . . .      | 3.902  | $1.439 \times 10^{-13}$ | 333.0            | 2.05          |
| Stainless steel . . . | 13.292 | $1.205 \times 10^{-38}$ | 423.7            | 2.61          |
| Cold-rolled steel . . | 6.639  | $2.793 \times 10^{-21}$ | 440.6            | 2.71          |
| At 10.3 $\mu$ F:      |        |                         |                  |               |
| Cadmium . . . . .     | 9.917  | $1.334 \times 10^{-19}$ | 39.9             | 1.00          |
| Aluminum . . . . .    | 30.484 | $1.028 \times 10^{-52}$ | 40.5             | 1.01          |
| Brass . . . . .       | 23.101 | $2.811 \times 10^{-42}$ | 46.6             | 1.17          |
| Copper . . . . .      | 24.744 | $5.902 \times 10^{-44}$ | 47.0             | 1.18          |
| Lead . . . . .        | 5.153  | $1.371 \times 10^{-12}$ | 52.5             | 1.32          |
| Tin . . . . .         | 9.265  | $4.406 \times 10^{-20}$ | 58.3             | 1.46          |
| Cold-rolled steel . . | 5.221  | $9.750 \times 10^{-14}$ | 82.7             | 2.07          |
| Stainless steel . . . | 12.352 | $5.521 \times 10^{-28}$ | 92.0             | 2.31          |
| At 107 $\mu$ F:       |        |                         |                  |               |
| Aluminum . . . . .    | 31.532 | $9.441 \times 10^{-43}$ | 17.3             | .83           |
| Copper . . . . .      | 48.744 | $5.957 \times 10^{-68}$ | 20.8             | 1.00          |
| Cadmium . . . . .     | 14.296 | $1.393 \times 10^{-22}$ | 20.8             | 1.00          |
| Brass . . . . .       | 28.858 | $3.443 \times 10^{-43}$ | 21.0             | 1.01          |
| Tin . . . . .         | 15.563 | $1.892 \times 10^{-24}$ | 21.5             | 1.03          |
| Lead . . . . .        | 23.051 | $1.578 \times 10^{-34}$ | 21.7             | 1.03          |
| Cold-rolled steel . . | 14.209 | $3.963 \times 10^{-24}$ | 27.3             | 1.31          |
| Stainless steel . . . | 24.384 | $4.634 \times 10^{-39}$ | 28.1             | 1.35          |
| At 1,310 $\mu$ F:     |        |                         |                  |               |
| Aluminum . . . . .    | 11.997 | $2.582 \times 10^{-15}$ | 9.2              | .70           |
| Cadmium . . . . .     | 60.003 | $6.516 \times 10^{-71}$ | 13.2             | 1.00          |
| Tin . . . . .         | 58.290 | $5.483 \times 10^{-70}$ | 13.7             | 1.05          |
| Copper . . . . .      | 23.110 | $4.093 \times 10^{-30}$ | 13.9             | 1.05          |
| Lead . . . . .        | 53.322 | $1.514 \times 10^{-66}$ | 15.1             | 1.14          |
| Brass . . . . .       | 44.320 | $2.218 \times 10^{-56}$ | 15.4             | 1.17          |
| Stainless steel . . . | 17.721 | $3.990 \times 10^{-25}$ | 16.1             | 1.22          |
| Cold-rolled steel . . | 27.649 | $5.675 \times 10^{-38}$ | 17.3             | 1.31          |

In breakflash testing, as the electrodes separate, an arc forms at the contact point. If this arc has sufficient energy, then an ignition will occur. In the case where inductance is low, i.e.,  $\leq 100$  mH, formation of the arc is almost always caused by vaporization of the contact point. This metallic vapor serves to conduct current as long as the circuit voltage can maintain it. Eventually, the arc gap becomes so great that the spark is quenched and current ceases to flow. At higher inductances, i.e., above 100 mH, formation of the arc may also be caused by vaporization of the contact material (5, p. 83).

Because the disk contact material vaporizes, it may be hypothesized that the boiling point of the material may influence how easily an arc is maintained in some circuits (5, pp. 86-89). For resistor and inductor circuits, a crude relationship exists between ignition current and boiling point for the elemental disk materials. This relationship is presented graphically in figures 20 and 21. These graphs have the form

$$IC = 10^{C(BP) + D}, \quad (6)$$

where IC = ignition current, mA,

and BP = boiling point, °C.

The values for C and D for each of the particular circuits are given in table 12. From this, a rough estimate of the ignition current is possible if the boiling point is known. No such relationship was found to exist for capacitor circuits.

Table 12.—Values of C and D for ignition current versus boiling point equation

|               | C                     | D    |             | C                     | D    |
|---------------|-----------------------|------|-------------|-----------------------|------|
| 30 V dc . . . | $2.84 \times 10^{-4}$ | 2.71 | 10 mH . . . | $1.45 \times 10^{-4}$ | 2.39 |
| 40 V dc . . . | $3.14 \times 10^{-4}$ | 2.41 | 100 mH . .  | $9.31 \times 10^{-5}$ | 2.00 |
| 50 V dc . . . | $3.29 \times 10^{-4}$ | 2.24 | 600 mH . .  | $2.18 \times 10^{-4}$ | 1.51 |
| 1 mH . . .    | $1.27 \times 10^{-4}$ | 2.75 |             |                       |      |

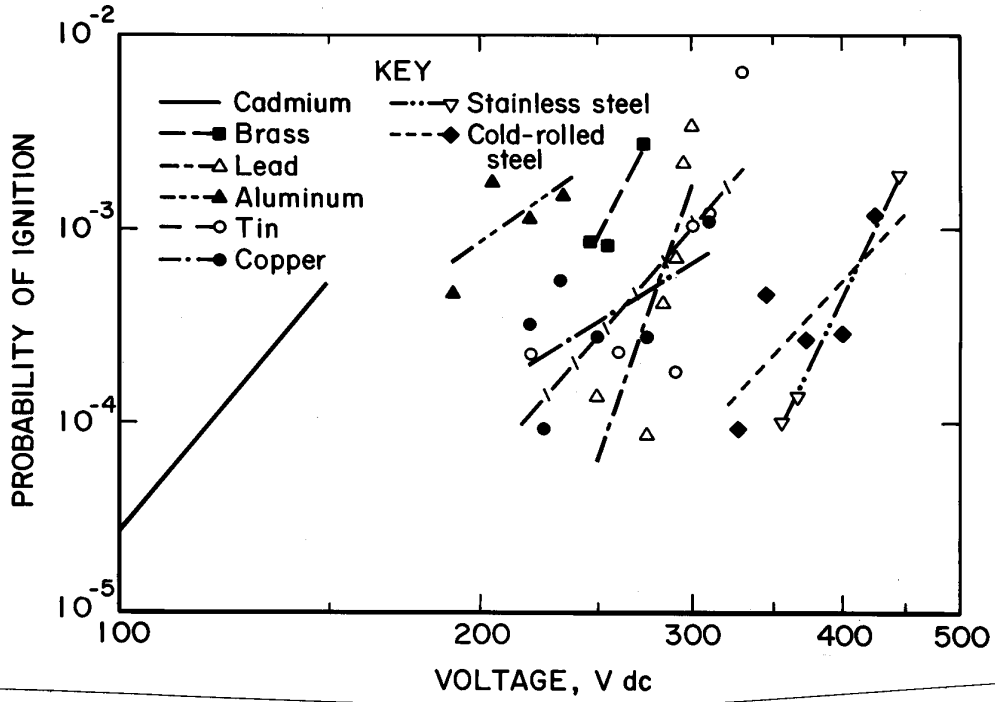

Figure 16.—Probability of ignition versus voltage results for 1.2-μF capacitor circuit.

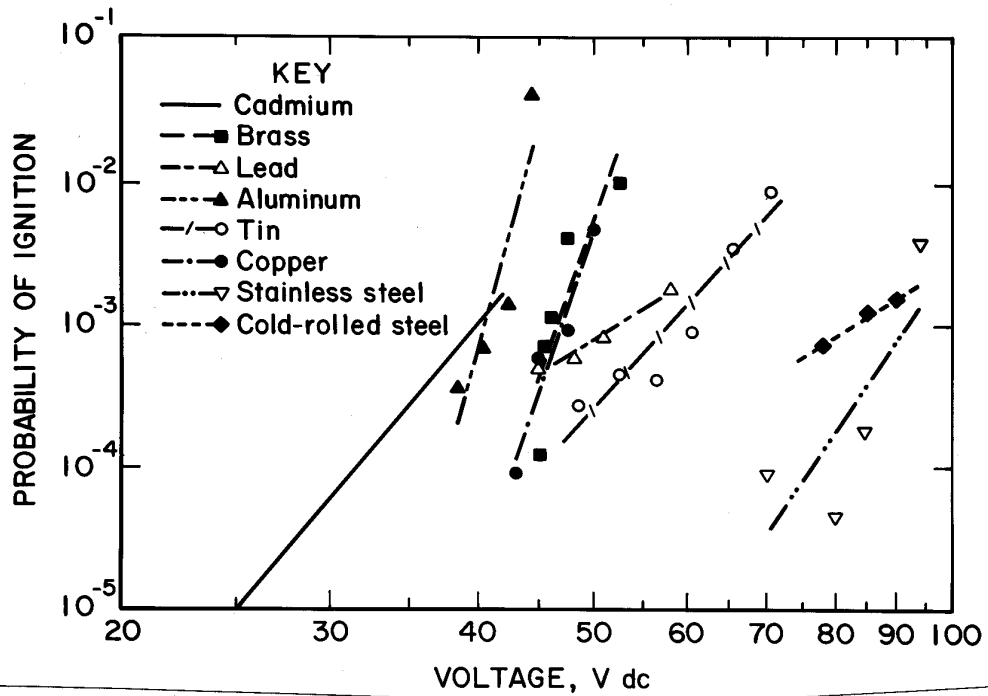

Figure 17.—Probability of ignition versus voltage results for 10.3-μF capacitor circuit.

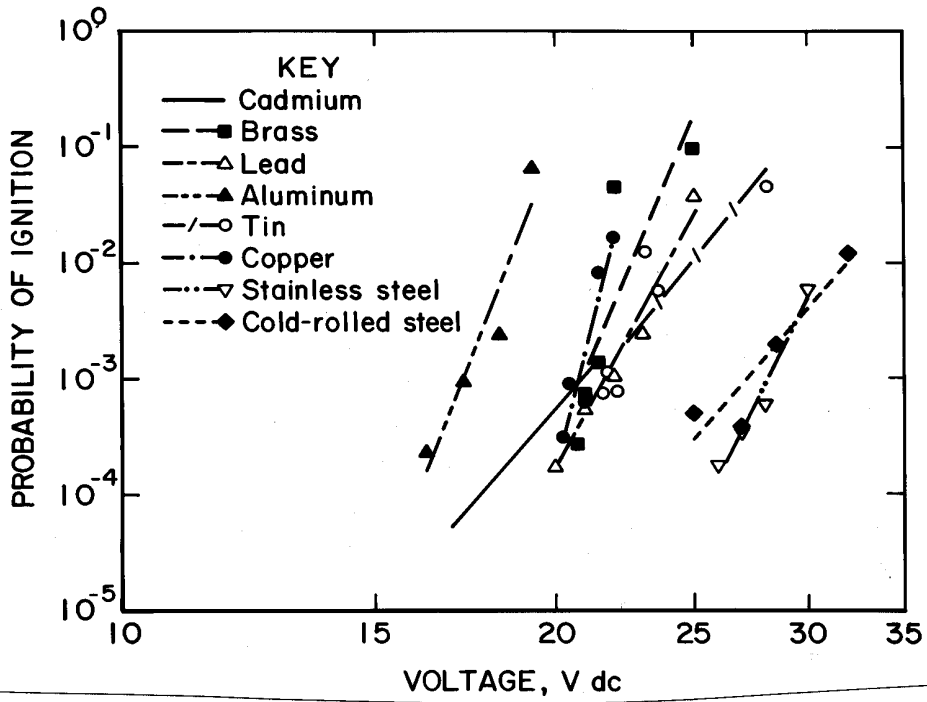

Figure 18.—Probability of ignition versus voltage results for 107- $\mu$ F capacitor circuit.

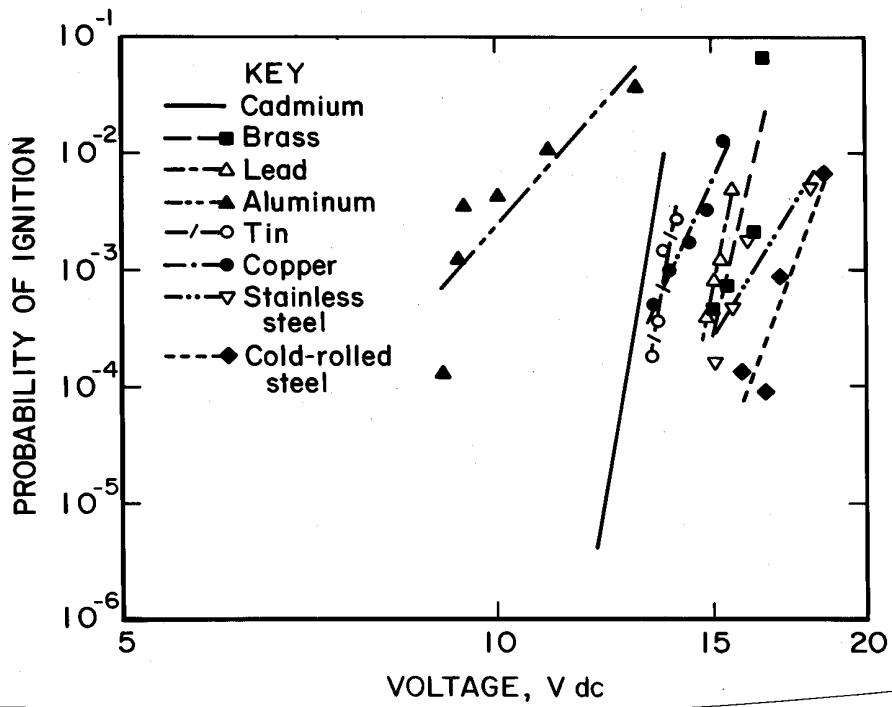

Figure 19.—Probability of Ignition versus voltage results for 1,310- $\mu$ F capacitor circuit.

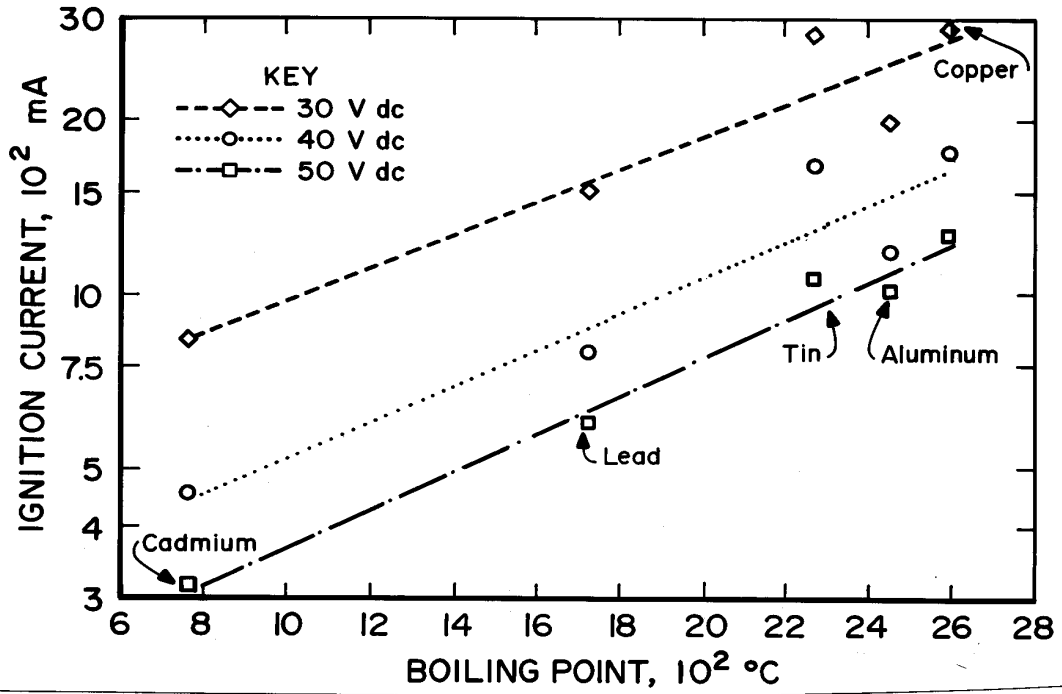

Figure 20.—Elemental disk material boiling point versus resistor circuit ignition current.

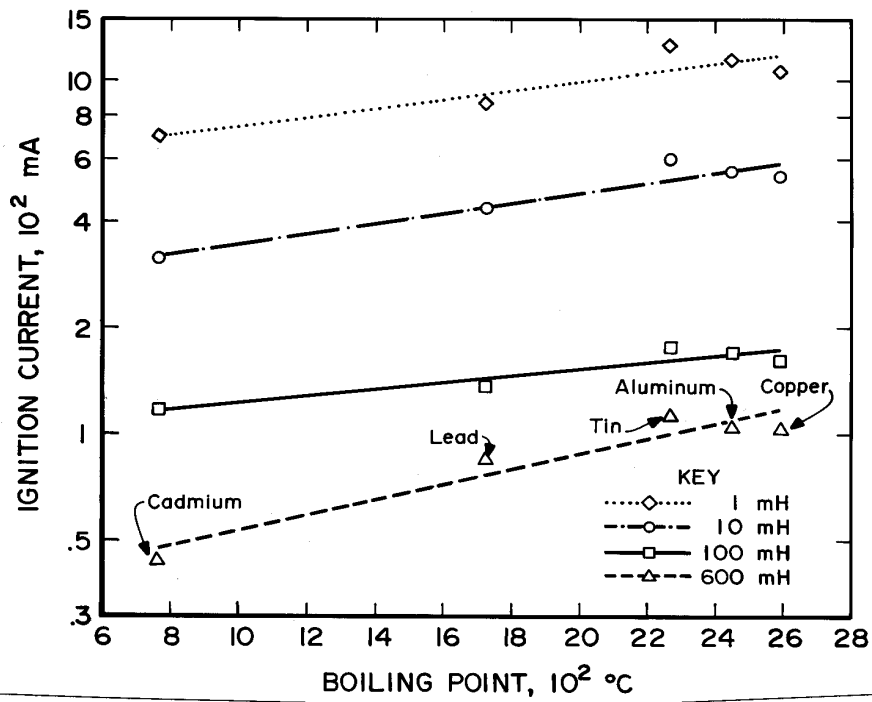

Figure 21.—Elemental disk material boiling point versus inductor circuit ignition current.

## CONCLUSIONS

This project was designed to generate ignition currents (voltages) producing a probability of ignition of  $10^{-3} \pm 5 \times 10^{-4}$ . The margin of safety attained when using materials other than cadmium is dependent upon disk electrode material in resistor or inductor circuits. Capacitor circuit results show a smaller margin of safety; it appears that other materials, aluminum in particular, require ignition

voltages comparable with those of cadmium. At several capacitances, aluminum exhibited lower ignition voltages than cadmium. Further research is needed to determine the cause of the wide range safety factors among the circuit types. Based on these results, the approval tests used by MSHA should not be modified to account for the safety factor provided by the material involved.

## REFERENCES

1. U.S. Code of Federal Regulations. Title 30—Mineral Resources; Chapter 1—Mine Safety and Health Administration, Department of Labor; Subchapter D—Electrical Equipment, Lamps, Methane Detectors; Tests for Permissibility; Fees; Part 18—Electric Motor-Driven Mine Equipment and Accessories. July 1, 1984, pp. 111-113.
2. American National Standards Institute. Standard ANSI/UL 913. Intrinsically Safe Apparatus for Use in Class I, II, III, Division 1. Hazardous (Classified) Locations. Underwriters Laboratories, Northbrook, IL, 4th ed., July 29, 1988, 41 pp.
3. Cawley, J. C. Probability of Resistive Spark Ignition Caused by Very Low Currents. BuMines RI 9114, 1987, 11 pp.
4. \_\_\_\_\_. Probability of Spark Ignition in Intrinsically Safe Circuits. BuMines RI 9183, 1988, 15 pp.
5. Magison, E. Electrical Instruments in Hazardous Locations. Instrum. Soc. Am., Research Triangle Park, NC, 3d ed., 1978, pp. 83, 86-89.