



ORAU TEAM Dose Reconstruction Project for NIOSH

Oak Ridge Associated Universities | Dade Moeller | MJV Technical Services

Page 1 of 127

DOE Review Release 04/21/2010

Document Title: Nevada Test Site – Occupational External Dose		Document Number: ORAUT-TKBS-0008-6 Revision: 02 Effective Date: 04/15/2010 Type of Document: TBD Supersedes: Revision 01 PC-1
Subject Expert(s): Richard V. Griffith Site Expert(s): N/A		
Approval: <u>Signature on File</u> Eugene M. Rollins, Document Owner	Approval Date: <u>04/13/2010</u>	
Concurrence: <u>Signature on File</u> John M. Byrne, Objective 1 Manager	Concurrence Date: <u>04/12/2010</u>	
Concurrence: <u>Keith A. McCartney Signature on File for</u> Edward F. Maher, Objective 3 Manager	Concurrence Date: <u>04/13/2010</u>	
Concurrence: <u>Signature on File</u> Kate Kimpan, Project Director	Concurrence Date: <u>04/12/2010</u>	
Approval: <u>Signature on File</u> James W. Neton, Associate Director for Science	Approval Date: <u>04/15/2010</u>	

New
 Total Rewrite
 Revision
 Page Change

FOR DOCUMENTS MARKED AS A TOTAL REWRITE, REVISION, OR PAGE CHANGE, REPLACE THE PRIOR REVISION AND DISCARD / DESTROY ALL COPIES OF THE PRIOR REVISION.

PUBLICATION RECORD

EFFECTIVE DATE	REVISION NUMBER	DESCRIPTION
09/21/2004	00	<p>Information contained in Revision 00 is applicable only to employment periods after 1962 (post-atmospheric testing phase) and to workers <u>not</u> identified as involved with drillback activities prior to 1965. In addition, Revision 00 is not applicable to dose reconstruction for (1) workers involved with weapons testing at locations other than the NTS (South Pacific, Alaska, etc.); (2) workers affected by any of the following 10 underground tests that resulted in unexpected release of radioactive material:</p> <ol style="list-style-type: none"> 1. BLANCA (October 30, 1958) 2. DES MOINES (June 13, 1962) 3. BANE BERRY (December 18, 1970) 4. CAMPHOR (June 29, 1971) 5. DIAGONAL LINE (November 24, 1971) 6. RIOLA (September 25, 1980) 7. AGRINI (March 31, 1984) 8. MIDAS MYTH (February 15, 1984) 9. MISTY RAIN (April 6, 1985) 10. MIGHTY OAK (April 10, 1986) <p>It is also assumed that, because they were such a rarity, it would be likely that if a claimant was involved in one of these events, he [or his survivor] would mention it in his CATI. All of these conditions are likely verifiable by careful examination of the DOL, DOE (incident reports and dosimetry records), and OCAS documents. Incorporates internal and NIOSH comments. Initiated by Eugene M. Rollins.</p>
07/21/2006	00 PC-1	<p>Approved page change revision incorporates definitions and directions for dose reconstruction for non-presumptive cancers that are excluded from the 1951 through 1962 Special Exposure Cohort. Text was added or modified on pages 8-9 in Section 6.1. Incorporates NIOSH formal review comments. No sections were deleted. This revision results in no change to the assigned dose and no PER is required. Training required: As determined by the Task Manager. Initiated by Eugene M. Rollins. Approval:</p> <p><u>Signature on File</u> 07/12/2006 Eugene M. Rollins, TBD Team Leader</p> <p><u>Signature on File</u> 07/12/2006 John M. Byrne, Task 3 Manager</p> <p><u>Signature on File</u> 07/14/2006 Edward F. Maher, Task 5 Manager</p> <p><u>Signature on File</u> 07/20/2006 Kate Kimpan, Project Director</p> <p><u>Signature on File</u> 07/21/2006 James W. Neton, Associate Director for Science</p>

EFFECTIVE DATE	REVISION NUMBER	DESCRIPTION
01/11/2007	00 PC-2	<p>Approved page change revision incorporates coworker data for completion of external dose prior to universal badging in April 1957. Text was added or modified on pages 40-42 in Sections 6.3.4.1. Added DeMarre reference on page 50. Deleted the term, claimant favorable, from the Glossary on page 54. As a result of changes, corrected table references on page 46 and 48. No further changes occurred as a result of internal formal review. Incorporates NIOSH formal review comments. No sections were deleted. This revision results in an increase in assigned dose and a PER is required. Training required: As determine by the Task Manager. Initiated by Eugene M. Rollins. Approval:</p> <p><u>Signature on File</u> 12/15/2006 Eugene M. Rollins, TBD Team Leader</p> <p><u>Signature on File</u> 12/12/2006 John M. Byrne, Task 3 Manager</p> <p><u>Signature on File</u> 12/12/2006 Edward F. Maher, Task 5 Manager</p> <p><u>Signature on File</u> 01/11/2007 Kate Kimpan, Project Director</p> <p><u>Brant A. Ulsh Signature on File for</u> 01/11/2007 James W. Neton, Associate Director for Science</p>
07/30/2007	01	<p>Approved Revision 01 initiated to add Section 6.4 Dose Reconstruction Recommendations, Section 6.5 Claim Analysis Methods. Added Attachments A through D. Constitutes a total rewrite of the document. Incorporates formal internal and NIOSH review comments. Adds Attributions and Annotations section. Training required: As determine by the Task Manager. Initiated by Eugene M. Rollins.</p>
05/28/2008	01 PC-1	<p>Approved page change revision to incorporate expanded co-worker data on pages 45 - 47, 49, and 50 in Section 6.4. Text was added to Section 6.5.1 (page 57) and Section 6.5.2 (page 58) to address hot particle issues and the use of the document Hazards to Personnel Re-entering the Nevada Test Site Following Nuclear Reactor Tests. Changes to attributions and annotations numbering were made on pages 59-61, 67, 68, 92, and 95. No sections were deleted. Made additional changes to correct the wording in Section 6.5.1 on page 57 to be consistent with the information in Section 6.3.5.1 on page 36 regarding the lead covering on the dosimetry and identification of the 25% as a dose correction factor between the years 1960 and 1965. Corrected the dates in Section 6.3.5.1 on page 36 to be consistent with the dates in Table 6-1. Added information for Operations BREN and HENRE and the Super Kukla reactor. As a result of NIOSH formal reievw, the following pages were changed: 9, 12, 13, 17-19, 21, 24 - 34, 36, 37, 39 - 42, 44 - 47, 49 - 66, 68, 71 - 78, 93 - 95, 101, 102, 104, 105, and 110. These changes occurred in the Acronyms and Abbreviations Section, Sections 6.1, 6.3, 6.4, 6.5, 6.6, Reference Section, Glossary Section and Attachment A. Training required: As</p>

EFFECTIVE DATE	REVISION NUMBER	DESCRIPTION
		<p>determined by the Task Manager. Initiated by Eugene M. Rollins. Approval:</p> <p><u>Signature on File</u> <u>04/23/2008</u> Eugene M. Rollins, Document Owner</p> <p><u>Signature on File</u> <u>05/14/2008</u> John M. Byrne, Task 3 Manager</p> <p><u>Signature on File</u> <u>04/22/2008</u> Edward F. Maher, Task 5 Manager</p> <p><u>Signature on File</u> <u>05/14/2008</u> Kate Kimpan, Project Director</p> <p><u>Brant A. Ulsh Signature on File for</u> <u>05/28/2008</u> James W. Neton, Associate Director for Science</p>
04/15/2010	02	<p>Revision initiated to incorporate definitions and directions for dose reconstruction for nonpresumptive cancers that are excluded from the 1963 through 1992 Special Exposure Cohort. Changes were made to Sections 6.3.5.1 and 6.5.1 to clarify the application of a 25% dosimeter correction factor for all energy ranges prior to 1966 to account for lead shielding in some dosimeters. Table 6-1, footnote d was revised to reflect this change. Added Section 6.1.2. Incorporates formal internal and NIOSH review comments. Training required: As determined by the Task Manager. Initiated by Eugene M. Rollins.</p>

TABLE OF CONTENTS

<u>SECTION</u>	<u>TITLE</u>	<u>PAGE</u>
	Acronyms and Abbreviations	10
6.1	Introduction	13
6.1.1	Purpose	14
6.1.2	Special Exposure Cohort Petition Information for the Nevada Test Site	14
6.1.3	Scope.....	15
6.2	Dosimetric Basis of Comparison	15
6.2.1	Photon Measurement Quantities	16
6.2.2	Beta Measurement Quantities	17
6.2.3	Neutron Measurement Quantities.....	17
6.3	Dose Reconstruction Parameters.....	17
6.3.1	Administrative Practices	22
6.3.1.1	Exposure Limits	23
6.3.1.2	Dosimeter Exchange	24
6.3.1.3	Dosimetry Codes for External Monitoring	24
6.3.1.4	Duplicate Dosimetry Records	25
6.3.1.5	Special Issues	27
6.3.1.5.1	External Exposure to "Hot Particles"	27
6.3.1.5.2	Intentional Nonuse of Dosimeters	28
6.3.2	Individual Monitoring Methods.....	28
6.3.2.1	Beta/Gamma Dosimeters	28
6.3.2.1.1	Beta Dosimetry with Film Badges	31
6.3.2.2	Neutron Dosimeters	32
6.3.2.2.1	Film Dosimeters.....	32
6.3.2.2.2	Thermoluminescent Albedo Dosimeters.....	33
6.3.2.2.3	Track Etch Detectors	33
6.3.2.2.4	Panasonic 809.....	33
6.3.2.3	Extremity Monitoring	33
6.3.3	Calibration	34
6.3.3.1	Photons.....	34
6.3.3.2	Neutrons	35
6.3.4	Limit of Detection	35
6.3.4.1	Gamma Dosimeters	35
6.3.4.1.1	Film.....	35
6.3.4.1.2	TLD.....	36
6.3.4.2	Neutron Dosimeters	37
6.3.4.2.1	NTA Film.....	37
6.3.4.2.2	TLD Albedo.....	37
6.3.4.2.3	Track Etch Detectors	38
6.3.5	Workplace Radiation Fields.....	38
6.3.5.1	Photon Fields	38
6.3.5.1.1	Nuclear and Ramjet Engine Tests and Other Reactor Tests	39
6.3.5.1.2	Noble Gas Exposure.....	40
6.3.5.2	Beta Particle Fields	41
6.3.5.3	Neutron Fields.....	41
6.3.5.3.1	Weapons-Related Neutron Fields	42
6.3.5.3.2	Isotopic Neutron Sources.....	43

6.3.5.3.3	Reactor Operations.....	43
6.3.5.3.4	Dosimetric Characteristics of Neutron Fields	43
6.4	Dose Reconstruction Recommendations	45
6.4.1	Photon Radiation	45
6.4.1.1	Unmonitored External Radiation Photon Dose	45
6.4.1.2	Adjustments to Recorded External Photon Radiation Dose.....	45
6.4.1.3	Missed Recorded External Radiation Dose	46
6.4.1.4	IREP Input Photon Radiation Energy Fractions.....	46
6.4.1.5	Determination of Radiation Quantities and Exposure Geometry.....	49
6.4.1.6	Correction Factors for External Environmental Dose	49
6.4.2	Beta Radiation	50
6.4.2.1	Evaluation of Beta Exposure Geometries.....	50
6.4.2.2	Beta-Photon Ratios for Surface Contamination	51
6.4.2.3	Beta-Photon Ratios for Immersion in a Contaminated Cloud.....	51
6.4.2.4	Beta-Photon Ratios for Other NTS Operational Areas.....	52
6.4.2.5	Estimation of Beta-Photon Exposure.....	52
6.4.2.6	Skin Contamination	53
6.4.3	Neutron Radiation	53
6.4.3.1	Energy Dependence of Dosimetric Quantities	53
6.4.3.2	Neutron-to-Photon Dose Ratios	55
6.4.3.3	Special Considerations	56
6.5	Claim Analysis Methods	56
6.5.1	Photon Dose	56
6.5.2	Beta Dose	58
6.5.3	Neutron Dose.....	60
6.6	Attributions and Annotations	62
	References	69
	Glossary	81
	ATTACHMENT A, DOSIMETRY TECHNOLOGY	88
A.1	Beta/Gamma Dosimetry	88
A.1.1	Photographic Film Dosimeters.....	88
A.1.2	Thermoluminescent Dosimeters	91
A.1.2.1	NRDS Thermoluminescent Dosimeters.....	91
A.1.2.2	REEC _o Thermoluminescent Dosimeters	92
A.1.2.3	Energy Response.....	93
A.1.2.4	Dose Measurement.....	95
A.1.2.5	Calibration.....	95
A.2	Neutron Dosimetry	96
A.2.1	NTA Film	96
A.2.2	TLD Albedo Detectors	98
A.2.3	Track Etch Detectors	98
A.2.3.1	Dose Algorithms.....	100
A.3	Quality Assurance.....	101

A.4	Beta Particle Field Characteristics.....	102
A.5	Neutron Field Characteristics	104
ATTACHMENT B, ENERGY GROUP ALLOCATION OF PHOTON EXPOSURE AND PERSONAL DOSE EQUIVALENT BY NTS WORK AREA AND OPERATION.....		108
B.1	Introduction	108
B.2	Work Area and Operation-Dependent Energy Group Photon Fractions.....	108
ATTACHMENT C, BETA-PHOTON RATIO ESTIMATES FOR NTS WORK AREAS AND OPERATIONS.....		110
C.1	Introduction	110
C.2	Beta-Photon Ratios from Standing on a Contaminated Surface Following Nuclear Test or Reactor Operation	111
C.3	Beta-Photon Ratios from Immersion in a Contaminated Cloud Following Nuclear Test or Reactor Operation.....	113
C.4	Beta-Photon Ratios for Other Geometries.....	115
C.4.1	Photon Dose Constants	115
C.4.2	Beta Dose Rates.....	119
C.5	Summary of Beta-Photon Ratios.....	121
ATTACHMENT D, NEUTRON DOSES FROM ATMOSPHERIC NUCLEAR TESTS		123
D.1	Introduction	123
D.2	Neutron Dose as a Function of Distance	123

LIST OF TABLES

<u>TABLE</u>	<u>TITLE</u>	<u>PAGE</u>
6-1	NTS external dosimetry—1951 to present	19
6-2	NTS film badge issue locations	23
6-3	Type of dose codes for external dosimetry	25
6-4	Film damage and irregularity codes	25
6-5	Characteristics of ISO reference radiation radionuclide sources used for neutron dosimeter calibration	35
6-6	Background dose equivalent rates	36
6-7	NTS Panasonic UD-802 detection limits for DOELAP categories	37
6-8	Primary iodines and fission product noble gases with half-lives greater than 1 hr.....	40
6-9	Areas and operations where neutron exposure was possible	42
6-10	RBE, quality factors, or weighting factors for neutrons	44
6-11	NTS calculated dose to apply as co-worker dose	46
6-12	NTS associated measured doses.....	47
6-13	NTS work area and operation-dependent photon fractions.....	49
6-14	Beta-photon ratios for exposure from surface contamination.....	51
6-15	Beta-photon ratios for exposure from immersion in an infinite cloud of mixed fission and activation products	52
6-16	Fraction of $H_p(10,0^\circ)$ by energy band for selected spectra	54
6-17	Neutron field characteristics associated with NTS operational areas.....	54
6-18	Neutron-to-photon dose ratios for isotopic sources	55
6-19	Summary of beta dose assignment	59
A-1	Panasonic UD-802 dosimeter configuration	93
A-2	Photon exposure to dose correction factors for NIST reference radiations	95
A-3	Bias values and uncertainties for NTS DOELAP accreditation categories	102
A-4	Fraction of $H_p(10,0)$ for neutrons with energies less than E_n	107
B-1	Work area and operation-dependent photon fractions.....	109
C-1	Calculated beta-photon ratios for mixed fission and activation products from Sedan and tests from Operations Ranger, Buster-Jangle, Tumbler- Snapper, and Upshot-Knothole—contaminated surfaces	114
C-2	Calculated beta-photon ratios for mixed fission and activation products from Operations Ranger, Buster-Jangle, Tumbler-Snapper, and Upshot- Knothole tests—immersion in a contaminated semi-infinite cloud	116
C-3	Photon dose constants, beta dose rates, and beta-photon ratios for NTS radionuclides.....	117
C-4	Geometry-dependent beta-photon ratios for NTS radionuclides	121

LIST OF FIGURES

<u>FIGURE</u>	<u>TITLE</u>	<u>PAGE</u>
6-1	Security badge for NRDS TLD	29
6-2	REECo badge holder	30
6-3	REECo security badge holder with Panasonic UD-802 dosimeter.....	30
6-4	X-ray energy dependence of PICs	31
6-5	Panasonic UD-807 extremity dosimeter	34
6-6	Ratio of fluence to dose conversion coefficients for personal dose equivalent $H_p(10, 0^\circ)$ to conversion coefficients for dose equivalent H	44
A-1	Typical photon energy response curves for $\text{Li}_2\text{B}_4\text{O}_7$ and CaSO_4 TLD elements	94
A-2	Panasonic UD-802 energy responses	94
A-3	NTA film neutron energy response.....	97
A-4	Neutron energy response of NTS albedo dosimeters	98
A-5	Neutron energy response of NTS TED.....	99
A-6	Electrochemically etched CR-39 dose response	100
A-7	Lethargy neutron spectra for ^{252}Cf calibration source with and without room scatter	105
A-8	Lethargy neutron spectra for ^{252}Cf with various thickness moderators.....	105
A-9	Lethargy neutron spectra for an $^{241}\text{AmBe}$ calibration source with and without room scatter.....	106
A-10	Fraction of $H_p(10,0)$ due to neutrons with energies less than E_n	106
C-1	Beta-to-gamma dose ratios for contaminated surfaces used at Pacific tests	112
C-2	Calculated beta-photon ratios for skin for 11 atmospheric tests from Operation Upshot-Knothole.....	113
C-3	Calculated beta-photon ratios for skin for nuclear rockets and ramjet test effluents	113
C-4	Calculated beta-photon ratios for immersion in a contaminated semi-infinite cloud—maximum of values from 11 atmospheric test radionuclide inventories	117
D-1	Neutron spectra for (a) fission weapon and (b) thermonuclear weapon per kiloton total energy yield.....	124
D-2	Initial neutron dose per kT as a function of slant range from (a) fission and (b) thermonuclear air bursts, based on 0.9 normal sea-level air density	124
D-3	Comparison of the initial neutron dose per kiloton as a function of slant range from fission and thermonuclear air bursts.....	125
D-4	Neutron dose equivalent as a function of slant range for atmospheric detonations with a range of weapon yields.....	125
D-5	1-mrem neutron isodose curves for continental detonations.....	127

ACRONYMS AND ABBREVIATIONS

AEC	U.S. Atomic Energy Commission
ALARA	as low as reasonably achievable
BREN	Bare Reactor Experiment Nevada
C	coulomb
cm	centimeter
CR-39	Columbia Resin-39
d	day
DOD	U.S. Department of Defense
DOE	U.S. Department of Energy
DOELAP	DOE Laboratory Accreditation Program
DOL	U.S. Department of Labor
ECF	element correction factor
EEOICPA	Energy Employees Occupational Illness Compensation Program Act
EG&G	Edgerton, Germeshausen and Grier
eV	electron volt
GSD	geometric standard deviation
H&N	Holmes & Narver
HENRE	High Energy Neutron Reactions Experiment
$H_p(d)$	personal dose equivalent (d = depth in millimeters)
HPRR	Health Physics Research Reactor
hr	hour
HRA	High Radiation Area
Hz	hertz
IARC	International Agency for Research on Cancer
ICRP	International Commission for Radiological Protection
ICRU	International Commission on Radiological Units and Measurements
IDO	Idaho Operations Office
in.	inch
ISO	International Organization for Standardization
IREP	Interactive RadioEpidemiological Program
keV	kilovolt-electron
kg	kilogram
km	kilometer
kT	kiloton
kV	kilovolt
LANL	Los Alamos National Laboratory
LASL	Los Alamos Scientific Laboratory
LLD	lower limit of detection
LLNL	Lawrence Livermore National Laboratory
LRL	Lawrence Radiation Laboratory

m	meter
MBq	megabecquerel
MDL	minimum detection level
MeV	megavolt-electron
mg	milligram
mGy	milligray
mi	mile
min	minute
mm	millimeter
MMD	maximum missed dose
mR	milliroentgen
mrem	millirem
mSv	millisievert
MT	megaton
NBS	National Bureau of Standards
NCRP	National Council on Radiation Protection and Measurements
NIOSH	National Institute for Occupational Safety and Health
NIST	National Institute of Standards and Technology
nm	nanometer
NPG	Nevada Proving Ground
NRDS	Nuclear Rocket Development Station
NTA	Neutron Track Emulsion, type A
NTS	Nevada Test Site
OW	open window
Pan Am	Pan American Airways
PIC	pocket ionization chamber
POC	probability of causation
QA	quality assurance
QC	quality control
R	roentgen
RADEX	controlled radiation exclusion (area)
RBE	relative biological effectiveness
RCF	run calibration factor
REECo	Reynolds Electrical and Engineering Company
RSN	Raytheon Services Nevada
SEC	Special Exposure Cohort
SNL	Sandia National Laboratories
Sv	sievert
TBD	technical basis document
TED	track etch detector
TLD	thermoluminescent dosimeter
TRU	transuranic
TTR	Tonopah Test Range
U.S.C.	United States Code

wk	week
yd	yard
YMP	Yucca Mountain Project
yr	year
Z	atomic number
µm	micrometer
°C	degree Celsius
°F	degree Fahrenheit
§	Section

6.1 INTRODUCTION

Technical basis documents and site profile documents are not official determinations made by the National Institute for Occupational Safety and Health (NIOSH) but are rather general working documents that provide historic background information and guidance to assist in the preparation of dose reconstructions at particular sites or categories of sites. They will be revised in the event additional relevant information is obtained about the affected site(s). These documents may be used to assist NIOSH staff in the completion of the individual work required for each dose reconstruction.

In this document the word “facility” is used as a general term for an area, building, or group of buildings that served a specific purpose at a site. It does not necessarily connote an “atomic weapons employer facility” or a “Department of Energy [DOE] facility” as defined in the Energy Employees Occupational Illness Compensation Program Act [EEOICPA; 42 U.S.C. § 7384l(5) and (12)]. EEOICPA defines a DOE facility as “any building, structure, or premise, including the grounds upon which such building, structure, or premise is located ... in which operations are, or have been, conducted by, or on behalf of, the Department of Energy (except for buildings, structures, premises, grounds, or operations ... pertaining to the Naval Nuclear Propulsion Program)” [42 U.S.C. § 7384l(12)]. Accordingly, except for the exclusion for the Naval Nuclear Propulsion Program noted above, any facility that performs or performed DOE operations of any nature whatsoever is a DOE facility encompassed by EEOICPA.

For employees of DOE or its contractors with cancer, the DOE facility definition only determines eligibility for a dose reconstruction, which is a prerequisite to a compensation decision (except for members of the Special Exposure Cohort). The compensation decision for cancer claimants is based on a section of the statute entitled “Exposure in the Performance of Duty.” That provision [42 U.S.C. § 7384n(b)] says that an individual with cancer “shall be determined to have sustained that cancer in the performance of duty for purposes of the compensation program if, and only if, the cancer ... was at least as likely as not related to employment at the facility [where the employee worked], as determined in accordance with the POC [probability of causation¹] guidelines established under subsection (c) ...” [42 U.S.C. § 7384n(b)]. Neither the statute nor the probability of causation guidelines (nor the dose reconstruction regulation, 42 C.F.R. Pt. 82) define “performance of duty” for DOE employees with a covered cancer or restrict the “duty” to nuclear weapons work (NIOSH 2007a).

The statute also includes a definition of a DOE facility that excludes “buildings, structures, premises, grounds, or operations covered by Executive Order No. 12344, dated February 1, 1982 (42 U.S.C. 7158 note), pertaining to the Naval Nuclear Propulsion Program” [42 U.S.C. § 7384l(12)]. While this definition excludes Naval Nuclear Propulsion Facilities from being covered under the Act, the section of EEOICPA that deals with the compensation decision for covered employees with cancer [i.e., 42 U.S.C. § 7384n(b), entitled “Exposure in the Performance of Duty”] does not contain such an exclusion. Therefore, the statute requires NIOSH to include all occupationally-derived radiation exposures at covered facilities in its dose reconstructions for employees at DOE facilities, including radiation exposures related to the Naval Nuclear Propulsion Program. As a result, all internal and external occupational radiation exposures are considered valid for inclusion in a dose reconstruction. No efforts are made to determine the eligibility of any fraction of total measured exposure for inclusion in dose reconstruction. NIOSH, however, does not consider the following exposures to be occupationally derived (NIOSH 2007a):

- Background radiation, including radiation from naturally occurring radon present in conventional structures
- Radiation from X-rays received in the diagnosis of injuries or illnesses or for therapeutic reasons

¹ The U.S. Department of Labor (DOL) is ultimately responsible under the EEOICPA for determining the POC.

6.1.1 Purpose

The purpose of this document is to describe Nevada Test Site (NTS) external dosimetry systems and practices. This information will be used as needed to evaluate external occupational doses for EEOICPA claimants.

Attributions and annotations, indicated by bracketed callouts and used to identify the source, justification, or clarification of the associated information, are presented in Section 6.6.

6.1.2 Special Exposure Cohort Petition Information for the Nevada Test Site

The current status of Special Exposure Cohort (SEC) petitions for the NTS is:

Classes Added to the SEC

- Department of Energy (DOE) employees or DOE contractor or subcontractor employees who worked at the Nevada Test Site from January 27, 1951 through December 31, 1962 for a number of work days aggregating at least 250 work days, either solely under this employment or in combination with work days within the parameters (excluding aggregate work day requirements) established for other classes of employees included in the SEC, and who were monitored or should have been monitored (NIOSH 2006a).

Classes Recommended by NIOSH for Addition to the SEC

- All employees of the Department of Energy, its predecessor agencies, and its contractors and subcontractors who worked at the Nevada Test Site from January 1, 1963 through December 31, 1992 for a number of work days aggregating at least 250 work days, occurring either solely under this employment or in combination with work days within the parameters established for one or more other classes of employees included in the SEC (NIOSH 2010).

NIOSH has determined, and the Secretary of Health and Human Services has concurred, that in the absence of bioassay results for the worker, internal doses cannot be reconstructed between 1951 and 1962 inclusive for an Energy Employee. Based on the SEC petition evaluation, internal dose is not to be reconstructed for work before 1963 unless a worker has specific bioassay results that can be directly related to an event or incident. Any internal dosimetry results in the DOE files for NTS workers before 1963 should be assumed to be valid; therefore, these results can be used to evaluate internal dose.

NIOSH believes that there is insufficient information to support bounding internal dose (reconstructing internal dose with sufficient accuracy) adequately for the portion of the SEC 00084 (NIOSH 2010) NTS worker class who worked during the period of testing from 1963 through 1992. NIOSH also believes that the cessation of nuclear testing, coupled with the implementation of the 1993 NTS internal technical basis document that demonstrates NTS compliance with 10 CFR Part 835, supports NIOSH's ability to bound internal dose for the evaluated class starting in 1993. Based on this information, NIOSH has identified the need to modify its position originally stated in the SEC 00084 NTS Evaluation Report (NIOSH 2007b). NIOSH recommends including all employees of DOE, its predecessor agencies, and its contractors and subcontractors who worked at NTS from January 1, 1963, through December 31, 1992, for a number of workdays aggregating at least 250 workdays, occurring either solely under this employment or in combination with workdays within the parameters established for one or more other classes of employees in the SEC. Although NIOSH recommends adding this portion of the class to the SEC, it intends to use available internal and external data for the recommended period (that can be interpreted using its existing processes or procedures) for partial dose reconstructions.

Dose reconstruction guidance in this TBD for periods before January 1, 1993, is presented to provide a technical basis for partial dose reconstructions for nonpresumptive cancers not covered in the SEC class through December 31, 1992. Although NIOSH found that it is not possible to bound internal dose for the proposed class, it intends to use internal and external monitoring data that might become available for an individual claim (and that can be interpreted using its existing dose reconstruction processes or procedures). Therefore, dose reconstructions for individuals employed at NTS during the period from 1951 through December 31, 1992, but who do not qualify for inclusion in the SEC, can be performed using these data as appropriate.

6.1.3 Scope

NTS operations played an important role in the U.S. nuclear weapons program. During the period when the U.S. tested nuclear weapons, radiation exposure monitoring of Energy Employee civilian and U.S. military personnel associated with that testing was performed using portable radiation instrumentation and personnel film dosimeters (NRC 1989). Operations at NTS involved atmospheric and underground weapons tests, experimental reactor tests intended for aircraft and rocket propulsion, and low-level transuranic (TRU) waste disposal (REECo 1995a; Allen and Schoengold 1995). NTS workers received exposures from a range of fission and activation products from test programs conducted beginning in the early 1950s. Exposure venues of particular significance include sample and measurement device recovery to assess weapon yields, terrestrial and airborne fallout plume tracking, aircraft operations (when used) for weapon assembly deployment and surveillance, and post event decontamination processes [1].

Radiation monitoring and control programs instituted with the mission of NTS included personal dosimetry, area monitoring, source term characterization, and measurements of fallout (contamination) dispersion [1]. As NTS test programs progressed, efforts to measure exposures and limit dose improved (Allen and Schoengold 1995; DeMarre 2002). The atmospheric nuclear test series consisted of a number of operations between 1951 and 1958, and again from 1961 to 1963 (DOE 2000). Each operation consisted of a number of individual tests. Underground nuclear testing occurred at NTS as early as 1958 and continued to 1992 (DOE 2000).

This TBD contains supporting documentation to assist in the evaluation of occupational external doses from these processes using the methodology in the *External Dose Reconstruction Implementation Guidelines* (NIOSH 2006b). NIOSH considers the available data and methods for performing external dose reconstruction to be adequate for estimating with sufficient accuracy the external radiation doses at NTS from 1951 to the present.

6.2 DOSIMETRIC BASIS OF COMPARISON

Since the start of the Manhattan Engineer District program in the early 1940s, various dosimetric concepts and quantities have been used to measure and record occupational exposure from external radiation sources. The selection of the measurement quantities to be used for radiation protection was initially based on the radiation interaction properties of the primary radiations of interest – photons (X- and gamma rays), electrons (beta particles), and neutrons – and the measurement methods employed. Sections 6.2.1 to 6.2.3 discuss these quantities briefly.

The problem with the use of different quantities for different radiations is that it prevented *direct* comparison of measurements of the three primary radiation qualities. In the 1950s the industry recognized a need for a special quantity to facilitate comparison of measurements of the various radiation qualities. The concepts of *quality factor* and *dose equivalent* were formally introduced by the International Commission for Radiological Protection (ICRP) and the International Commission on Radiation Units and Measurements (ICRU) in 1962 (ICRU 1962). The *special* unit of *dose equivalent*

was the rem. As early as 1961, NTS radiation exposure criteria and guidance were given in rem (AEC 1961).

In 1985, the ICRU defined a new set of *operational quantities* defined as radiation quantities for operational radiation protection measurement purposes (ICRU 1993). These quantities have a common definition for the three primary radiation qualities, so they have the advantage that they provide a means of direct comparison of measurements for these radiations.

The *operational quantity* recommended for individual or personal monitoring is the personal dose equivalent $H_p(d)$, where d is the depth (in millimeters) and represents the point of reference for dose in tissue. For weakly penetrating radiation of significance to skin dose, d is 0.07 mm and the operational quantity is noted as $H_p(0.07)$. For strongly penetrating radiation of significance to whole-body dose, d is 10 mm and the operational quantity is noted as $H_p(10)$. Both $H_p(0.07)$ and $H_p(10)$ are recommended as the operational quantities to be recorded for radiological protection proposed by the ICRU (1993).

These personal dose equivalents, $H_p(0.07)$ and $H_p(10)$, have been used in the DOE Laboratory Accreditation Program (DOELAP) for accreditation of the Department's personnel dosimetry systems since the 1980s (DOE 1986a). The International Agency for Research on Cancer (IARC) Three Country Combined Study (Fix et al. 1997; Fix, Wilson, and Baumgartner 1997) and IARC Collaborative Study (Thierry-Chef et al. 2002) selected $H_p(10)$ as the quantity to assess error in recorded whole-body dose for workers in IARC nuclear worker epidemiologic studies.

6.2.1 Photon Measurement Quantities

From the beginning of operations at NTS, *exposure* was used as the basis of photon measurement. When in italics, the term *exposure* designates a radiation measurement quantity based on the electrical charges created in air due to interaction of photons. It is specific to *air* and *photon* measurement. The unit of *exposure* is coulomb per kilogram, and the special unit of *exposure* is the roentgen ($1 \text{ R} = 2.58 \times 10^{-4} \text{ C/kg}$). Although the term *exposure dose* was used in the mid-1950s, *exposure* is not dose because it is not a measure of energy deposition in mass of material. The ICRU recommended the use of *exposure* in 1962 (ICRU 1962). However, dose in soft tissue can be determined from *exposure* by the following relationship,

$$D = fX$$

where f is a constant that relates the *exposure* X in roentgen for a given photon energy to dose in soft tissue, and was typically taken to be 0.877 rad/R. Because 1 R is numerically slightly greater than 1 rad, it is favorable to claimants to assume a numerical equivalence of the two quantities. Therefore, if the energy and hence the constant f of the exposing photon radiation are unknown, it is appropriate to assume that 1 R equals 1 rad, which equals 10 mGy.

Instrument and dosimeter calibrations, dose measurements, and dose records were made in terms of exposure in units of milliroentgen. However, as noted above, from 1961 quarterly and annual limits were specified in millirem (AEC 1961), where the general term *dose* was used without specific reference to *dose equivalent*. As a result, individual monitoring results at NTS were recorded in millirem, although the measurements had been made in terms of *exposure*. However, for photons, the values of *exposure* and dose equivalent were considered to be essentially the same (Griffith 2004; Brady and Iverson 1968). In effect, a *de facto* conversion factor of 1 rem/R was used for dose recording purposes.

Until July 1970, individual monitoring at the Nuclear Rocket Development Station (NRDS) was provided by the Reynolds Electrical and Engineering Company (REECo) using the standard NTS film

dosimeter (Boone, Bennett, and Adams 1970). From July 1970 until NRDS operations ceased in January 1973, individual monitoring was conducted by Pan American World Airways (Pan Am) using thermoluminescent dosimeters (TLDs) (Boone, Bennett, and Adams, 1970). However, throughout NRDS operations, dosimeters were calibrated in terms of exposure and doses were recorded in millirem.

Beginning in 1987, NTS occupational exposures were recorded in terms of *personal dose equivalent*, $H_P(d)$. For exposures during the period from 1962 to 1986, dose reconstructors should use the recorded photon dose values in terms of *exposure*, together with the *Exposure to Organ Dose* coefficients in Appendix B of NIOSH (2006b) to determine organ dose. Since 1987, the recorded values are in terms of $H_P(10)$, and the Deep-Dose-Equivalent-to-Organ-Dose conversion factors (of NIOSH 2006b, Appendix B) should be used.

6.2.2 Beta Measurement Quantities

As was common practice, NTS beta particle measurements were made in terms of *absorbed dose*, D [2]. Until introduction of the ICRU-defined *operational quantities* in 1985, beta doses were recorded as millirad. Because the quality factor for electrons (beta particles) was set at 1, the absorbed dose values are considered numerically equivalent to dose equivalent (ICRU 1993).

6.2.3 Neutron Measurement Quantities

The basis for comparison for neutron radiation is complex because, historically, the calibration of dosimeters to measure neutron dose was based on different dosimetric quantities (such as first collision dose and multiple collision dose). However, the *neutron dose equivalent* specified by the National Council on Radiation Protection and Measurements (NCRP) has been used since 1971. Evaluation of the numerical difference in comparison with the $H_P(10)$ dose used in DOELAP performance testing is used to establish relative values of the dose conversion factors for the dose quantities in conjunction with characteristics of the neutron dosimeter response characteristics and workplace radiation fields.

Dose reconstructors should convert recorded neutron dose to $H_P(10)$ using the bias values that appear in Table 6-1, and use the Deep-Dose-Equivalent-to-Organ-Dose conversion factors from Appendix B of NIOSH (2006b) to calculate the appropriate organ doses.

6.3 DOSE RECONSTRUCTION PARAMETERS

Overall accuracy and precision of the original recorded individual worker doses and their comparability to be considered in using NIOSH (2006b) guidelines depend on the following factors (Fix et al. 1997; Fix, Wilson, and Baumgartner 1997):

- Administrative practices adopted by facilities to calculate and record personnel dose based on technical, administrative, and statutory compliance considerations.
- Dosimetry technology, which includes physical capabilities of the dosimetry system such as the response to different types and energies of radiation, in particular to mixed radiation fields.
- Calibration of monitoring systems and similarity of the methods of calibration to sources of exposure in the workplace.
- Workplace radiation fields that could include mixed types of radiation, variations in exposure geometries, and environmental conditions.

Examination of the beta and photon (X- and gamma rays) radiation type, energy and geometry of exposure in the workplace, and characteristics of the dosimeter response is crucial to assessment of

Table 6-1. NTS external dosimetry—1951 to present (DeMarre 1993; Allen and Schoengold 1995; Bechtel Nevada 2001).

Photon- beta dosimeters									
Dates	Operation	Dosimeter	Description	Issue and exchange	Measurement quantity	Bias	GSD	MDL	MMD
1/27/51– 2/6/51	Ranger, 1/27/51– 2/6/51	DuPont 552 Packet	DuPont 552 packet, including: Type 502 low-range element (0.05 to 10 R) Type 510 high-range element (5 to 50 R) Brass/cadmium filters, 0.020-in. thick (symmetrical coverage on both sides with open area) (Shipman et al. 1951)	Issued to personnel who entered radiation areas and air crews. Exchanged daily. Supplemented with self-reading pocket dosimeters for exposure control. (Sometimes under-responded relative to film.)	Photon: <i>Exposure</i>	1.1	1.23 ^a	40 mR	5.0 R
10/22/51– 11/29/51	Buster– Jangle, 10/22/51– 11/29/51	DuPont 553 Packet	DuPont 553 packet, including: Type 502 low-range element (0.02 to 10 R) Type 510 high-range element (5 to 50 R) Type 606 high-range element (10 to 300 R) Brass/cadmium filters, 0.020-in. thick (symmetrical coverage on both sides with open area). Lead filters, 0.020-in. thick, possibly used with badges issued to Camp Desert Rock personnel (Kean 1951; Shipman et al. 1951; Storm 1951)	Issued to personnel who entered radiation areas, air crews, and people with potential for exposure from experiments. Exchanged daily Self-reading pocket dosimeters sometimes used. Badges for Camp Desert Rock personnel were exchanged following deployment	Photon: <i>Exposure</i>	1.1	1.23 ^a	40 mR	5.0 R
4/1/52– 6/5/52	Tumbler– Snapper, 4/1/52– 6/5/52	DuPont 558 Packet	<u>Nevada Proving Ground Personnel</u> DuPont 558 packet, including: Lead filters, 0.028-in. thick, symmetrical on both sides (except first test - ABLE) Type 508 low-range element (0.01 to 6 R) Type 1290 high-range element (20 to 3000 R) (Brady and Nelson 1985)	Issued to NPG test participants. Exchanged daily	Photon: <i>Exposure</i>	1.6	1.23 ^a	40 mR	5.0 R
		DuPont Type 502	<u>Debris cloud sampling pilots</u> LASL badge Type 502 low-range element (0.02 to 10 R) Brass/cadmium filters, 0.020-in. thick (symmetrical coverage on both sides with open area)	Exchanged daily	Photon: <i>Exposure</i>	1.4	1.19 ^a	40 mR	5.0 R
1953–June 1960	All of NTS Upshot– Knothole, 3/17/53– 6/4/53	DuPont 559 Packet	DuPont 559 Packet, including: Type 502 low-range element (0.02 to 10 R) Type 606 high-range element (10 to 300 R) Lead filters, 0.028-in. thick (symmetrical coverage on both sides with open area) (Brady and Nelson, 1985; Collison 1953)	Exchanged daily (Exposures might have included prompt radiation, including neutrons.)	Photon: <i>Exposure</i>	0.9	1.28 ^a	40 mR	5.0 R
	All of NTS Teapot, 2/18/55– 5/15/55		DuPont 559 packet, including: Type 502 low-range element (0.02 to 10 R) Type 606 high-range element (10 to 300 R) Lead filters, 0.028-in. thick (symmetrical coverage on both sides with open area) (Collison 1955)	Issued to essentially all test participants. Exchanged daily (Exposures might have included prompt radiation, including neutrons.)	Photon: <i>Exposure</i>	0.9	1.28 ^a	40 mR	5.0 R
	All of NTS Plumbob, 4/24/57– 10/07/57		<u>Nevada Test Organization</u> DuPont 559 packet, including: Type 502 low-range element (0.02 to 10 R) Type 606 high-range element (10 to 300 R) Lead filters, 0.028-in. thick (symmetrical coverage on both sides with open area)	Exchanged monthly and following radiation area work.	Photon: <i>Exposure</i>	1.0	1.19 ^a	40 mR	0.240 R
Photon- beta dosimeters									

Dates	Operation	Dosimeter	Description	Issue and exchange	Measurement quantity	Bias	GSD	MDL	MMD
	All of NTS, Plumbob, 4/24/57–10/07/57		<u>Camp Desert Rock personnel</u> DuPont 559 Packet, including: Type 502 low-range element (0.02 to 10 R) Type 606 high-range element (10 to 300 R) Aluminum, copper, and tin/lead laminate filters with open area.	Exchanged at various intervals.	Photon: <i>Exposure</i>	1.0	1.19 ^a	40 mR	5.0 R
	All of NTS Hardtack 2, 9/19/58–10/30/58		DuPont 559 packet, including: Type 502 low-range element (0.02 to 10 R) Type 834 high-range element (5 to 800 R) Lead filters, 0.028-in. thick (symmetrical coverage on both sides with open area). Packet and filter enclosed in 0.004-in.-thick plastic bag.	Exchanged monthly and on exit from radiation areas if ≥ 100 mR was suspected.	Photon: <i>Exposure</i>	1.0	1.19 ^a	40 mR	5.0 R
July 1960–1965	All of NTS Dominic II (Sun-beam), 7/7/62–7/17/62	DuPont 301-4 Packet (Also known as DuPont Type 556)	DuPont 301-4 packet, including: Type 508 low-range element (0.03 to 5 R) Type 834 high-range element (5 to 800 R) Lead filters, 0.028-in. thick (symmetrical coverage on both sides with open area) Packet covered with 0.004-in.-thick plastic bag.	Exchanged monthly for general exposures and on exit from radiation areas for exposures likely to exceed 100 mR.	Photon: <i>Exposure</i> ^d	1.0	1.23 ^a	Photon: 40 mR	Photon: 240 mR
1966–Feb. 1971	All of NTS	DuPont Type 556 Packet	DuPont Type 556 film pack Type 508 (519 also referenced) low-range element (0.03 to 5 R) Type 834 high-range element (10 to 1,000 R) Four-area filter described: tantalum-cadmium, tantalum, Teflon, open With fast neutron pack, dosimeter was sensitive to mixed fields with thermal and fast neutrons, X-rays, beta, and gamma	Exchanged monthly for general exposures and on exit from radiation areas for exposures likely to exceed 100 mR.	Photon: <i>Exposure</i> Beta: <i>Absorbed dose</i> ^c	1.0	1.23 ^{a,b}	Photon: 40 mR Beta: 40 mrem ^e	Photon: 240 mR Beta: 240 mrem
March 1971–1986	All of NTS	Kodak Type III	Low-range element (0.03 to 10 R) High-range element (10 to 800 R)	Exchanged monthly for general exposures and on exit from radiation areas for exposures likely to exceed 100 mR.	Photon: <i>Exposure</i> Beta: <i>Absorbed dose</i> ^c	1.0	1.23 ^b	Photon: 30 mR ^f Beta: 30 mrem ^f	Photon: 180 mR Beta: 180 mrem
1970–1972	NRDS	Pan Am TLD	Two-element LiF, Type 700	Quarterly	Photon: <i>Exposure</i> Beta: <i>Absorbed dose</i> ^c	0.8	1.23 ^b	Photon: 15 mR ^g Beta: 15 mrem ^g	Photon: 30 mR Beta: 30 mrem
1987–Present	All of NTS	Panasonic 802	Four-element TLD – two Li ₂ B ₄ O ₇ :Cu chips and two CaSO ₄ :Tm chips. Filtration provided to determine gamma, deep dose, shallow dose, beta, and eye dose. NTS badge holder used from 1987. Used for beta gamma only.	Quarterly	<i>Personal dose equivalent, H_p(d)</i> ^h	0.9	1.23 ^b	Photon: 30 mrem Beta: 25 mrem	Photon: 60 mrem Beta: 50 mrem

Photon- beta dosimeters									
Dates	Operation	Dosimeter	Description	Issue and exchange	Measurement quantity	Bias	GSD	MDL	MMD
2001–present	All of NTS	Panasonic 809 combination dosimeter	Multielement TLD containing four elements. E1 - gamma-sensitive ${}^7\text{Li}_2{}^{11}\text{B}_4\text{O}_7(\text{Cu})$, enriched to 99.99% in ${}^7\text{Li}$. E2, E3 and E4 – neutron-sensitive ${}^6\text{Li}_2{}^{10}\text{B}_4\text{O}_7(\text{Cu})$ chips. Li-6 enriched to 95.33% and B-10 enriched to 94.64%. Elements are shielded with tin and cadmium on front and back, in various combinations. Issued for mixed beta, gamma, neutron.	Quarterly	<i>Personal dose equivalent, $H_p(d)^h$</i>	0.9	1.23 ^d	Photon: 30 mrem ^g Beta: 25 mrem ^g	Photon: 60 mrem Beta: 50 mrem
Neutron dosimeters									
1961–1979	Areas and operations where the potential for neutron exposure existed	Kodak NTA	Responds to neutrons with energies above 0.8 MeV; range under near-ideal conditions 0.1 to few rem of neutrons; high gamma doses might mask neutron tracks	Exchanged monthly for general exposures and on exit from radiation areas for exposures likely to exceed 100 mR.	<i>Dose equivalent</i>	0.5. ^l	1.52 ^b	100 mrem ^{i,k}	600 mrem
1979–1986		Albedo Dosimeter	Hankins-type albedo dosimeter. Consists of four pairs of TLD-600 and TLD-700 (${}^6\text{LiF}$ and ${}^7\text{LiF}$) in cadmium pillbox for thermal neutron suppression. High sensitivity to low-energy neutrons, with decreasing response as energy increases.	Monthly Issued only to individuals with potential for exposure to neutrons	<i>Dose equivalent</i>	1.0. ^l	1.23 ^b	20 mrem ^{i,j}	120 mrem
1987–2000		TED	Three pieces of CR-39 plastic used to detect neutrons with energies above 100 keV.	Quarterly, except for limited number of workers (radiographers, well loggers, and personnel routinely entering HRAs). Issued only to individuals with potential for exposure to neutrons	<i>Dose equivalent</i>	0.9 ^j	1.23 ^b	50 mrem ^{i,k}	100 mrem
2001–present		Panasonic 809 combination dosimeter.	Multielement TLD containing four elements. E1 - gamma-sensitive ${}^7\text{Li}_2{}^{11}\text{B}_4\text{O}_7(\text{Cu})$, enriched to 99.99% in ${}^7\text{Li}$. E2, E3 and E4 – neutron-sensitive ${}^6\text{Li}_2{}^{10}\text{B}_4\text{O}_7(\text{Cu})$ chips. Li-6 enriched to 95.33% and B-10 enriched to 94.64%. Elements are shielded with tin and cadmium on front and back, in various combinations. Includes CR-39.	Quarterly, except for limited number of workers (radiographers, well loggers, and personnel routinely entering HRAs). Issued only to individuals with potential for exposure to neutrons	<i>Dose equivalent</i> ^h	1.0. ^j	1.23 ^b	40 mrem ^{i,k}	80 mrem

- Based on uncertainty values provided by NRC (1989) and ORAUT (2008b, Equation 4-1) for the 95th-percentile estimate.
- Based on an assumption favorable to claimants of a sigma (standard deviation) equal to $\pm 20\%$ and 95th-percentile values enveloped by 2 sigma.
- Numerically equivalent to *dose equivalent* ($Q = 1$).
- A contribution amounting to 25% of the total dose should be included for all energy ranges to account for low-energy photons attenuated by the lead filter that covered a portion of the film (Kathren, 2004).
- Assumed to be the same as that for DuPont Type 502 and 508 films (NRC 1989).
- From DeMarre (2002).
- Assumed to be the same as Panasonic 802 dosimeter.
- Deep dose equivalent* = $H_p(10)$.
- Source: NCRP (1971).
- See discussion in Section 6.4.3.1.
- Based on reported values, corrected for potential energy-dependent under-response (NTA film and Panasonic TED) and ratio of the conversion coefficients for *personal dose equivalent, $H_p(10)$* , to those for *dose equivalent, H* , (NCRP 1971) in the 100–2,000 keV energy range.

bias and uncertainty of the original recorded dose. Table 6-1 lists the chronology of NTS external dosimetry methods and practices beginning in 1951. The parameters of significance are the bias, uncertainty, minimum detectable level (MDL), and potential maximum missed dose (MMD). For the purpose of this document, Bias is defined as the ratio of the reported dose to the true dose (i.e., if the reported dose was an overestimate of the true dose, Bias >1). The values of uncertainty are presented as the geometric standard deviation (GSD). The values of Bias and GSD for the period from 1951 to 1966 are based on the values of bias and uncertainty reported in *Film Badge Dosimetry in Atmospheric Nuclear Tests* (NRC 1989) for the dosimetry systems and practices in use during the period of atmospheric testing.

The bias factors listed in Table 6-1, are the factors by which recorded values in the dosimetry records should be *divided* to provide the best estimate of the measurement quantity [3]. The value of the measurement quantity should then be multiplied by the dose conversion factors in Appendix B of NIOSH (2006b) to obtain the organ dose [4]. The bias values for neutrons include an estimate of potential under-response due to the inherent energy response of the detector and spectral differences between the calibration sources and operational spectra. Potential detector over-response (e.g., for TLD albedo dosimeters) maintains favorability for claimants.

The uncertainty in the best estimate of the measurement quantity is accounted for in the GSD. The GSD is discussed in more detail in ORAUT (2008b) and defined in Equation 4-1 of that document presented as follows:

$$GSD = \left(\frac{95th\ percentile}{50th\ percentile} \right)^{\left(\frac{1}{1.65585} \right)} \quad (6-1)$$

Bias and uncertainty for current DOE dosimetry systems are well documented for $H_p(0.07)$ and $H_p(10)$ under DOELAP (DOE 1986a,b, 1995a). The performance of current dosimeters can be compared to performance characteristics of historical dosimetry systems in the same, or highly similar, workplaces. In addition, current performance testing techniques can be applied to earlier dosimetry systems to achieve a consistent evaluation of those systems. Dosimeter response characteristics for radiation types and energies in the workplace are crucial to the overall analysis of error in recorded dose.

The MDL is typically established at the point where the laboratory uncertainty of the readings at the 95% confidence level is $\pm 100\%$ in normal distribution terms. The MMD is equal to one-half the MDL multiplied by the number of exchange or monitoring periods (NIOSH 2006b). With an MDL = 0.04 R, and 250 monitoring periods (5 days \times 50 weeks), the MMD = $0.04/2 \times 250 = 5$ R.

6.3.1 Administrative Practices

When the testing program at NTS began in January 1951, the Los Alamos Scientific Laboratory [now named Los Alamos National Laboratory (LANL)] was responsible for administering the external dosimetry program (Allen and Schoengold 1995). While contractor organizations and the military were involved in issuing and collecting badges for some of the early operations at NTS, LANL performed calibration, processing, and interpretation work (Allen and Schoengold 1995). In July 1955, REECo assumed responsibility for most onsite radiological safety functions (Allen and Schoengold 1995).

Until 1966, there was no determination of shallow or skin dose from the film badges (DeMarre 2002; Allen and Schoengold 1995). With the introduction of a new multi-element film dosimeter in 1966 until the conversion to TLDs in January 1987, the open window (OW) was used to make a separate determination of shallow dose and deep dose (Brady and Iverson 1968; DeMarre 2002; Allen and Schoengold 1995). Shallow dose was determined by comparing the OW and closed-window readings

and, therefore, did not include the penetrating photon component. This same type of determination was used for TLDs used by Pan Am at the NRDS from 1970 to 1972 (Pan Am 1967; Boone, Bennett and Adams 1970). On the NV-185 form used for dose records at NTS, the shallow dose was incorrectly called the "Skin of the Whole-Body" dose when it was, in fact, only the beta and low-energy photon components. Beginning in 1987, procedures used currently for calculating shallow or skin dose were adopted (Allen and Schoengold 1995).

Beginning in 1987, with the introduction of Panasonic TLDs, the deep (or whole-body) dose and the shallow (or skin) dose were reported, but the shallow dose included the penetrating photon component and can therefore be considered the total skin dose (DeMarre 2002; Allen and Schoengold 1995).

Prior to 1987, unexposed control films were processed together with the personnel dosimeters [5]. Two sets of control films were used. Personnel films were processed together with two unexposed films from the same emulsion series that had been stored at the Dosimetry Laboratory in Mercury. Additional unexposed "area" films that had been stored at the NTS issue locations (Table 6-2) were processed as well. Additional badges could be obtained at Building 1000.

Table 6-2. NTS film badge issue locations (REECo 1961).

Area	Building
Mercury	111, 155
Yucca and Frenchman's Flats	CP-2
12	Rad-safe trailers and stations
400	Rad-safe stations
401	Rad-safe stations

Readings from the Mercury control films were subtracted from the dosimeter readings to obtain a net reading for determining exposure (REECo 1961, 1962). The net reading represented the occupational exposure plus the differential between the Mercury and work area environmental levels. If there was an indication that there had been a problem with use or storage of the films at the issue locations, the "area" controls were used for background subtraction. However, such incidents were rare, and were noted in the dosimetry records when they occurred.

It is important to note that, before 1986, the film badge was used for the dose of record. If the film badge was lost or damaged, the health physicists preferred to use cohort dosimetry results and ambient radiation levels. Pocket dosimeter results could be a consideration, but they were only used for short work periods and might not have been dependable because they were potentially subject to discharge (DeMarre 2006a).

Beginning in 1987, with the introduction of TLDs, the procedure was continued with TLD background dosimeters (REECo 1990; Allen and Schoengold 1995).

6.3.1.1 Exposure Limits

From 1951 to 1958, the allowable external exposure limits for occupational workers at NTS were generally consistent with NCRP recommendations (Allen and Schoengold 1995). During the 1951 to 1952 test series, participants could receive up to 3 R of gamma exposure for a 13-wk period (Allen and Schoengold 1995). Pilots and crew could receive up to 3.9 R of exposure (Allen and Schoengold 1995). For the 1953 and 1955 series, workers could receive up to 3.9 R (Allen and Schoengold 1995). Beginning in 1957, the maximum permissible exposure for test participants was limited to 3 rem per 13-wk period and 5 rem per calendar year (Allen and Schoengold 1995). In 1961, the U.S. Atomic Energy Commission (AEC) Standard Operating Procedure, *Nevada Test Site Organization (NTSO), Chapter 0524, Radiological Safety* (AEC 1961), stated that the radiation exposure criteria for

NTS personnel were 3 rem per quarter and 5 rem/yr. However, with the approval of the Test Manager, an NTS worker could receive as much as 12 rem/yr. DOE (1982), *Radiological Safety*, also set 3 rem per quarter and 5 rem/yr as limits for exposure for occupational workers.

6.3.1.2 Dosimeter Exchange

The dosimeter exchange procedures evolved over the period from 1951 to 1987. From 1951 through 1954, 1-d film dosimeters were issued to personnel entering a controlled radiation exclusion (RADEX) area. The badges were collected when leaving that area. Entry to a RADEX area was not allowed without a film dosimeter (Shipman 1953). In 1955, there was a transition to a combination of 1-d, 1-wk dosimeters for working in RADEX areas. In 1956, 1-wk dosimeters were issued for exclusion areas and by December, monthly dosimeters were in use. In 1957, the regular practice was to issue monthly dosimeters. Prior to 1957, the majority of workers were not badged because their job responsibilities did not require that they enter RADEX areas.

On April 1, 1957, the issue card system came on line (DeMarre 2002). All persons entering the NTS had to have a film badge, with the correct monthly color coding on the exterior of the badge. An individual working in a RADEX area could have many more than 12 badges for the year. If the pocket dosimeter indicated a possible exposure on the work shift, the film dosimeter was pulled and replaced. From April 1957 through the end of testing, in 1992, all NTS personnel had dosimeters (DeMarre 2002). The front gate security officer would check to make sure each badge had the proper color. If not, it was necessary to go to the Badge Office in Building 1000 at the gate to get a current badge.

Until 1987, the film badges were exchanged monthly for all individuals, or on exit from radiation areas if an exposure of 100 mR or more was measured (or suspected) (Allen and Schoengold 1995). In addition to film badges, self-reading pocket dosimeters were issued to persons entering RADEX areas, which were controlled locations at which an exposure was usually expected. The purpose of issuing pocket ionization chambers (PICs) to persons entering a RADEX area was to provide an action alert.

Following the introduction of TLDs in January 1987, dosimeters were issued on a quarterly basis unless a particular job assignment indicated the need for more frequent issue and readout (REECo 1990; Allen and Schoengold 1995). Measured exposures were added to the yearly and quarterly accumulated exposures (REECo 1990; Allen and Schoengold 1995).

6.3.1.3 Dosimetry Codes for External Monitoring

Employer codes and job titles for NTS contractors [REECo, Edgerton, Germeshausen and Grier (EG&G), Holmes & Narver (H&N), and Raytheon Services Nevada (RSN)] are available to dose reconstructors on the O: Drive maintained by the NIOSH Office of Compensation Analysis and Support.

Current NTS contractors include Bechtel Nevada; Lockheed Martin Nevada Technologies, Inc.; Johnson Controls Nevada, Inc.; and Wackenhut Services, Inc [6]. Former NTS contractors included H&N (1956–1990), Fenix & Scisson of Nevada (1963–1990), EG&G (1951–1995), REECo (1953–1995), and RSN (1990–1995) [6]. EG&G had offices and shops in Las Vegas, but some EG&G workers worked at NTS for extended periods. Some REECo workers were assigned to the Tonopah Test Range (TTR); Sandia National Laboratory is the custodian of TTR dosimetry records.

The computerized external dosimetry records contain the codes listed in Tables 6-3 and 6-4 (DeMarre 2003). Body part codes can be found in Table A-2 of ORAUT (2008c). However, the important body

part codes for external dosimetry are 01 WB Whole body; 02 SK Skin; 03 LH L-HAND; and 04 RH R-HAND.

Table 6-3. Type of dose codes for external dosimetry.

Code	Definition
00000001	Dose type unknown
00000002	Gamma
00000003	Beta
00000004	Thermal neutron
00000005	Other neutron (other than thermal)
00000006	Body part-1
00000007	Body part-2
00000008	Initial gamma ^a
00000009	Initial neutron ^a

a. Refers to initial radiation at the time of detonation, and not normally used for workers since they were not present at the time.

Table 6-4. Film damage and irregularity codes.

Damage code	Description
A	Lost dosimeter
B	Light damage
C	Heat damage
D	Pressure damage
E	Factory damage
F	Processing damage
G	Medical exposure
H	Non-personnel exposure X-ray
I	Destroyed
J	Water damage
K	Age damage
L	Undetermined damage
N	Occupation damage
O	Non-returned
X	Dose by investigation
Y	Late return

Additional information regarding recordkeeping practices during the period from 1945 to 1962 can be found in DeMarre (2006b).

6.3.1.4 Duplicate Dosimetry Records

Dosimetry for workers at NTS presents a particular problem for dose reconstruction because of the large number of DOE facilities where workers were involved with NTS activities. The standard operating practice at NTS called for wearing only the NTS personnel dosimeter (film or TLD) while on site (REECo 1995a). This posed no problem for NTS contractor employees assigned to the site who were routinely issued personnel dosimeters that served to provide the dose of record. Visitors, contractor employees from other sites, and temporary workers were also issued NTS dosimeters if called upon to work on site (REECo 1995a). However, major laboratories such as LANL, Lawrence Livermore National Laboratory (LLNL), Sandia National Laboratories (SNL), and their contractors (e.g., R E McKee) were heavily involved in NTS activities. Such temporary assignments might be of several weeks duration, perhaps punctuated by a return home over a weekend or for a few days [7].

Normal practice called for temporary or casual workers from other AEC/DOE contractor sites to obtain their NTS personnel dosimeter/security badge at the badge house in exchange for their regular, employer-issued dosimeter and security credential. Thus, a worker on temporary assignment from, for example, LLNL would come to the main gate where they would exchange their Livermore-issued personnel dosimeter/security credentials for their NTS-issued equivalents. When the workers exited the site at the end of their temporary assignments, they would turn in their NTS-issued dosimeters in exchange for the dosimeters they had left at the badge house (REECo 1995a), [8].

This system worked well, but was not foolproof and, thus, there exists a small but real possibility that in some cases the NTS dosimeter and a dosimeter from the worker's parent facility were both worn. Such might be the case if workers were flown into or out of the alternative air strip at Yucca Flats or in Area 17, and hence did not make the badge exchange at the Main Gate. In some cases, workers might have been issued a special dosimeter by the parent dosimetry laboratory as a means of tracking a special exposure away from the home facility. This was done from time to time when the potential for a high or unusual exposure was thought to be present, and the parent facilities desired a separate measurement that, if necessary, could be processed immediately upon return from NTS. This would provide an immediate indication of the worker's exposure status. There were also occasions when Lawrence Radiation Laboratory (LRL)/LLNL personnel, for example, were provided with test dosimeters for various reasons (REECo 1995a).

As a result, some individuals would have dosimetry records maintained both at their parent laboratory's dosimetry service as well as those operated by NTS. In fact, there are cases in which duplicate records exist for the same exposure. This was particularly true in the period prior to the time that REECo assumed responsibility for NTS activities (July 1955). For example, there have been LANL-based employees who reported to NTS for the Ranger Operation or the Buster-Jangle Operation in 1951. LANL performed the dosimetry for NTS for those two operations and there are copies of the same data in both the LANL and NTS record systems [9].

There were a few instances in which personnel wore duplicate dosimeters [9]. Although care was taken to avoid duplicate dose assignment, the obvious problem associated with double-badging is that the individual could be assigned the same dose twice. While this is favorable to claimants, it could result in a situation in which the unearned dose assigned to an individual might be sufficient to result in an unduly and inappropriately high POC leading to unwarranted compensation.

In situations where an employee of one of the laboratories obtained an exposure that appears in the NTS records system, the dose reconstructor should review laboratory records for the same period to determine if the same exposure for the same period appears in those records as well. If so, a note should be made that the exposure was received at NTS, and the exposure appearing in laboratory records should not be included.

Double-badging and associated doubled dose assignments are likely to be difficult to establish with any degree of certainty. Unless there is unequivocal documentation that two badges were issued and that two doses were assigned for the same period, the prudent action would be for the dose evaluator to assign all recorded dose to the claimant. However, if two personnel dosimeters were assigned to the same person and both were worn over the same or approximately the same period with approximately the same recorded dose, this is *prima facie* evidence that the person was in fact double-badged and highly suggestive that a doubled dose assignment was made. In such instances, a determination should be made whether this was likely the case. If so, only the higher of the doses from the two dosimeters should be assigned to the claimant.

Similarly, if documentation exists that a person was in fact double-badged, with the time frame for one badge overlapping the time frame for the other badge at both ends, the dose from the former dosimeter should be assigned unless it is the smaller of the two. This is illustrated by the following

hypothetical example: Worker ABC was issued a personnel dosimeter on January 15, 19xx, by his parent facility and another by NTS on January 20, 19xx. The NTS dosimeter was turned in on January 30, 19xx, and from it a dose of 400 mrem was assigned. The dosimeter from the parent facility was turned in on January 31, 19xx, and indicated a dose of 600 mrem. Documentation indicates that both badges were worn or carried on the person while at NTS. In this case, the claimant should be assigned a dose of 600 mrem for the period from January 15 through January 31. If it cannot be established that both dosimeters were worn or carried while at NTS, the readings from both dosimeters should be assigned to the claimant.

An additional concern arises because there were some REECo employees who were hired and terminated at NTS, but who were assigned to offsite locations. For example, REECo employees were assigned to support SNL at TTR, a situation that was possible until the mid-1990s [10]. Dose reconstructors should be aware that the only records NTS would have are the dosimetry results for the in- and out-processing period (usually 1 d each). If mention is made of working at TTR, the dose reconstructor might need to request additional information from SNL (e.g., either the dosimetry data or a clear statement that the employee was not monitored). If the TTR employment was not verified by DOL and no dosimetry records for TTR are included in the file, the TTR employment should not be included in the dose reconstruction and the entire period of DOL-verified employment should be evaluated as NTS employment.

6.3.1.5 Special Issues

6.3.1.5.1 External Exposure to “Hot Particles”

Highly radioactive particles are produced by some of the operations at NTS (e.g. atmospheric testing or reactor operations such as the nuclear rocket tests) (NRDL 1968; NCRP 1990). The size of hot particles contained in nuclear fallout ranges from 10 nm to 20 µm for the worldwide fallout (NCRP 1990). Local fallout particles are significantly bigger (100 µm to several millimeters) (NCRP 1990). When deposited on skin or clothing, they can produce high levels of localized exposure, primarily from beta or alpha particles (NRDL 1968; NCRP 1990).

Hot particle exposure is not easily identified because, in general, the dosimeter response cannot be used to distinguish between a hot particle exposure from a distributed radiation field exposure [11]. Because workers were normally monitored with hand-held survey instruments when leaving a radiation area, it was most likely that hot particles would be detected during this monitoring process (Rollins 2007). If such particles were detected, the worker would be asked to go through a decontamination procedure, including removal of outer clothing and showering as necessary (Allen and Schoengold 1995, Rollins 2007). However, it is not likely that such incidents would be entered in the dosimetry record unless the conditions were unusual (e.g. very high count rates).

Unless hot particles are detected shortly after deposition using survey instruments, they will be removed by normal washing or change of clothes, and their exposure will not be recorded. Without a specific entry in the dosimetry record, the only evidence, if the hot particle exposure is high enough, could be subsequent formation of a lesion at the deposition site [12].

The dose reconstructor should be aware of the possibility of external exposure from hot particle deposition and document positive indications in the claimant's dose or medical record that can be reasonably associated with hot particle deposition. Hot particle deposition issues should be addressed consistent with project guidance on assigning shallow dose.

6.3.1.5.2 Intentional Nonuse of Dosimeters

There is anecdotal evidence suggesting that workers might have intentionally failed to wear their dosimeters during specific operations that could have caused them to exceed administrative limits [13]. This was said to have been done to avoid administrative actions that, *inter alia*, could have had adverse financial impact such as loss of overtime pay. There are no documented instances of this occurring (Rollins 2007), however, the practice could have taken place. In such situations, cohort dosimetry would be of questionable value because other members of the cohort are likely to have taken the same action. Dose reconstructors are encouraged to be aware that intentional nonuse of dosimeters could have taken place, and any indication of such occurrences should be documented in the claimant's file. It should be noted that, because the personnel security credential holder (identification badge) was required for entry into controlled areas, workers needed to have their dosimeters with them, limiting their ability to avoid wearing the dosimeter.

6.3.2 Individual Monitoring Methods

The dosimetry methods employed initially at NTS were adopted from techniques implemented at LANL from the beginning of the atmospheric weapons testing program (NRC 1989; Boone, Bennett, and Adams 1970). As the various atmospheric test series progressed, dosimeter configurations improved in relation to the radiation fields encountered, and the responsibility for dosimetry programs was delegated among the participating agencies and military organizations [14]. In 1955, the site contractor, REECo, assumed responsibility for most onsite radiological safety functions; this included a site-wide service based on the use of film dosimetry for photons, betas, and neutrons. These methods evolved and eventually gave way to other methods including TLD and nuclear track detection or track etch detectors (TEDs) (Allen and Schoengold 1995; DeMarre 2002). From the beginning, PICs were used if necessary to augment the passive dosimeters issued to NTS workers and visitors. More detail on the Dosimetry Technology associated with the monitoring methods used at the NTS can be found in Attachment A.

6.3.2.1 Beta/Gamma Dosimeters

The film dosimeter issued for the first test series at the NTS in 1951 – Ranger – was a DuPont 552 packet, which included two films: a Type 502 low-range component (0.05 to 10 R) and a Type 510 high-range component (5 to 50 R). Brass/cadmium strips, 0.020-in. thick, provided symmetrical filtration on both sides of the film, with the remainder of the film open and unfiltered (Shipman et al. 1951).

A modified dosimeter was used by both the Nevada Proving Ground (NPG) and Desert Rock Rad-Safe groups for the second NTS series in 1951 – Buster-Jangle (NRC 1989). The DuPont 553 dosimeter included a third, higher range film component – Type 606 (10 to 300 R) (Kean 1951; Shipman et al. 1951; Storm 1951). NPG film packets were used in the Los Alamos brass-cadmium badge with 0.020-inch-thick brass and cadmium filters plus an open window. Desert-Rock film packets were in sealed, clear plastic envelopes, and probably had 0.020-inch-thick lead filters, as were used a few months later at NPG during operation TUMBLER-SNAPPER (Kean 1951; Shipman et al. 1951; Storm 1951).

The film dosimeter used by the NPG personnel for Tumbler-Snapper was designated DuPont 558 packet. With the exception of the first test, ABLE, it included lead filters, 0.028-in. thick, symmetrical on both sides; a Type 508 low-range component (0.01 to 6 R); and a Type 1290 high-range element (20 to 3000 R) (Brady and Nelson 1985).

The use of DuPont 559 dosimeters began in 1953 and continued to July 1960. It consisted of a Type 502 low-range component (0.02 to 10 R), and a Type 606 high-range element (10 to 300 R). Lead

filters, 0.028-in. thick, were used to provide symmetrical coverage on both sides, leaving an open area (Brady and Nelson 1985; Collison 1953). It was used essentially unchanged until HARDTACK II in 1958, when Type 834 high range film (5-800 R) replaced the Type 606 film to provide and overlap with the Type 502 film.

The film badge dosimeter used from July 1960 through 1965 was a modification of the DuPont 559, designated DuPont type 301-4. It consisted of a type 508 low-range component (0.03 to 10 R) and a type 834 high-range component (10 to 1,000 R) wrapped with a 28-mil (0.028-in.)-thick lead strip covering an area 0.5 in. by 1 in. on each side. The remainder of the 1" x 1.5" was uncovered. The packet was in a 4-mil (0.04-in.)-thick plastic bag sealed with colored tape to indicate the month of validity. The bag was clipped to the security badge, and all personnel entering NTS wore this dosimeter (DeMarre 2002).

In 1966, NTS began using a combination personnel dosimeter and security credential holder (Brady and Iverson 1968) to provide the increased personnel dosimetry capability necessary to meet radiation exposure problems associated with nuclear rocket testing and underground nuclear detonations. The holder was designed to accommodate a DuPont type 556 film packet, a fast neutron packet [containing Kodak nuclear track emulsion, type A (NTA) film], an identification plate, criticality accident components, the security credential, and a snap-type clip. The complete package could measure beta, gamma, X-ray, thermal neutron, fast neutron, high-range gamma, and high-range neutron exposures.

In March 1971, when the use of DuPont film ended, NTS dosimetry operations converted to Kodak Type III film packets (DeMarre 2002). This two-component packet contained low-range (30 mR to 10 R) and high-range (10 to 800 R) films. The other components of the badge remained essentially the same.

The first routine use of TLDs at NTS began in 1970 (Boone, Bennett, and Adams 1970). Starting in February 1966, Pan Am used TLDs at the NRDS as part of the site effluent monitoring program (Figure 6-1) (PanAm 1967). These dosimeters contained a calcium-fluoride phosphor bound to a helically wound wire in an evacuated glass tube and were ideal for the intended purpose but unsuitable for personnel dosimetry (PanAm 1967).

With the advent of DOE requirements to restrict personnel exposures to as low as reasonably achievable (ALARA) and with emphasis on accurate dosimetry at low doses, REECO Environmental Sciences Department personnel began evaluating TLD systems and neutron dosimeters in the early 1980s to replace the film badge and neutron TLD (DeMarre 2002).

After evaluating several dosimetry systems, the Environmental Sciences Department determined that the Panasonic 802 TLD and the neutron TED were the best combination for NTS exposure conditions. These were put into use January 1, 1987 (DeMarre 2002). The security credential holder was redesigned to accommodate both dosimeters (Figures 6-1, 6-2, and 6-3).

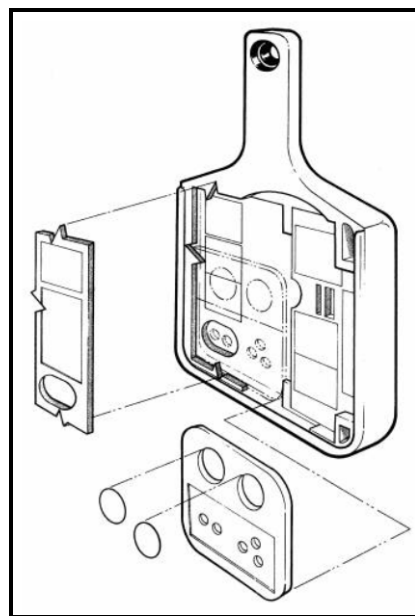

Figure 6-1. Security badge for NRDS TLD.

The four-element Panasonic UD-802 TLD was the primary dosimeter for routine use issued to all monitored personnel until 2001, when it was replaced by the Panasonic 809 dosimeter, which also contained four elements (Table 6-1). The Panasonic UD-807 TLD is used to monitor personnel

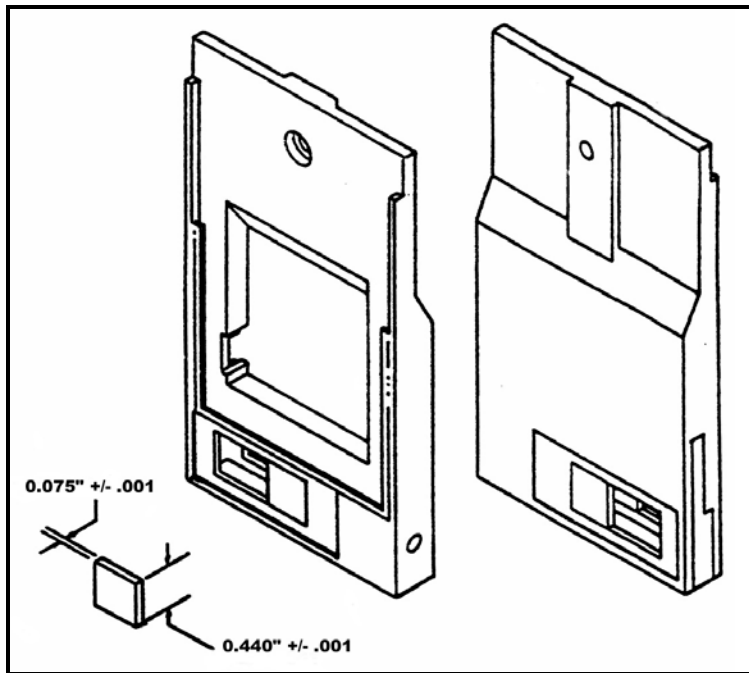

Figure 6-2. REECo badge holder (REECo 1990).

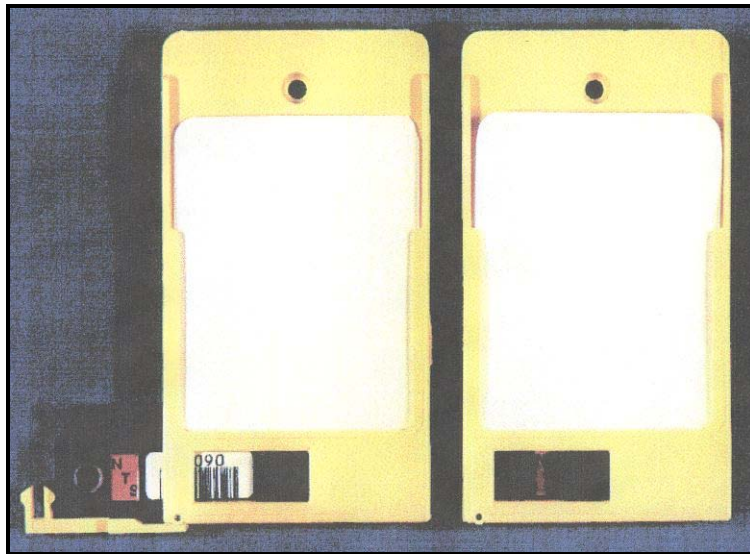

Figure 6-3. REECo security badge holder with Panasonic UD-802 dosimeter.

working in situations where the likelihood of exposure to an extremity is significantly greater than exposure to the whole body (Bechtel Nevada 2001).

In addition to film and TLD badges, self-reading pocket dosimeters were issued to persons entering controlled RADEX areas, which were controlled locations at which an exposure was usually expected (DeMarre 2002). The maximum reading on the pocket dosimeters most commonly used was 200 mrem. The pocket dosimeter could discharge when dropped, knocked, or exposed to water. Unless there was good evidence that the pocket dosimeter was damaged, a high reading of a PIC (≥ 100 mrem) triggered the action of collecting and processing the personnel dosimeter being used at the time (DeMarre 2006a). PIC results were not used unless the personnel dosimeter had somehow been compromised. The PIC result would have been included in a special investigation of the incident.

Although PIC results were only used as dose-of-record when film badge results were not available because of their typical over-response characteristics (Figure 6-4), PIC results should be evaluated carefully before including them in the dose reconstruction.

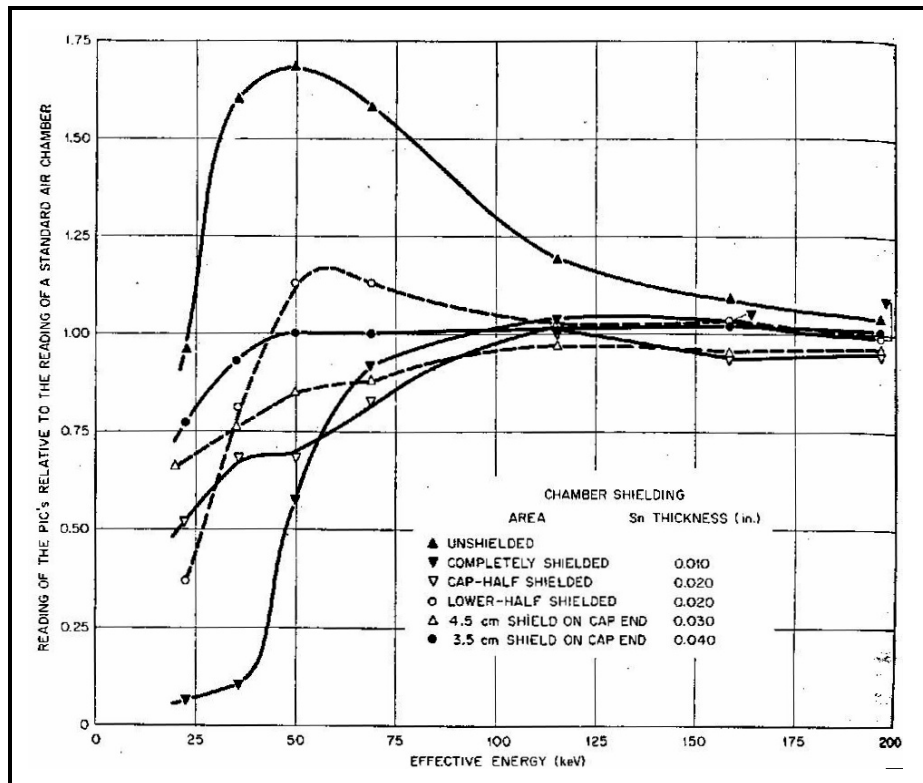

Figure 6-4. X-ray energy dependence of PICs (Sanders, Auxier, and Cheka 1959).

6.3.2.1.1 Beta Dosimetry with Film Badges

Film response to beta radiation is accomplished with an unshielded portion of a film packet. Multi-element film badges have an OW or unshielded portion that allows beta and photon radiation to reach the film. The beta dose is interpreted by removing the density attributable to a concomitant photon exposure as determined by the densities on those portions of the film under the various filters. The process is subject to large uncertainties, perhaps as much as a factor of 2 [15].

Prior to 1966, film dosimetry at NTS was performed with a bare film packet partially covered by a lead strip. The exposed film was interpreted by attributing the density under the lead filter to photons. The density in the unshielded portion of the film was assumed to be due to both photons and betas, and was typically not measured. In those instances in which the unshielded portion was read, the beta dose was determined by simply subtracting the density under the lead strip from that in the unshielded portion of the film to obtain a net density. This procedure did not accurately determine beta dose because it attributed the entire net density of the unshielded portion to beta dose, ignoring the low-energy photon dose contribution (e.g., energies less than about 80 keV, of concern primarily to post-test drillback crews before 1965 and tunnel reentry crews in those situations when the tunnel was not vented before reentry), which did not penetrate the lead strip. It is estimated that as much as 25% of the total photon dose could have been missed as a result of this attenuation (Kathren 2004; Coryell and Sugarman 1951; Nelms and Cooper 1959). Therefore, the beta dose could have been overestimated. Given the spectra and mix of radionuclides encountered at NTS, dose estimates made in this fashion are likely to be within a factor of 2 of actual beta dose (Becker 1966, p. 102; Kathren and Larson 1969) and could slightly underestimate the overall photon dose. However, such

dose estimates are likely to be unreliable and should be confirmed by other factors such as the beta:photon dose rate ratio obtained with monitoring instruments in the field, if such data are available. The value of a factor of 2 is an estimate of the range of uncertainty based on knowledge of the reported response characteristics of the dosimeters, and is presented for general information only.

Multi-element badges were introduced at NTS in 1966 (Brady and Iverson 1968; DeMarre 2002). A single high-Z metallic filter provided a more or less flat energy response for photons with energies above the uncertainty edge of the filter (about 50 keV). The density under the filter was used to assess the dose to photons above this cutoff energy and to evaluate the doses to photons with energies below the cutoff using densities under the other filters. Two filters – an OW and a low-Z material (typically plastic such as Teflon) – were used to determine the beta dose. The response of the film under these filters was approximately the same for photons, but the low-Z plastic filter essentially removed all the betas. The reading from the low-Z filter, which was considered to be attributable to photons only, was subtracted from the density under the unshielded portion, which had a comparable response to photons and also was responsive to beta radiation. The analysis can be performed manually with a set of calibration curves made at different photon energies and a beta calibration curve or with an algorithm developed from such a set of calibration curves. If it is necessary to make a beta dose estimate using the film badge results from shallow dose estimates from 1966 through 1986, dose reconstructors should double the reported value to ensure favorability to claimants and to account for uncertainties [15].

For external dose reconstruction, a positive indication of beta exposure in a dose record is considered to be due to betas with energies above 15 keV [16].

6.3.2.2 Neutron Dosimeters

A small fraction of the workers at NTS had potential for exposure to neutrons [17]. For workers with a possibility of neutron exposure, personnel neutron dosimeters were used to monitor exposure. Potential sources of neutron exposure at NTS were [17]:

1. Direct production from a nuclear detonation
2. Spontaneous fission and sub-critical multiplication in fissile materials (e.g., ^{235}U , ^{239}Pu)
3. Isotopic sources such as initiators and calibration sources
4. Reactor testing

6.3.2.2.1 Film Dosimeters

From 1961 to 1971, nuclear track emulsions in the form of Kodak NTA film packets were used for personnel fast neutron dosimetry at NTS. The NTA film packet was incorporated in the newly designed combination personnel dosimeter and security credential along with a DuPont type 556 film packet for beta photon monitoring, an identification plate, criticality accident components, the security credential, and a snap-type clip (Brady and Iverson 1968). The NTA film packet consisted of a single thick-coated film of dental size wrapped in several layers of light-tight paper. More information on NTA film can be found in Attachment A, Section A.2.1.

From 1966 to 1986, every NTS badge had a cadmium strip that provided a thermal neutron-sensitive component that was only evaluated to provide verification that there had been no incidental neutron exposure (Brady and Iverson 1968). The density under a tantalum filter was compared to the density under the cadmium-tantalum filter to ensure that they were similar (equivalent densitometer reading of less than 80 mR). Cadmium readily absorbs thermal neutrons and subsequent to the absorption emits a photon of approximately 80 keV, which is of low enough energy to result in an over-response of the film badge compared to higher and lower photon energies. This energy is in the peak of the response curve, thus low level exposures to thermal neutrons were readily detected.

6.3.2.2.2 Thermoluminescent Albedo Dosimeters

The NTS albedo dosimeters adopted in 1979 were based on the design of Hankins (1977). They were used until 1987 and consisted of four TLD chips each of ^6LiF and ^7LiF , placed in a cadmium box to suppress response to thermal neutrons. Albedo neutron dosimetry depends on the detection of low-energy neutrons reflected from the body (albedo neutrons) with a thermal neutron detector. Normally, a TLD with ^6LiF (TLD-600) is used to detect neutrons, while a companion ^7LiF (TLD-700) detector that is insensitive to neutrons is used to subtract the photon/beta contribution.

6.3.2.2.3 Track Etch Detectors

Gamma-insensitive Columbia Resin (CR)-39 TEDs were introduced for personnel neutron dosimetry at NTS in 1987. These were based on the dosimeter developed at LLNL (Hankins, Homann, and Westermarck 1987; Hadlock et al. 1988). The CR-39 TED offered better fast neutron (>0.1 MeV) energy response characteristics for occupational monitoring than the TLD albedo dosimeter. The response curve is relatively flat, between 0.1 and 4 MeV (Attachment A, Figure A-5). Once a foil has been properly etched, acquiring information is a nondestructive process.

6.3.2.2.4 Panasonic 809

The Panasonic 809 replaced the Panasonic 802 dosimeter in 2001 (Bechtel Nevada 2001). The 809 dosimeter contained three neutron-sensitive $^6\text{Li}_2^{10}\text{B}_4\text{O}_7(\text{Cu})$ TLD chips. This gives the dosimeter a neutron detection capability, so the use of the TED was discontinued. Photon compensation is provided by the neutron-insensitive $^7\text{Li}_2^{11}\text{B}_4\text{O}_7(\text{Cu})$ chip. The algorithm used to process the response of the four TLDs provides the neutron dose measurement. It is, in effect, an albedo detector.

6.3.2.3 Extremity Monitoring

Extremity dosimetry has been used at NTS to assess exposure to the finger, hand, forearms and even the head (on rare occasions) that might have occurred during operations in proximity to, or involving the manual manipulation of, radioactive material and radiation-emitting objects. Extremity monitoring might be required, for example, when radiation technicians were involved in handling post-test core samples.

The dosimeter (film or TLD) was worn in a position that was intended to represent the highest exposure to the extremity, usually on the inside of the wrist in the case of film, or on the finger near the finger tip. The extremity being monitored is normally identified in the dose record using the codes shown in ORAUT (2008c, Table A-2).

In 1957, extremity limits were set at 1,500 mrem/week (DeMarre 1993). The film pack used at that time was the Film badge-DuPont 559 film packet (Table 6-1). This continued until July 1960 when the use of DuPont film packet type 301-4 (also called DuPont Type 556) was adopted (Table 6-1). In 1964, the limit for extremities was set at 75 rem per quarter (DeMarre 1993). TLD finger rings for extremity monitoring were used beginning in July 1967 (DeMarre 1993).

Although the regular use of TLD finger rings was documented in 1967 (DeMarre 1993), extremity monitoring with film and, later, TLD occurred on rare occasions prior to that time (DeMarre 2006c). ConRad $^7\text{Li F}$ and Teflon discs, 1.3 cm in diameter by 0.4 mm thick were used for measuring finger and hand exposures when personnel handled radioactive material in certain NTS operations (REECo 1968). The ^7LiF and Teflon disks were protected from the light by inserting them in black plastic pouches. The pouches were affixed to the adhesive portion of "band-aids", which were attached to the fingers of the personnel being monitored. Extremity dose determined by the TLDs was not

included in the routine dose reports. Rather, they were included with the bioassay data, and a card file of extremity doses was maintained.

The current extremity monitoring dosimeter is the single-element Panasonic UD-807 TLD shown in Figure 6-5. The Panasonic UD-807 TLD is similar to a single CaSO₄:Tm element in the Panasonic UD-802 TLD. A single UD-807 TLD is sealed in a small, transparent, circular envelope embossed with the TLD serial number. Except when removed for placement in an envelope-type holder, the TLD is kept in a processing holder. The holder has a serial number identical to the number embossed on the TLD element encapsulation. All personnel monitoring, exposure checks, and calibrations are performed with the TLD in the envelope-type holder, while all processing is performed with the TLD in the Panasonic holder.



Figure 6-5. Panasonic UD-807 extremity dosimeter (Allen and Schoengold 1995).

6.3.3 Calibration

6.3.3.1 Photons

In the early 1950s, film dosimeters were calibrated to free-air exposures using ²²⁶Ra and ⁶⁰Co sources with source strengths traceable to the National Bureau of Standards (NBS), which is now the National Institute of Standards and Technology (NIST) (NRC 1989; Allen and Schoengold 1995). Exposures were quantified from inverse-square relationships over a fixed exposure interval at various distances and for exposures at fixed distances over various time intervals. Different approaches were used to compare dosimetry results, including processing badges exposed to calibration fields to badges exposed during test operations. In addition, collocated badges of different types and ionization chambers were exposed simultaneously during some test events to provide in-field calibration for realistic radiation spectra [18].

6.3.3.2 Neutrons

Neutron calibrations have been performed with isotopic sources, reactor beams, or accelerators. However, virtually all routine or practical radiation protection calibrations employ radioactive sources [19]. The preferred neutron production mechanisms are either alpha-neutron reactions with beryllium or boron, or spontaneous fission (^{252}Cf). On rare occasions, gamma-neutron reactions have been used, but the associated high-intensity gamma fields generally make them unacceptable for calibration of dosimeters and instruments that have any degree of gamma sensitivity.

Table 6-5 summarizes the properties of commonly used isotopic sources from the International Organization for Standardization (ISO 2001). Probably the first isotopic source to be used was $^{226}\text{RaBe}$ (Roberts 1937). However, its neutron production was accompanied by a high photon emission. As ^{239}Pu , ^{238}Pu , and ^{241}Am became available, they became the alpha-emitting radionuclides of choice. Because these radionuclides have similar alpha energies, the resultant neutron energies are also similar and can be considered nearly identical for radiation protection purposes. In particular, $^{210}\text{PoBe}$ has been in use at NTS for several years (DeMarre 1993). Later $^{238}\text{Pu}(n,\alpha)\text{Be}$ and ^{252}Cf sources were used (Allen and Schoengold 1995)

Table 6-5. Characteristics of ISO reference radiation radionuclide sources used for neutron dosimeter calibration.

Source	Half-life (yr)	Flux average energy (MeV)
AmBe-241 (α,n)	432.7	4.4
Cf-252 spontaneous fission	2.65	2.4
Cf-252 in 30-cm-diameter D ₂ O sphere	2.65	0.54

Occupational neutron fields at the NTS are commonly due to fission-origin neutrons. Therefore, ^{252}Cf is particularly attractive as a calibration source because it offers better inherent spectral simulation than the alpha-neutron sources. However, the unmoderated californium neutron spectrum is significantly harder than most reactor spectra. Beginning in the 1980s, spheres filled with deuterated water (D₂O) came into common use as moderators to soften the spectrum of neutrons from the ^{252}Cf source in the center (Schwartz and Eisenhauer 1980).

For some neutron dosimeters such as TLD albedos, an alternative to source calibrations is the use of operational area calibrations. This involves exposure of dosimeters on appropriate phantoms in operational areas for extended periods (hours, days, or even weeks, depending on the ambient field intensities). The reading on the dosimeter when processed is then compared with a measurement made with a reference instrument. This relationship is used to establish a calibration for that particular area. However, the use of operational area calibrations implies work areas that have sufficient field intensities, so this method was not commonly used at NTS [20].

6.3.4 Limit of Detection

6.3.4.1 Gamma Dosimeters

6.3.4.1.1 Film

The National Research Council (NRC) evaluation of *Film Badge Dosimetry in Atmospheric Tests* (NRC 1989) included evaluation of the minimum detection levels for film dosimetry used during the period from 1951 to 1962. Application of this concept to film dosimetry during atmospheric tests generally results in an MDL of approximately 40 mR, indicating that 95% of a series of exposures at 40 mR would yield readings between 0 and 80 mR. Although lower values have been cited elsewhere

(DeMarre 1993; Allen and Schoengold 1995), the NRC values are considered conservative, and they are presented in Table 6-1.

6.3.4.1.2 TLD

Panasonic UD-802 TLDs have been tested to determine their lower limit of detection (LLD). The LLD is the minimum evaluated dose equivalent for which the readout value of a dosimeter is significantly different (at the 90% confidence level) from the mean readout of unirradiated dosimeters. LLD is a detection limit based on the standard deviation of background measurements and a 5% chance of reporting a false positive value.

DOE (1986a, Chapter 3) summarizes the procedure for determining the LLD for the DOELAP personnel dosimetry systems. It provides two alternative equations to calculate LLD. Although DOE (1986a) requires determination of the LLD for accredited dosimetry systems, no performance criteria are applied to these results.

The method used to determine the LLD for the NTS personnel TLD system is consistent with the method described in DOE (1986a). The following equations are used for determining the LLD:

$$L_{D1} = 2 \left[t_p S_o + 1.75 H_o' / (1 + B)^2 \right] / \left[1 - S / (1 + B)^2 \right] \quad (6-2)$$

and

$$L_{D2} = t_p S_o \quad (6-3)$$

where:

- L_{D1} = LD where the probability of reporting a false positive or false negative result is 5%.
- L_{D2} = LD corresponding to a 5% chance of reporting a false positive.
- T_p = distribution factor for $n-1$ degrees of freedom and a probability value of 0.95 = 1.68488.
- S_o = $[\{\sum(X_{io} - H_o)^2\}/(n-1)]^{1/2}$ = standard deviation of measurement
- H_o = $H_o' = (X_{io})/n$ = mean dose value
- X_{io} = unirradiated dosimeter value background dose
- N = number of dosimeters, number of measurements
- B = bias for DOELAP categories
- S = standard deviation for DOELAP categories

The LLD is primarily a function of the standard deviation in background dose rates. Table 6-6 lists selected NTS background dose equivalent rates. The values can vary over time. However, the temporal variation has been small since the end of atmospheric testing.

Table 6-6. Background dose equivalent rates (Allen and Schoengold 1995).

Location	Dose equivalent rate (mrem/d)		
	Shallow	Eye	Deep
NTS Area 12, Camp	0.375	0.311	0.283
NTS Area 6, Building 2	0.327	0.246	0.211
NTS Area 6, Building 50	0.255	0.182	0.150
NTS Area 23, Building 650	0.271	0.199	0.168
Test Range Complex, DOD Facility	0.249	0.193	0.169
Las Vegas, REECo Highland Building	0.181	0.139	0.121
Mean dose rate	0.276	0.212	0.184
Standard deviation	0.067	0.059	0.057

Table 6-7 lists detection limits for DOELAP categories determined during the 1990 accreditation process (Allen and Schoengold 1995). The LLD used at NTS as most appropriate for its operations is L_{D2} , which is considered to be the most applicable value for determination of a dose likely to be higher than background levels and which increases the probability that a dose will be evaluated as positive. However, for dose reconstruction purposes, the major concern is reporting a false negative - reporting an exposure as zero when it really was greater than zero. Therefore, the L_{D1} values are considered to be appropriate for determination of MDL. Values of 0.3 mrem/d for deep dose and eye dose equivalents and 0.27 mrem/d for shallow dose should be used for NTS personnel TLD measurements. For a quarterly exchange period (90 d), the equivalent LLD values are 27 mrem for deep dose and eye dose equivalents, and 24.3 mrem for beta dose equivalent. Considering the conservatism of a 90-d exposure quarter, nominal values of 30 mrem for photon exposures and 25 mrem for beta exposures are recommended for dose reconstruction (Table 6-1).

Table 6-7. NTS Panasonic UD-802 detection limits for DOELAP categories (mrem/day).

Category		Shallow dose		Eye dose		Deep dose	
		L_{D1}	L_{D2}	L_{D1}	L_{D2}	L_{D1}	L_{D2}
I.	Low-energy photons-X-ray high dose	N/A ^a	N/A	N/A	N/A	0.21	0.21
II.	High-energy photons-high dose	N/A	N/A	N/A	N/A	0.21	0.21
IIIa.	Low-energy photons-X-ray general	0.31	0.13	0.23	0.10	0.23	0.10
IIIb.	Low-energy photons X-ray-plutonium environments	0.33	0.13	0.25	0.10	0.24	0.10
IV.	High-energy photons	0.28	0.13	0.21	0.10	0.21	0.10
V.	Beta particles-general	0.27	0.13	N/A	N/A	N/A	N/A

a. N/A = not applicable.

6.3.4.2 Neutron Dosimeters

Because of the energy dependence of the various personnel neutron dosimeters used at NTS (Attachment A, Section A.2), as well as other facilities throughout the DOE complex, the detection limits for neutron dosimeters are highly dependent on the operational neutron spectra encountered. The issue of operational neutron spectra is discussed in more detail in Section 6.3.5.3 and Attachment A.

6.3.4.2.1 NTA Film

NTA film has an effective energy threshold of about 0.5 MeV (Figure A-3). As a result, the limit of detection is directly proportional to the fraction of the neutron dose that is due to neutrons below 0.5 MeV (i.e., if 50% of the occupational neutron dose is due to neutrons below 0.5, the limit of detection is twice as high as it would be for a PuBe calibration source).

NTA film dosimetry is relatively insensitive when compared with other methods. Under the best of conditions, with a fast neutron spectrum such as that from an n,α source or unmoderated ^{252}Cf fission neutrons, a reasonable limit of detection is about 50 mrem (ICRU 2001). However, when the spectrum is degraded, the detection limit is increased significantly - by as much as a factor of 2 due to shielding and scatter from isotopic sources, and a factor of 5 for heavily shielded reactor operations (Section 6.3.5.3). As a result, the MDL recommended in Table 6-1 is 100 mrem.

6.3.4.2.2 TLD Albedo

TLD albedo dosimetry is inherently much more sensitive than NTA film dosimetry. However, it suffers from an adverse energy dependence, with the response decreasing seriously with increasing energy (Figure A-4). Taking into account a bias of about a factor of 2 (Section 6.3.5.3), an MDL of 20 mrem is recommended in Table 6-1.

6.3.4.2.3 Track Etch Detectors

Control foils processed with each TED processing are used as the basis for background subtraction for the TED system. The mean background dose equivalent to the control foils and the variance among the control foil dose equivalents are calculated for each processing. The background dose equivalent is determined for each processing because it can differ among foil sheets and within foils from the same sheet. Therefore, the TED background correction is not a single value, but a variable determined with each processing (Allen and Schoengold 1995; ICRU 2001).

The method for determining the LLD for the TED system, with a variable background correction, was determined from Chapter 7 of NCRP Report 58, *A Handbook of Radioactivity Measurements Procedures* (NCRP 1978). The appropriate equations are:

$$L_{D1} = 2.71 + 4.65\sqrt{V_B} \quad (6-4)$$

and

$$L_{D2} = 2.32\sqrt{V_B} \quad (6-5)$$

where:

V_B = background variance in units of dose equivalent squared (millirem squared).

The L_{D2} equation above was selected as the most appropriate LLD for the TED system. The selection reasons are the same as those discussed above for the TLD system.

The control foil variance (V_B) increases with TED foil age and typically ranges between 5 and 25 mrem. Therefore, the TED system LLD is normally between 5 and 12 mrem. However, based on practical experience with these detectors, a value of 25 to 30 mrem is more realistic. That range of limits is reasonable for any TED issue period because it is primarily dependent on foil age and is only slightly dependent on the issue period. Considering the possibility of long-term variations and other contributing factors, potential energy-dependent under-response to moderated spectra, and the ratio of $H_P(10)$ to dose equivalent H , dose reconstructors should use a value of 50 mrem for the MDL (Table 6-1) [21].

6.3.5 Workplace Radiation Fields

The radiation production characteristics at NTS have been outlined in ORAUT (2004). The potential for external radiation exposures arises primarily from the fission and activation products handled at NTS (ORAUT 2008a, Table 2-2). In addition, there is limited potential for neutron exposure from handling TRU radionuclides, isotopic sources, and reactor operations.

6.3.5.1 Photon Fields

The residual radiation field following detonation of a nuclear weapon consists of radiation from fission products, activation products, and unfissioned uranium or plutonium. During atmospheric testing of fission and fusion devices, differences in photon fields of residual radioactivity from detonations were observed. These differences are caused by the relative abundance of a few radionuclides that were produced in each atmospheric test (Hicks 1981a to 1981i). For example, a low-altitude detonation of a fusion weapon induces large quantities of activation products emitting high-energy gamma rays that dominate the residual radiation spectrum for the first few days following the detonation. In contrast, a low-altitude detonation of a fission weapon produces large quantities of fission products that emit a

wide range of photon energies. With either type of weapon, depending on the design, there can be a large amount of activity from the ²³⁹Np produced, which can dominate the spectrum for several days.

Although the residual radiation intensity depends on a number of factors that can vary from test to test, relatively few radionuclides, common to all tests, contribute to the major part of the photon spectrum. The relative abundance of each of these radionuclides determines the spectrum. In all cases, the photon field is from photons with energies between approximately 100 keV and 2 MeV. There is very little contribution from photons with energies less than 100 keV with the exception of scattering from large area sources. In those cases, the scattered radiation was determined to have an energy of approximately 75 keV and to have contributed as much as 10% of the overall photon spectrum (Kathren 2004). The special case of exposure to noble gases during post-test drilling can involve a significant contribution to photons with energies below 100 keV (Section 6.3.5.1.2).

For external dose reconstruction, if the conditions of exposure (work area, operation, etc.) are unknown, dose reconstructors should use the assumption favorable to claimants that photon energies are between 30 and 250 keV. If the exposure was due to fresh fallout (early reentry teams), it would be reasonable and still favorable to claimants to assume that 75% of the photon dose was from photons with energies above 250 keV (Kathren 2004; Coryell and Sugarman 1951; Nelms and Cooper 1959). If there is adequate documentation linking exposures to a particular NTS work area and/or operation, Table 6-9 presents guidance on a reasonable allocation of the recorded exposure or personal dose equivalent to the energy groups 30 to 250 keV and >250 keV. The information in this table is based on the radionuclide inventories presented in ORAUT (2004, Table 2-2). For more detail, see Attachment B. Prior to 1966, an additional 25% of the total dose should be included as an adjustment to account for the lead shielding described for some of the dosimeters (See Table 6-1).

6.3.5.1.1 Nuclear and Ramjet Engine Tests and Other Reactor Tests

Nuclear rocket and ramjet engine tests were conducted on NTS in Area 25 and Area 26, about 80 mi northwest of Las Vegas, Nevada, from July 1959 through September 1969 (DOE 1995b). Development of the nuclear rocket engine began in 1955 under joint sponsorship of the Air Force and the AEC (DOE 1995b). The Los Alamos Scientific Laboratory (LASL) was responsible for developing reactor technology for the nuclear rocket engine (Project ROVER) while the Air Force was responsible for the non-nuclear portion of the project. In 1960, the AEC and the National Aeronautics and Space Administration formed the Space Nuclear Propulsion Office (changed later to the Space Nuclear Systems Office) to administer development of an operational nuclear rocket (NERVA, Nuclear Engine for Rocket Vehicle Application). Such a nuclear-powered rocket was visualized for use in space travel, given the crew could be adequately protected from radiation produced by the operating engine.

In a somewhat parallel program (Project PLUTO), LRL in 1957 began development of a nuclear ramjet engine. Because this was designed as an air-breathing engine, it was visualized as being restricted to relatively low altitudes. No engine tests were conducted during 1970 and 1971. The final related reactor test was of a "nuclear furnace" with a replaceable core in a reusable test bed designed to provide an inexpensive approach to testing advanced fuels in full-scale reactor environments. The nuclear furnace was successfully tested in June and July 1972. All nuclear rocket engines and systems tests were terminated in January 1973 (DOE 1995c). During operation, the nuclear and ramjet assemblies were very well shielded with essentially no potential for external exposure of personnel (Rollins 2007). However, the maintenance that was required between runs often required hands-on manipulation that could result in significant exposure to the photon fields from fresh fission products (NRDL 1968).

Other reactor and linear accelerator tests were conducted by various agencies at NTS. Operation Bare Reactor Experiment Nevada (BREN) and Operation High Energy Neutron Reactions Experiment (HENRE) and the Super Kukla reactor operations are examples. There were many individual and

unique tests conducted at NTS and the TBD does not include a detailed account of all operations and activities. Additional information and references will be researched as appropriate as claims requiring this information are submitted.

6.3.5.1.2 Noble Gas Exposure

Exposure to significant concentrations of noble gases—isotopes of krypton and xenon—was possible following an underground test (LRL 1964; LANL 1994). While such exposure was not of concern from atmospheric tests because of rapid dispersion, certain post-test operations following an underground test carried the risk of relatively sudden exposure to large concentrations of such gases (LANL 1994). These exposures could generally occur in two ways.

Post-test drilling operations were often conducted as soon after detonation as possible. As soon as the cavity had collapsed and the crater was created, the drill rigs were brought in to begin the process of core sampling. The rig basically consisted of the drill platform, with a structure to shelter the drillers at some distance from the drill rod entry point, and a separate platform called the monkey board several feet above the platform. As the drilling progressed, new sections of drill rod were added with workers on the monkey board. Drill mud was circulated down the drill hole for lubrication. When the drill rod reached the cavity, circulation was lost as the mud entered the cavity rather than returning up the drill hole. This allowed the gases trapped in the cavity to escape up the drill hole, with the potential for significant exposure to workers on the platform and monkey board. The magnitude of the exposure would decrease with time following the detonation in proportion to the radioactive decay of the volatile radionuclides released (noble gases, halogens, etc.).

While the iodine that escaped in this way is primarily considered an internal exposure hazard, the noble gases are of concern from an external exposure standpoint, enveloping workers in a cloud, but not having significant potential for intake (LANL 1994). The primary fission product noble gas radionuclides are summarized in Table 6-8. Of these, ^{133,133m}Xe are the nuclides of primary concern. Their fission yields were large enough that they were produced in significant quantities, while their half-lives were long enough that they would still be present in significant quantities several days after the test, but not so long as to significantly reduce their specific activity, compared with the much longer lived ⁸⁵Kr.

Table 6-8. Primary iodines and fission product noble gases with half-lives greater than 1 hr (for yields ≥ 0.01 photon or beta per disintegration).

Nuclide	Half-life	Photon fractions			Average maximum beta energy (keV)	Average beta energy (keV)
		<30 keV	30–250 keV	>250 keV		
Kr-85	10.7 yr	0.0	0.0	1.000	685	251
Kr-85m	4.5 hr	0.0	0.84	0.16	839	290
Kr-87	76.3 min	0.0	0.0	1.00	3,119	1,333
Kr-88	2.84 hr	0.015	0.235	0.75	968	362
I-131	8.02 d	0.041	0.036	0.923	578	182
I-132	2.295 hr	0.002	0.186	0.812	1,320	485
I-133	20.8 hr	0.009	0.001	0.990	1,142	367
I-134	52.5 min	0.20	0.30	0.950	1,630	610
I-135	6.57 hr	0.003	0.017	0.980	944	363
Xe-133	5.24 d	0.0	1.00	0.0	346	100
Xe-133m	2.19 d	0.0	1.00	0.0	-	-
Xe-135	9.14 hr	0.0	0.97	0.03	890	301

The potential for noble gas exposure during post-test drilling was primarily limited to radiation technicians, drillers, and roughnecks. Such exposures were drastically reduced with the introduction of blow-out preventers in 1964 (LRL 1964, 1966).

Reentry after tunnel tests also had the potential for noble gas exposure to reentering miners and other crew members. Ventilation was usually introduced into tunnels following the tests to reduce the potential for such exposure prior to reentry. However, if the ventilation was not working, or had not been provided at all, the potential existed. The potential for noble gas exposure during tunnel re-entries was primarily limited to radiation technicians and miners [22].

6.3.5.2 Beta Particle Fields

This section applies only to whole-body external doses from beta radiation as could be encountered from a fallout field or residual fission product activity at a work location. It does not apply to situations in which beta radiation is deposited directly on the skin or clothing, but rather concerns in-air doses to which a worker could have been exposed. Although there is a large and highly useful body of literature pertaining to skin doses from deposition of beta-emitting contamination on the skin, less information is available on external (i.e., in-air) beta doses from fallout fields or residual fission product activity.

There are about 250 individual fission-produced radionuclides, most of which are beta particle emitters.² Many of these beta-emitting fission product radionuclides have very short half-lives—on the order of a few seconds or less—and quickly decay into other nuclides. Others decay over longer periods. Therefore, the composition and beta energy spectrum of fallout changes over time. In addition to beta-emitting fission products, activation products are produced by a nuclear detonation, although their contribution to overall beta dose is relatively small [23]. Unlike photons, which are emitted with discrete quantum energies, beta emission is characterized by a distribution of energies ranging from zero to a maximum value that is commonly used to characterize the spectrum. The average energy of a beta spectrum is typically about one-third of the maximum energy, and the total energy produced by beta particles from fission products is essentially the same as that from fission product gamma rays, namely about 7 MeV per fission (Glasstone and Dolan 1977).

In contrast to gamma rays and neutrons, whose attenuation in matter is exponential, beta rays have a finite range in matter determined by the energy of the beta particle. Because beta particles emitted by radioactive species are not monoenergetic, the range is usually specified in terms of the maximum energy of the beta particle spectrum. For the beta produced by the decay of fission and activation products, the maximum energy typically does not exceed 3 MeV,³ and the range of a 3-MeV particle in air is approximately 36 ft. Therefore, an individual at a distance greater than 36 ft from a fallout field would not receive an external dose from beta radiation associated with the decay of radionuclides produced by fission and fission-produced activation products. Similarly, an individual exposed to beta particles with energies below 70 keV would receive no beta dose to the skin because beta particles with energies below 70 keV have insufficient energy to penetrate the cornified outer layer of the skin. More details related to beta particle ranges and beta-photon ratios can be found in Attachment A, Section A.4, and Attachment C.

For external dose reconstruction, a positive indication of beta exposure in a dose record is considered to be due to betas with energies greater than 15 keV.

6.3.5.3 Neutron Fields

Table 6-9 lists areas and operations where neutron exposure could have occurred at NTS. From 1961 to 1986, fast neutron monitoring was conducted using NTA film. Personnel who did not work in

² Although the term *beta particle* can refer to both positron and negatron emission from the nucleus of an excited atom, as applied to fission-produced radionuclides it refers only to negatron (i.e., electron) emission because no known fission products emit positrons.

³ The few exceptions are fission products with very short half-lives, which can be ignored for all practical purposes.

the areas listed in Table 6-9, or were not directly involved in operations during the periods indicated were not issued personal neutron dosimeters. However, there was a thermal-neutron-sensitive component in every NTS film badge to record any indication of neutron exposure.

Table 6-9. Areas and operations where neutron exposure was possible (Allen and Schoengold 1995).

Area	Operation	Neutron sources	Beginning	Final
4 ^a	Operation BREN	Fission neutrons (Health Physics Research Reactor, HPRR)	1962	1962
5 ^b	Low-level waste site	TRU waste	1974	Present
6	Nuclear device assembly	Fission neutrons	1951	1962
25	NRDS ^c	Fission neutrons & neutron sources Cf-252, PuBe, AmBe	1959	1969
	Operation HENRE ^d	Linear accelerator	1966	1968
26 ^c	PLUTO Reactor (nuclear-powered ramjet engine)	Fission neutrons & neutron sources Cf-252, PuBe, AmBe	1959	1969
27	Nuclear explosive assembly using special nuclear material Super Kukla ^e	Fission neutrons & neutron sources Cf-252, PuBe, AmBe Super Kukla reactor	1951 1964	1992 1979
Various ^f	Down-hole well logging	PuBe-238 or Cf-252 isotopic sources	1951	Present
Various ^g	Neutron detection instrument calibration facilities	PuBe-238 or Cf-252 isotopic sources	1955	Present

- a. Auxier et al. (1963)
- b. Norton (2006)
- c. DOE (1995b)
- d. Butler and Haywood 1970
- e. DOE (2007)
- f. Demarre (1993)
- g. Demarre (2007b)

6.3.5.3.1 Weapons-Related Neutron Fields

Exposure of NTS workers to neutrons from nuclear detonations, while a theoretical possibility, was for all practical purposes nonexistent [24]. As shown in Attachment D, if an individual was more than 6 km from a detonation site, the neutron dose would have been less than 1 mrem. Strict measures were taken to ensure that personnel were not exposed to the prompt radiation from the detonation and, at the locations where personnel could have been exposed to prompt neutrons from the blast, air attenuation and similar attenuation mechanisms would have reduced the energy and the fluence of the neutrons to negligible levels. The closest workers (test personnel) were at CP-2, and later CP-1 in Area 6 (DeMarre 2006c). Therefore, dose reconstructors should ignore neutron exposure from this source unless there is evidence that the claimant was within 6 km of one or more of the atmospheric test detonation points at time of detonation. Note that CP-1 and CP-2 locations were more than 6 km from the atmospheric test locations.

Neutron exposures were possible in the vicinity of test shapes or other significant quantities of fissile materials. Plutonium pits that are not associated with high explosives are referred to as "bare pits," although all pits are sealed or encapsulated (Shipler 2004). Assembly and disassembly operations comprise the only times workers have been exposed to neutrons emanating from bare pits.

Maximum radiation dose rates occur when workers handled bare pits. Only a few individuals were associated with final assembly, arming, and firing of test weapons (Rollins 2007). Assembly operations were the only times that workers, in proximity with the weapons components, were exposed to neutrons emanating from bare pits. The operations often involve direct hands-on manipulation where the distance from the surface of the pit to the dosimeter is approximately 30 cm. Lead aprons or other shielding has been used to reduce photon dose rates. In assembly or disassembly operations, where high explosives (HE) or other materials surround the pit, photon and

neutron dose rates decrease significantly, although photon dose rates decrease more rapidly with increased shielding. Most workers involved in final assembly, arming, and firing of test weapons were national laboratory employees who traveled to NTS for these operations [25] (Rollins 2007).

The workplace neutron fields for specific types of nuclear weapons components are classified. Unclassified information on neutron spectra from nuclear weapons components is not available, but there are two sources, both with significant components above 2 MeV. Before about 1960, nuclear weapons could have contained $^{210}\text{PoBe}$ or $^{238}\text{PuBe}$ initiators (DOE 1997) with a higher neutron dose component relative to the measured photon dose. However, these were not used after 1960.

For exposures after 1960, if neutron dose information is not specifically available for those involved with final assembly and arming operations, photon exposure records, together with neutron-to-photon dose ratios can be used. The neutron-to-photon ratios can be derived from the experience at the Pantex Plant, where weapons assembly operations were conducted. Analysis of dose records for each Pantex worker where neutron and photon doses were equal to or greater than 50 mrem for the period from 1994 to 2004 yields a geometric mean of 0.8 and GSD of 1.6. An upper 95th-percentile value of 1.7 should be used for the neutron-to-photon dose ratio (ORAUT 2007a) for neutron exposures from 1961.

Assuming that 100% of the neutron doses were delivered by neutrons in the 0.1–2-MeV range is favorable to claimants. Although there are more penetrating neutrons with higher energies at NTS, the POC for deeper organs, such as the liver, is much larger, in the 0.1- 2 MeV-energy range than any other energy group, thus offsetting the higher dose at depth for the more energetic energy ranges.

6.3.5.3.2 Isotopic Neutron Sources

A more significant potential source of neutron exposure was from isotopic neutron sources such as $^{238}\text{PuBe}$ or ^{252}Cf . These sources were used in specific activities such as instrument calibration and well logging. Only a few highly trained and specialized individuals, however, had access to such sources [26].

6.3.5.3.3 Reactor Operations

The final source of potential neutron exposure was reactor test operations. These occurred in specific areas (Areas 4, 25, 26, and 27) designated for that purpose (Allen and Schoengold 1995). The number of individuals with the potential for neutron exposure was relatively small. The potential for significant neutron exposure was further mitigated by the fact that simultaneous gamma exposures were much greater and thus likely to be the governing factor for exposure control (Allen and Schoengold 1995). Neutrons were produced only during reactor operation, and personnel were always at locations remote from the reactors. Therefore, neutron exposures were low or negligible during reactor operations or test periods (Rollins 2007). Additional information on reactor operations is available in ORAUT (2004).

6.3.5.3.4 Dosimetric Characteristics of Neutron Fields

The dose from neutrons is a function of neutron fluence and neutron energy. Fewer “fast neutrons” (i.e., neutrons with kinetic energies exceeding several hundred electron volts) are required to produce a given level of dose in comparison with slow or moderated neutrons. This is reflected in the use of quality factors or neutron weighting factors applied to the absorbed dose to arrive at dose equivalent. These energy-dependent factors have changed in the last 50 yr as a result of new information on the relative biological effectiveness (RBE) of neutrons. Table 6-10 summarizes historical changes in the factors used in the United States to adjust measured absorbed doses for the higher radiological

impact associated with neutron exposures. They are shown in the neutron energy groups used in dose reconstruction.

Table 6-10. RBE, quality factors, or weighting factors for neutrons.

Neutron energy (MeV)	Dosimetry guideline ^a RBE	Quality factors ^b	Average quality factors used at NTS	Neutron weighting factor ^c w_r	Factor to be applied to NTS neutron dose
2.5E10-8	3	2	2.35	5	2
1E10-7		2			
1E10-6		2			
1E10-5		2			
1E10-4		2			
1E10-3		2			
1E10-2	10	2.5	5.38	10	2
1E10-1		7.5	10.49	20	2
5E10-1		11			
1		11			
2		10	7.56	10	1.35
2.5		9			
5		8			
7		7			
10		6.5			
14		7.5			
20		8	Not applicable	5	Not applicable
40		7			
60		5.5			

- a. Trilateral meeting in 1949 radiation protection guidelines (Fix, Gilbert, and Baumgartner 1994).
- b. Recommendations of NCRP Report 38 (NCRP 1971).
- c. ICRP Publication 60 (ICRP 1991).

The RBE was used until 1971, after which quality factors were used. The ICRU introduced the radiation weighting factor w_r in 1990 as part of its definition of $H_p(10)$. Although w_r has not been adopted in U.S. regulations, it is necessary to convert from neutron doses obtained using NCRP Report 38 quality factors to $H_p(10)$ (NCRP 1971). Figure 6-6 shows the ratio of conversion coefficients for personal dose equivalent, $H_p(10, 0^\circ)$ to conversion coefficients for dose equivalent, H (NCRP 1971). Project guidance provides conversions from radiation weighting factors for respective Interactive RadioEpidemiological Program (IREP) input neutron energy ranges.

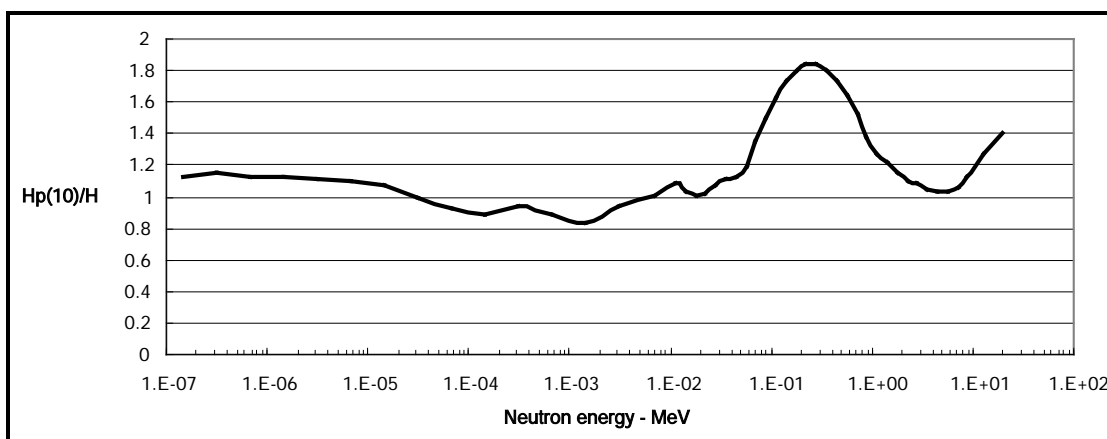

Figure 6-6. Ratio of fluence to dose conversion coefficients for personal dose equivalent $H_p(10, 0^\circ)$ to conversion coefficients for dose equivalent H

6.4 DOSE RECONSTRUCTION RECOMMENDATIONS

6.4.1 Photon Radiation

Photon radiation dose reconstruction for NTS workers requires consideration of several factors as follows:

- Determination of additional dose to unmonitored workers before the routine assignment of personnel dosimeters to all workers beginning in April 1957
- Adjustments to the reported DOE photon dose associated with the dosimeter response and radiation field characteristics
- Determination of the missed dose for monitored workers for low dose results [less than MDL of the personnel dosimeter]
- Determination of the IREP input photon radiation energy fraction
- Determination of the appropriate radiation quantities and exposure geometries to be used to determine the target organ dose

6.4.1.1 Unmonitored External Radiation Photon Dose

Assignment of dosimeters to all persons at NTS began in April 1957 and ended in December 1992 [27]. After 1992, only persons identified as having the potential for exposure were issued dosimeters; however, any person who requested a dosimeter would be assigned one. As noted above, all significantly exposed persons are expected to have been monitored (Allen and Schoengold 1995). For potentially exposed unmonitored workers prior to 1958, an estimated dose favorable to the claimant can be assigned based on the 50% dose of the monitored workers noted in the second column of Table 6-11. This provides an estimate of the potential unmonitored dose favorable to claimants, particularly if assigned for several years of employment. This dose can be adjusted during dose reconstruction to reflect the actual annual employment of the exposed person as verified by DOL. Most workers were not continuously employed at this site.

A 50th and 95th percentile dose has been calculated for the badge exchanges of persons at the NTS and is presented in Table 6-11. For an unmonitored worker with verified employment prior to 1957 the 50th percentile dose and missed dose for each month employed during the years evaluated should be assigned. Except for the 4th plutonium dispersal event (1/18/1956), there was no device testing during 1954 and 1956. Table 6-12 used in developing Table 6-11 is based on a query of the NTS historical dosimetry (1945-1983) database (DeMarre 2006d) and summaries of AEC-190 reports (1984-1992) sent to AEC/ERDA/DOE by NTS (DeMarre 2007a). The values include civilian workers and visitors and the military. An extensive review of test series measured doses may be viewed at http://www.dtra.mil/rd/programs/nuclear_personnel/atr.cfm.

6.4.1.2 Adjustments to Recorded External Photon Radiation Dose

Table 6-1 provides bias and uncertainty factors determined for the respective test series. The factors are dependent upon the radiation field specifics of the test series and the dosimeters in use. These values likely provide the most reasonable option to adjust the NTS claimant reported dose. The annual reported penetrating dose for each of the years of employment is divided by the bias (B) factors noted in Table 6-1 to arrive at the annual estimated exposure. The bias should be applied to both the reported and the missed dose, when applying the bias increases the dose being assigned.

Table 6-11. NTS calculated dose to apply as co-worker dose.^a

Year	Coworker dose (rem)	
	50% dose	95%
1945	0.001	4.251
1946	0.147	0.856
1947	0.036	0.499
1951	0.058	0.941
1952	0.106	0.665
1953	0.048	3.186
1954	0.001	0.172
1955	0.014	1.173
1956	0.026	0.323
1957	0.001	0.481

- a. Summaries of external dose measurements were provided as a dose histogram. Doses values for the 50th and 95th percentile were calculated by finding the numerical position of each percentile value within the histogram to find the correct bin. Then extrapolate to the point within the bin to calculate the dose. The method chosen to use to determine the 95th percentile and 50th percentile should be inherently favorable to claimants. It is likely the doses represented in each bin of the histogram would have been skewed towards the lower end of the bin (i.e. lognormally distributed). In the analysis it was assumed that the dose points were equally spaced between the lower and upper limits of the bin which should have resulted in a higher calculated dose.

Example:

In 1951 there were 21,086 recorded dose measurements. If the measurements were sorted from smallest to largest then the position that would represent the 95th percentile would be 20,032 (21,086 * 0.95). Knowing the position, you also know the histogram bin, which in this case is 0.500 – 0.999 rem. We now extrapolate to position 20,032 within that bin. The position number representing the bottom of the bin is 19,987 which means the 95th percentile value is in position 844.7 (20,032 – 19,987) for a bin that contains a total of 965 measurements. Extrapolation results in a dose of 0.941 rem $(844.7/965) * (0.999 - 0.5) + 0.5$.

6.4.1.3 Missed Recorded External Radiation Dose

Missed dose occurs when the dose of record is less than the MDL (i.e., considered to be zero) because the dosimeter response was less than the MDL or there is no dose of record for an assigned badge for a monitoring period. This kind of missed dose is most important for earlier years when MDLs were higher and dosimeter exchange was more frequent. Dose reconstructors should follow NIOSH (2006b) guidance and use the MDL data in Table 6-1 to calculate the missed photon dose as follows:

Missed photon dose can be assigned based on the MDL/2 method and project guidance regarding reported dose under the MDL/2, and the number of exchange periods (NIOSH 2006b) given in Table 6-1 for the dosimetry systems or the dose of record provided by DOE. For many workers, the number of dosimeter exchanges will be greater than the routine monthly exchange. The dose reconstructor should evaluate the exchange cycles and assign the appropriate number of zero cycles or default values in Table 6-1 as applicable.

6.4.1.4 IREP Input Photon Radiation Energy Fractions

Attachment B presents an inventory of the radionuclides encountered at NTS by area and operation. This information is used as a basis for estimating the IREP input fraction of the dose in each of the three energy groups—less than 30 keV, 30 to 250 keV, and greater than 250 keV. Default values are 100% 30 to 250 keV for efficiently processing a claim or 25% 30 to 250 keV and 75% greater than 250 keV. The results are presented in Table 6-13.

Table 6-12. NTS associated measured doses.^a

Lower	Dose in rem																Higher
	0	0.001	0.050	0.1	0.15	0.2	0.25	0.3	0.4	0.5	1.0	1.5	2.0	2.5	5.0	7.5	
Year	Number of persons ^b																
1945 ^c	776	8	23	31	14	24	14	23	17	94	87	22	25	157	2	10	7
1946 ^c	16	12	23	24	21	5	7	9	15	14	2	0	0	0	0	0	0
1951	6,849	2,730	5,851	1,735	537	421	382	457	225	956	311	137	49	444	2	0	0
1952	978	4,972	1,569	3,970	319	225	134	2,781	109	348	228	125	98	104	7	2	2
1953 ^b	18,746	6,351	3,448	2,134	951	1,219	592	1,295	708	3,723	2,856	202	4,305	3,266	100	9	18
1954 ^b	622	205	102	32	31	13	5	5	1	5	4	0	0	1	0	0	0
1955 ^b	16,122	4,652	1,922	3,094	595	352	325	906	1,326	3,187	1,490	407	102	292	60	2	10
1956	254	471	114	56	25	16	8	13	7	18	7	3	0	1	0	0	4
1957	42,999	9,617	9,046	5,559	2,615	2,094	1,249	1,868	1,205	2,727	676	183	98	77	9	3	4
1958	19,986	4034	3696	2119	603	527	254	462	231	380	54	27	11	2	3	3	0
1959	5,537	692	313	126	70	49	37	56	46	118	44	25	24	7	0	0	0
1960	6,820	497	205	123	44	31	18	29	14	39	21	13	4	11	1	0	1
1961	10,842	348	302	162	86	57	49	86	44	164	96	72	146	180	0	0	0
1962	15,791	838	1456	677	442	366	280	402	260	799	401	313	215	279	15	0	0
1963	16,408	358	407	222	128	99	84	107	94	188	81	28	19	25	0	0	0
1964	18,452	452	812	409	236	164	103	170	113	271	125	42	27	45	0	0	0
1965	18,527	381	758	341	219	171	128	147	97	346	200	89	40	81	4	2	0
1966	18,838	547	687	370	256	157	138	203	113	284	151	94	55	115	0	0	0
1967	18,128	630	421	226	161	109	99	127	86	206	103	57	52	39	0	0	0
1968	19,792	1158	576	260	155	88	85	134	89	203	88	50	10	7	0	0	0
1969	16,828	339	226	106	71	43	33	56	31	110	26	13	5	3	0	0	0
1970	16,595	253	257	125	74	61	41	47	41	110	34	8	3	2	0	0	0
1971	15,701	307	178	84	45	31	15	37	21	79	30	4	0	0	0	0	0
1972	91,158	414	496	290	103	42	44	46	14	8	0	0	0	0	0	0	0
1973	83,227	238	248	99	32	15	10	19	15	4	0	0	0	0	0	0	0
1974	82,441	262	264	77	18	10	11	6	5	6	0	0	0	0	0	0	0
1975	83,775	249	262	73	34	12	12	6	6	2	0	0	0	0	0	0	0
1976	79,430	151	122	32	9	5	1	3	4	2	0	0	0	0	0	0	0
1977	74,782	173	164	48	27	13	11	8	9	3	0	0	0	0	0	0	0
1978	76,949	467	224	51	19	6	2	2	1	1	0	0	0	0	0	0	0
1979	81,266	163	67	14	2	2	2	2	0	1	0	0	0	0	0	0	0
1980	93,552	565	205	33	11	5	3	1	2	0	0	0	0	0	0	0	0
1981	11,0066	286	108	27	16	7	4	5	3	4	0	0	0	0	0	0	0
1982	11,9911	222	129	32	12	4	2	3	1	0	0	0	0	0	0	0	0
1983	11,2934	190	104	33	9	3	1	2	0	0	0	0	0	0	0	0	0
1984	25,144 ^d																
1985	28,863 ^d																
1986	28,506 ^d																
1987	26,752	542		66			15			8		1		1			

Lower	Dose in rem																
	0	0.001	0.050	0.1	0.15	0.2	0.25	0.3	0.4	0.5	1.0	1.5	2.0	2.5	5.0	7.5	
Higher	0	<0.05	<0.1	<0.15	<0.2	<0.25	<0.3	<0.4	<0.5	<1.0	<1.5	<2.0	<2.5	<5.0	<7.5	<10	>10
Year	Number of persons ^b																
1988	28,060	337		45				23		2							
1989	28,198	155		29				7		2							
1990	25,213	141		32				2		2							
1991	26,239	79		18				1		2							
1992	29,559	64		12				2		1							
1993 ^e	25,429	28		5				2		2							

- a. Results of query for NTS persons from NTS historical dosimetry (1945–1983) database (DeMarre 2006d).
- b. The number of individuals is inflated for 1953-1955 because persons were counted by account number and could have more than one account number due to multiple IDs (NTS number, employee number, social security number). Dose reconstruction records are also counted (provided by DTRA for military participants) and there are visitor/vendors who were included as well. This would make the totals higher than just film badges alone.
- c. No testing occurred at NTS in 1945 and 1946, however a continental atmospheric test occurred in New Mexico as Operation Trinity. Since some of the same individuals were potentially present during later tests, the coworker data for them has been included for completeness.
- d. The DOE 190 statistics consisted of the following –
- 1984 25,144 workers and visitors between 0 and 0.999 rem with collective dose of 22.620 rem
 - 1985 28,864 workers and visitors between 0 and 0.999 rem with collective dose of 30.130 rem
 - 1986 28,521 workers and visitors between 0 and 0.999 rem with collective dose of 57.810 rem. Note: The DOE 190 data differ slightly from those in DeMarre 2006d.
- e. With the ending of testing, universal badging ended in 1992. Dosimetry was not required for any non radiation worker, however any non radiation worker requesting a dosimeter could have one assigned.

Table 6-13. NTS work area and operation-dependent photon fractions.^a

Operation	Area	Assigned fraction		
		<30 keV	30-250 keV	>250 keV
Drillback operations	1-10 and 18-20	0.03	0.50	0.47
Reentry and mineback operations	1, 12, 15, and 16	0.04	0.38	0.58
Routine tunnel operations	1, 12, 15, and	0.00	0.22	0.78
Decontamination facility	6	0.14	0.43	0.44
Treatability test facility	25	0.12	0.46	0.42
Atmospheric safety test areas	5 and 11	None indicated		
Atmospheric weapons test areas	1-5, 7-11, and 18	0.10	0.45	0.45
Low-level waste site	3	0.31	0.40	0.29
Low-level waste site	5	0.20	0.45	0.34
Radiation instrument calibration	6 and 23	0.36	0.40	0.24
Radiograph operations	23	0.00	0.23	0.76
Well logging operations	1-10 and 18-20	0.32	0.38	0.30
Nuclear explosive/device assembly	6 and 27	0.57	0.43	0.00
Nuclear rocket development	25 and 26	0.02	0.43	0.55
Radioactive source storage	6 and 23	0.26	0.41	0.33
Radiochemistry and counting laboratories	6 and 23	0.09	0.40	0.51

a. See Attachment B for derivation of partition fraction.

6.4.1.5 Determination of Radiation Quantities and Exposure Geometry

As noted in Attachments A, B, and C, the conversion coefficients for exposure and personal dose equivalent vary widely within each of the three energy groups – a factor of more than 10 for <30 eV (with a 10-keV cutoff), as much as a factor of 4 for the 30-to-250-keV group, and up to a factor of 10 above 250 keV (4,000-keV upper cutoff). The recommended dose quantities to be used in selecting dose conversion factors from the External Dosimetry Implementation Guide (NIOSH 2006b) are:

- 1951–1986: Exposure (R) to Organ Dose(HT)
- 1987–Present: Deep Dose Equivalent [$H_P(10)$] to Organ Dose (H_T)

The anterior-posterior geometry should generally be selected because higher doses are typically recorded while workers are directly working with and facing sources of radiation.

6.4.1.6 Correction Factors for External Environmental Dose

External environmental exposures, as recorded by the dosimeter, have geometries that are different from those used for dosimeter calibrations. The sources are highly extended, and isotropic in contrast with point sources placed relatively near the dosimeter for calibration. The dose assessment for external environmental exposures requires that attention be given to 1) angular or directional dependence of the dosimeter, 2) angular or directional dependence of the dosimetric quantity used for monitoring purposes, and 3) the dose of specific organs relative to the dosimeter. Environmental exposures, particularly at the NTS, are characterized by complex photon spectra due to the presence of a large number of fission and activation product radionuclides. In addition, these spectra are significantly modified by the attenuation of lower energy photons by several centimeters of intervening soil or several meters of intervening air.

The evaluation of geometric considerations and correction factors for assessment of external environmental exposures at the NTS has been addressed by Griffith (2006). The assessment included three distinct exposure geometries:

1. Exposure to ground surface contamination (infinite plane surface), characteristic of fresh fallout.

2. Exposure to soil contaminated to an infinite depth, characteristic of fallout that had been in place for several days to weeks, and had been “weathered in”.
3. Submersion in a semi-infinite cloud, characteristic of airborne radioactivity as might be encountered in a release following an underground test.

Data on the angular dependence of the dose conversion factors is taken from ICRU (1988, 1992, 1998) and ICRP (1987). Angular dependence of the dosimeters is based on dosimeter design. Although specific information for NTS dosimeters was not available, data for dosimeter of similar design was taken from results of the International Collaborative Study of Cancer Risk among Workers in the Nuclear Industry (Cardis et al. 2005; Thierry-Chef et al. 2002).

Calculations of the correction factors for organ geometry relative to the dosimeter have been performed for exposure to 1) fallout from atmospheric tests (Hicks 1981c, 1981i), 2) radionuclides released by underground test leaks (Hicks 1981a), and 3) nuclear rocket and ramjet tests (Hicks 1981a), for exposures from time of test to 50 years following the test. The radionuclide and geometry dependent dose conversion factors were taken from Eckerman et al. (1999).

Results of these calculations (Griffith 2007) show that the correction factors for external exposure environmental radiation fields found at the NTS are not significantly different from unity for most organs, and, in most cases, these values are less than 1. Given the low environmental external exposure rates at NTS, it appears that the new DCFs would not have a significant impact on the assigned environmental doses in comparison to the NIOSH dose estimates that are favorable to claimants.

6.4.2 Beta Radiation

6.4.2.1 Evaluation of Beta Exposure Geometries

In the event that personal dose records do not include estimates of beta dose, an estimate can be made from the associated photon (gamma + X-ray) exposure or dose equivalent using beta-photon ratios. The beta-photon ratios are highly variable and generally decrease with distance from the source. Three common geometries associated with beta exposures are (1) standing on a contaminated surface, (2) immersion in contaminated clouds, or (3) exposure to discrete sources (Cross et al. 1982).

To determine the best value of beta-photon to be applied to the relevant photon dose, it is necessary to clearly identify the claimant's work requirements as they relate to the most likely exposure conditions. The beta-photon values that appear in this section are given in terms of sievert beta per sievert photons. However, with a quality factor equal to 1 for beta particles, 1 Sv = 1 Gy = 100 rad. For photons, 1 Sv = 1 Gy. Because 1 Gy = 100 rad = 114 R, within the uncertainties associated with establishing beta-photon ratios, the numerical value of the beta-photon ratio can be considered valid for the period covering the NTS operations [28].

If the claimant was working in connection with the nuclear testing or the nuclear rocket and ramjet development program or if they were primarily working in areas where fission and activation products from previous operations were a significant, if not the most significant, source of exposure, data for one of the geometries primarily associated with such exposure – surface contamination or plume/cloud immersion could be used. If the claimant had work assignments at other areas of NTS, factors related to source inventories in those areas (see Attachment C) could be used.

Detailed inventories of fission and activation products following an atmospheric nuclear detonation, release of contamination following detonation, or nuclear rocket and ramjet operation are also

available (Hicks 1981a to 1981i, 1982, 1984). The development of beta-photon ratios for estimating external dose to the skin and eye from standing on contaminated surfaces or immersion in contaminated clouds is summarized in Attachment C. These values apply only to skin and eye. Separate beta/photon values for the gonads were not calculated (Kocher and Eckerman 1981; Eckerman et al. 1999) because the beta particles were not considered to contribute to the gonad dose beyond bremsstrahlung production in the soil and air (Eckerman 2006a).

No routine beta monitoring data exists for NTS prior to 1966. For the time period from 1966 to 1987, 368 data pairs were identified from 84 claim files with positive beta and gamma results (i.e., results higher than the applicable MDA). Based on these data, a lognormal distribution was calculated with a 50th percentile beta to gamma ratio of 1.04, a 95th percentile of 4.59, a geometric standard deviation (GSD) of 2.41, and a mode value between 0.5 and 1. Thus the use of the 50th percentile value on an annual basis is assumed to be reasonable, yet favorable to claimants. 42 CFR Part 82 allows claims to be completed using efficiency methods when precise estimates cannot realistically be developed due to all the variables that modify the potential for exposure to beta radiation.

6.4.2.2 Beta-Photon Ratios for Surface Contamination

External beta doses from standing on contaminated ground or other surfaces can be estimated by applying a beta-to-gamma dose ratio to an upper bound gamma dose, which is determined from film badge data or dose reconstruction. The exposure from extended contaminated surfaces is discussed in more detail in Attachment C. Table C-1 presents time-dependent beta-photon ratios for fission and activation products from detonation or time of operation to 50 yr. Based on these data, the following beta-photon ratios can be used if the exposure is presumed to have occurred for an extended contaminated surface (e.g., ground contamination from dispersal of fallout). The beta/photon ratios would be reduced by attenuation of clothing (anti-contamination clothing (e.g., coveralls), shoes, gloves, etc.), increased separation between the contaminated surface and the individual (e.g., working on an elevated structure), or any intervening material (surface coatings, floorings, etc.) and stay times. The dose reconstructor should determine if the exposure resulted from the Energy Employee walking directly on the contaminated surface, or if the job site characteristics involved non-radioactive, intervening surfaces of materials.

Information in the claim files may support the appropriateness of using the calculated values listed in Table 6-14. The ratio would be applied on a dosimeter cycle by cycle basis when there is indication in the claim file that the worker was in radiation controlled areas for a particular badging cycle.

Table 6-14. Beta-photon ratios for exposure from surface contamination.

Elapsed time following the production event	Beta/photon Sv/Sv
0 to 50 d	10
50 to 365 d	25
1 to 5 yr	60
>5 yr	25

6.4.2.3 Beta-Photon Ratios for Immersion in a Contaminated Cloud

Immersion in a contaminated fallout debris cloud was a less frequent circumstance than exposure to fallout after deposition on the ground or other surface [29]. However, exposure of workers to plumes of radioactive gas frequently occurred following releases from underground tests such as occurred during post-test drilling before gas blocking or during accidental venting (LRL 1966, LANL 1994), or could have occurred on tunnel re-entry. External beta doses from immersion in a contaminated cloud

or plume can be calculated by applying a beta-to-gamma dose ratio to an estimated upper bound gamma dose, which is determined from cycle film badge data or dose reconstruction [30].

The exposure from immersion is discussed in more detail in Attachment C. Table C-2 presents time-dependent beta-photon ratios for fission and activation products from detonation or time of operation to 50 yr. Based on these data, the beta-photon ratios shown in Table 6-15 are recommended if the exposure occurred from immersion in a contaminated gas cloud (e.g., a radioactive gas release during post shot drilling). Because the release of gases is primarily associated with weapons detonations at NTS, this geometry is recommended for drillback, reentry, and mineback operations. These ratios could be applied on a dosimeter cycle by cycle basis when there is indication in the claim records that the worker was involved in tunnel reentry or a venting incident.

Table 6-15. Beta-photon ratios for exposure from immersion in an infinite cloud of mixed fission and activation products.

Elapsed time following the production event	Beta/photon Sv/Sv
0 to 50 d	1.5
50 to 365 d	5
1 to 5 yr	10
>5 yr	5

If the exposure is known to have resulted from immersion in a plume consisting only of noble gases (krypton and xenon) and halides (bromine and iodine), the beta-photon ratios can be determined using the information in Attachment C.

6.4.2.4 Beta-Photon Ratios for Other NTS Operational Areas

If the presumed exposure was likely due to discrete sources or radioactive material with limited spatial distribution, application of beta-photon ratios associated with such exposure conditions can be used. The beta-photon ratio can be estimated from the radionuclide inventories known to be associated with a particular operation or work area. In some work situations, neither a contaminated ground surface nor immersion in a contaminated plume might adequately represent the exposure geometry. Attachment C contains detailed development of beta-photon ratios for a point-source geometry where the source is 1 m from the body surface. If sufficient information about the nature of a presumed exposure is available, more detailed calculations can be made on a case-by-case basis for individual dosimeter cycles.

6.4.2.5 Estimation of Beta-Photon Exposure

The simplest calculation is for a short-term exposure to beta and gamma radiation. The total beta plus gamma dose to the skin or lens of the eye is estimated as (Barss 2000):

$$\text{Dose skin/lens} = D(t)_{\gamma/\text{ub/fall}} [R_{\beta/\gamma}(x,t) \times M_{(x,t)} + 1] \quad (6-6)$$

where:

- $D(t)_{\gamma/\text{ub/fall}}$ = upper-bound gamma dose due to external exposure to fallout or other beta radiation field,
- $R_{\beta/\gamma}(x,t)$ = β/γ ratio = bare skin or lens beta-to-gamma dose ratio at distance x and time t ,
- $M_{(x,t)}$ = combined modifying factor that accounts for differences from the simple case of standing on contaminated ground with bare skin (e.g., attenuation by clothing, position of the body, and location above or below deck on a ship or in an aircraft) [see Barss (2000), Attachment C, Table 12], and

$D(t)_{y/ub/total}$ = upper-bound gamma dose from all sources.

Dose to skin is reduced by clothing, and Barss (2000) provides a method for determining the reduction as a function of clothing thickness. However, the corrections at a point 1 m above the contaminated surface reduce the beta exposure on the order of 20 to 30%. In view of the associated uncertainties, attenuation is also recommended consistent with project guidance on shallow dose (ORAUT 2005).

Because of the uncertainties associated with the application of beta-photon ratios to estimate potential beta exposures to NTS workers, dose reconstructors should only use these ratios when other relevant information, such as the optical density under the open area of a film badge, is not available.

If the worker dosimetry record contains no other information, including portable survey instrument results, beta-photon ratio estimates may be used with caution, recognizing that the results can be considered semi-quantitative at best, with likely errors and uncertainties in the beta dose estimate easily exceeding a factor of two. Uncertainty factors of ten, considering the lack of information, are not unreasonable [31].

6.4.2.6 Skin Contamination

For skin contamination (for example, from fallout or resuspended radioactive soil), the film badge gamma dose is a highly inaccurate indicator of skin dose, so beta-to-gamma ratios are not appropriate for such applications. However, the beta energy spectrum due to radioactive material on the surface of the skin can be determined as a function of time after detonation for each radionuclide. This allows beta doses to be directly calculated by using dose coefficients from Kocher and Eckerman (1987).

These dose coefficients are based on radionuclides deposited on or near the skin surface, and are nearly constant for average beta energies greater than 0.1 MeV. Therefore, if a measurement of the skin contamination levels was recorded, it is possible to estimate an average dose coefficient for skin. That dose coefficient is about 9 rem h⁻¹ (beta plus gamma) per μCi/cm² of skin (Barss 2000). This includes a 30 to 35% overestimate due to the potential presence of an external backscatter surface (e.g., a contaminated surface or tool) and a gamma contribution of about 5%. For contaminated gloves, a dose reduction factor of 0.5 is assumed. However, without recorded skin contamination levels, the skin dose is virtually impossible to determine. Skin contamination estimates should be based on measurements when they are available. The VARSKIN code (Durham 1992) can be used for additional calculations of skin dose, presumably for source geometries where an assumption of uniform large-area contamination is inappropriate.

6.4.3 Neutron Radiation

6.4.3.1 Energy Dependence of Dosimetric Quantities

The neutron spectra at the NTS have been generally unmoderated and rich in fast neutrons, so much so that doses from thermal neutrons were most certainly trivial. However, in some operational situations, considerable scattering could have occurred, resulting in some softening of the spectra [37]. Attachment A, Section A.5 presents more detail on neutron spectral characteristics. Figure A-10 and Table A-4 indicate that the $H_p(10, 0^\circ)$ contribution from neutrons with energies less than 10 keV can be ignored for the purposes of NTS dose reconstruction. The primary $H_p(10)$ contributions fall in the energy ranges 100 keV to 2 MeV and 2 to 20 MeV. This information is summarized by energy band for a variety of spectra in Table 6-16 and NTS operational areas in Table 6-17.

Table 6-16. Fraction of $H_p(10,0^\circ)$ by energy band for selected spectra.

Spectral description	Neutron energy bands		
	<100 keV	100 keV–2 MeV	2 MeV–20 MeV
Cf-252	0.003	0.659	0.338
Cf-252 w/room scatter	0.017	0.691	0.292
Cf-252, 15 cm D ₂ O	0.089	0.579	0.332
Cf-252, D ₂ O w/room scatter	0.106	0.669	0.225
AmBe-241	0.001	0.261	0.738
AmBe w/ room scatter	0.010	0.366	0.624
PuBe at 1m	0.005	0.368	0.627
TRU Plant, Pu Repro. Plant, heavily shielded	0.080	0.734	0.186
Pu-238 O ₂ at 100 cm	0.021	0.821	0.158
Operation BREN HPRR ^a	0.15	0.62	0.23
Operation HENRE linear accelerator ^b	N/A	0.05	0.95
Super Kukla reactor ^c	0.10	0.86	0.04
Godiva spectrum	0.008	0.773	0.219

- a. These data are representative for the HPRR at an angle of incidence of zero. For other configurations, refer to Sims and Ragan 1987.
- b. These data are representative for the linear accelerator at an angle of incidence of zero. For other configurations, refer to Burson 1970.
- c. Source: Wimett 1965.

Table 6-17. Neutron field characteristics associated with NTS operational areas.^a

Area	Operation	Neutron sources	Neutron energy fractional distribution	
			Neutron energy–MeV	Fraction
4	Operation BREN, 1962	Fission neutrons (HPRR ^b)	<10 keV	0.10
			10–100keV	0.05
			0.1–2.0	0.62
			2.0–20	0.23
5	Low-level waste site (TRU waste) (1970-present)	TRU waste	0.1–2.0	1.00
6	Nuclear device assembly (1951-1992)	Fission neutrons	0.1–2.0	1.00
25	NRDS (1959-1973)	Fission neutrons & neutron sources Cf-252, PuBe, AmBe	0.1–2.0	1.00
	Operation HENRE (1966-1968)	Fission neutrons (linear accelerator ^c)	0.1 – 2.0 2.0 - 20	0.05 0.95
26	PLUTO Reactor (nuclear-powered ramjet engine) (1960-1964)	Fission neutrons & neutron sources Cf-252, PuBe, AmBe	0.1–2.0	1.00
27	Nuclear explosive assembly using special nuclear material (1958-1975)	Fission neutrons & neutron sources Cf-252, PuBe, AmBe	0.1–2.0	1.00
	Super Kukla (1964-1979)	Fission neutrons (Super Kukla reactor ^d)	10–100 keV 0.1–2.0 2–20	0.10 0.86 0.04
Various	Down-hole well logging (1951-present)	PuBe-238 isotopic sources	0.1–2.0	0.50
			2.0–20.	0.50
Various	Down-hole well logging (1951-present)	Cf-252 isotopic sources	0.1–2.0	0.75
			2.0–20.	0.25
Various	Neutron detection instrument calibration facilities (1955-present)	PuBe-238 isotopic sources	0.1–2.0	0.50
			2.0–20.	0.50

Area	Operation	Neutron sources	Neutron energy fractional distribution	
			Neutron energy—MeV	Fraction
Various	Neutron detection instrument calibration facilities (1955-present)	Cf-252 isotopic sources	0.1–2.0	0.75
			2.0–20.	0.25

- Neutron field characteristics are applicable to certain timeframes as indicated in Table 6-9.
- These data are representative for the HP RR at a angle of incidence of zero. For other configurations, refer to Sims and Ragan 1987.
- These data are representative for the linear accelerator at an angle of incidence of zero. For other configurations, refer to Burson 1970.
- Source: Wimett 1965.

The last column of Table 6-10 lists factors to make the conversion from *dose equivalent*, H (NCRP 1971) to *personal dose equivalent*, $H_p(10,0^\circ)$ for each of the four neutron energy groups for dose reconstruction at the NTS (none of the neutron-producing facilities generated a significant number of neutrons above 20 MeV). If the neutron spectra are not known, dose reconstructors should treat the exposure as having come from neutrons in the 0.1-to-2 MeV range, and should use a factor of 2 to convert from NCRP Report 38-based values to $H_p(10)$. If the spectral characteristics of the operational neutron field are known, dose reconstructors can use Table 6-19 to assign neutron dose fractions to the primary energy bands – 10 to 100 keV, 100 keV to 2 MeV and 2 to 20 MeV. In the absence of such information, however, it is recommended that dose reconstructors make the favorable to claimant assumption that neutron dose is entirely due to neutrons in the 100 keV to 2 MeV energy band.

6.4.3.2 Neutron-to-Photon Dose Ratios

The use of NTA film at NTS began in 1961 (REEC Co 1961). Prior to that time, an estimation of neutron doses to workers known to have worked with neutron emitting sources or in operations where neutrons were present (Table 6-17) could be made from the recorded photon dose, together with an appropriate neutron-to-photon dose ratio. The nominal neutron-to-photon dose ratios for isotopic neutron sources are listed in Table 6-18. These are based on literature values for the sources free in air. However, these values are not appropriate for estimation of the neutron dose from recorded photon dose because the photon usually includes a large fractional contribution from other photon sources that are not accompanied by neutrons. Therefore, if the neutron exposure is associated with the use of isotopic sources, use of a neutron-to-photon dose ratio of 5 is recommended. These operations include neutron instrument calibration and down-hole well logging.

Table 6-18. Neutron-to-photon dose ratios for isotopic sources.

Neutron sources	Neutron-photon dose equivalent rate ratio
Bare Cf-252	20.
Cf-252 moderated by 15 cm D ₂ O	5.6
PuBe-238	29. ^a
Am-241	>5. ^b

a. Mayer, Otto, and Golnik (2004).

b. ISO (2001).

Of the other neutron-related operations listed in Table 6-17, only the nuclear device assembly conducted in Area 6 and nuclear explosive assembly using special nuclear material were carried out prior to the introduction of personal dosimetry in 1961 (Allen and Schoengold 1995). Specific information on the neutron-to-photon dose equivalent ratios is not readily available for these operations at NTS. However, similar operations were carried out at the Pantex Plant. Based on analysis of dosimetry records at Pantex, as well as at the Hanford and Savannah River Sites, where

similar materials were handled, this resulted in a recommendation in the Pantex TBD on Occupational External Dose (ORAUT 2007a) that a neutron-to-photon dose equivalent ratio of 1.7 be adopted for Pantex workers. However, prior to 1960, nuclear weapons could have contained $^{210}\text{PoBe}$ or $^{238}\text{PuBe}$ initiators (DOE 1997). This would have increased the neutron-to-photon dose equivalent ratio.

Reactor operations in Areas 4, 25, 26, and 27 were conducted remotely, so workers were protected by a significant separation distance and by shielding in the case of the ramjet operations in Area 26 (Allen and Schoengold 1995; DOE 1995b). Moreover, the workers wore neutron dosimeters during reactor operation. When the reactor was shut down, the neutron production was drastically reduced to the point that the photon dose from fresh fission and activation products far exceeded any remaining neutron production. Because of this and the standard use of personal neutron dosimetry, the use of neutron-to-photon ratios is not recommended for these reactor operations.

6.4.3.3 Special Considerations

No single individual had access to areas in which there was potential for neutron exposure. Work in these areas always involved pairs of workers; two knowledgeable persons had to be involved with potential operational activities. This group probably involved only a few hundred workers and was limited to persons who worked on specific tasks in specific areas [26]. Neutron doses, for the most part, were low. In addition, neutron exposure was not possible without a concomitant gamma exposure. Although information on nominal neutron-to-gamma ratios appears later in this document, in practice these ratios can vary widely. Caution should be exercised before applying these ratios to gamma exposures for those who had worked in these operations (Table 6-9). Application to low-level photon exposures that were not associated with neutron source operations could lead to unrealistic estimates of neutron exposure [38].

If workers were unmonitored for fast neutrons, based on NTS personal dosimeter issue practices, and if there was no indication of exposure based on the thermal-neutron-sensitive component, it is highly unlikely that neutron exposure occurred [39]. If a worker's duties did not involve access to fissile materials or isotopic neutron sources, neutron exposures should not be considered in dose reconstruction. Therefore, dose reconstructors should not consider missed neutron dose for NTS personnel who were not monitored specifically for neutrons using NTA film or TLDs depending on the timeframe (see Table 6-1).

6.5 CLAIM ANALYSIS METHODS

Guidance in external radiation dose reconstruction is presented in ORAUT (2006c). NTS-specific recommendations are presented in the following sections. Basics of the dosimetry system through different types and operational periods are found in Table 6-1. There were no ongoing processes at NTS. The events that occurred in the various operations were discrete occurrences. The site description (ORAUT 2008a) includes a list of radionuclides of concern for various NTS activities and summarizes job descriptions for certain categories of workers that can help the dose reconstructor determine the most suitable method to use when evaluating the claim (i.e. minimizing, maximizing, or best estimate).

6.5.1 Photon Dose

Beginning in 1987, NTS occupational exposures were recorded in terms of *personal dose equivalent*, $H_P(d)$. For exposures during the period from 1951 to 1986, dose reconstructors should use the recorded photon dose values in terms of *exposure*, together with the Exposure to Organ Dose coefficients in Appendix B of NIOSH (2006b) to determine organ dose. Since 1987, the recorded values are in terms of $H_P(10)$, and the Deep-Dose-Equivalent-to-Organ-Dose conversion factors (NIOSH 2006b, Appendix B) should be used.

An exception to this guidance is at the NRDS facility during the period from 1970 to 1972 where a TLD was used and the Deep-Dose-Equivalent-to-Organ-Dose conversion factors (NIOSH 2006b, Appendix B) should be used.

Any recorded doses less than the LOD/2 for the era of the dosimetry should be included as missed dose instead of recorded dose (NIOSH 2006b).

Energy Range. For external dose reconstruction, if the conditions of exposure (work area, operation, etc.) are unknown, dose reconstructors should use the assumption favorable to claimants that photon energies are between 30 and 250 keV (NIOSH 2006b). If the exposure was due to fresh fallout (e.g., early reentry teams), it would be reasonable and still favorable to claimants to assume that 75% of the photon dose was from photons with energies above 250 keV (Kathren 2004; Coryell and Sugarman 1951; Nelms and Cooper 1959). If there is adequate documentation linking exposures to a particular NTS work area and/or operation, Table 6-9 presents guidance on a reasonable allocation of the recorded exposure or personal dose equivalent to the energy groups 30 to 250 keV and greater than 250 keV.

Prior to 1966, an additional 25% of the total dose should be included as an adjustment to account for the lead shielding described for some of the dosimeters (See Table 6-1). This is not considered an uncertainty and should be assigned to both the measured and the missed dose (Kathren 2004). The multi-element dosimeter was introduced in 1966 (DeMarre 2002).

Default values are 100% 30 to 250 keV for efficiently processing a claim or 25% 30 to 250 keV and 75% greater than 250 keV for a reasonable application. Table 6-13 provides more specific values that can be used if the location of the worker is clearly identified.

Bias. The bias should be applied to both the reported and the missed dose, when applying the bias increases the dose being assigned (NIOSH 2006b).

Uncertainty. To efficiently process a claim as non-compensable an uncertainty of 1.3 can be applied as maximizing to the measured dose (NIOSH 2006b). For a reasonable estimate, an uncertainty based on the GSD in Table 6-1 could be applied to the measured dose.

Missed Dose. Missed photon dose can be assigned based on the MDL/2 method and project guidance regarding reported dose under the MDL/2, and the number of exchange periods (NIOSH 2006b) given in Table 6-1 for the dosimetry systems or the dose of record provided by DOE. For many workers, the number of dosimeter exchanges will be greater than the routine monthly exchange. The dose reconstructor should evaluate the exchange cycles and assign the appropriate number of zero cycles or default values in Table 6-1 as applicable.

Special Situations

Noble Gas. The potential for noble gas exposure during post-test drilling was primarily limited to radiation technicians, drillers, and roughnecks. Such exposures were drastically reduced with the introduction of blow-out preventers in 1964 (LRL 1964, 1966). Reentry after tunnel events also had the potential for noble gas exposure to reentering miners and other crew members. Ventilation was usually introduced into tunnels following the events to reduce the potential for such exposure prior to reentry. However, if the ventilation was not working, or had not been provided at all, the potential for exposure existed. It should be noted that the number of individuals involved in such operations was small [35].

Unmonitored Workers. For potentially exposed unmonitored workers prior to 1958, an estimated dose favorable to the claimant can be assigned based on the 50% dose noted in the last column of Table 6-

11. This average annual dose can be adjusted during dose reconstruction to reflect the actual annual employment of the exposed person as verified by DOL. Many of the unmonitored workers were hired for a specific project and then terminated at the end of the project. Additionally, a missed dose of 20 mrem/month (LOD/2) can be assigned as favorable to the claimant. The review of ORAUT (2004) should help determine the applicability of assigning 30 mrem per month missed dose to the individual. For example, an administrative worker in Mercury has very limited potential for exposure. This should be reflected in any reported dose after April 1957 when universal badging was instituted. With all reported dose being zero and no job change, a case can be made that it is reasonable to assign the unmonitored dose and no missed dose at 20 mrem/month for an administrative worker in Mercury.

Nuclear Rocket Development Station. The dose models in the NRDL report (NRDL 1968) are applicable only to the relatively small population of NTS workers that were involved in re-entry operation following a nuclear propulsion rocket test at the Nuclear Rocket Development Station (NRDS). The data are experiment specific and require knowledge of specific physical parameters. It would be difficult to use these models for other NRDS experiments/re-entries since the empirical data necessary to develop the curves and tables for other events cannot be extracted from existing NTS records.

The NRDL report provides methods of computing doses from both individual particles and infinite field contamination levels from the nuclear rocket tests. The model provides methods for calculating doses to the lungs, GI tract, skin, and gonads for particular exposure scenarios. If a claimant who participated in NRDS nuclear rocket re-entries has a covered cancer in a location where a hot particle exposure has been documented, and the claimant can be associated with a specific test, and the requisite physical parameters for the test are available from NTS records, dose reconstructors may consider using the models and methods in the NRDL report. If this information is not available for NRDS workers, external exposures can be addressed through the procedures outlined in the Interpretation of Dosimetry Data for Assignment of Shallow Dose (ORAUT-OTIB-0017), the External Dose Reconstruction Implementation Guide (OCAS-IG-001, Rev. 2), and the VARSKIN model.

When factual information is provided, in dosimetry records or the telephone interview, that a claimant who participated in NRDS nuclear rocket re-entries has a covered cancer in a location where a hot particle exposure has been documented, and the claimant can be associated with a specific test, and the requisite physical parameters for the test are available from NTS records, dose reconstructors may consider using the models and methods in the NRDL report. Otherwise, NIOSH will not speculate on the potential exposure scenarios from large hot particles [36].

Hot Particles. The NTS sampling data, bioassay or environmental, does not indicate that hot particles were an issue at the NTS other than during the NRDS nuclear rocket test program. Historically the measurement of hot particles was not conducted at the NTS. Although insufficient or non-existent hot-particle data from the NTS makes dose calculations impractical, any **documented** hot-particle NTS external exposures can be addressed through the procedures outlined in the Interpretation of Dosimetry Data for Assignment of Shallow Dose (ORAUT-OTIB-0017), the External Dose Reconstruction Implementation Guide (OCAS-IG-001, Rev. 2), and the VARSKIN model.

6.5.2 Beta Dose

If an electron component needs to be assigned based on the cancer location or type, project guidance can be found in the current revision to ORAUT (2005), and site-specific guidance can be found in Attachments A and C. These sections provide the dose reconstructor with many options dependent on the circumstances of the Energy Employee (e.g., what ratio to apply depends on duties, location, and timeframe of employment). The following general guidelines can be applied:

- Before 1966, these ratios can also be applied to recorded photon dose and assigned as electron dose unless there is indication in the file that the employee was involved in reentry activities after an event. Attachments A and C provide areas and timeframes when a different ratio might be more appropriate. General guidelines are as follows for assignment on a dosimeter cycle by cycle basis:
 - At less than 3 days after an event, beta dose is 5 times the recorded photon dose.
 - At 4 to 42 days after an event, the beta dose is 10 times the recorded photon dose.
 - At more than 42 days after an event, the beta dose is 5 times the recorded photon dose.

These provisional dose ratios take no credit for shielding or attenuation of beta particles by clothing and assume a 1-m distance from the fission product field with no overburden, leaching, vegetation, or other material or weathering action that would reduce the ratio. For specific circumstances, other options from ORAUT (2006c) can be justified and applied by the dose reconstructor. The 50th percentile value of 1.04 is used with a geometric standard deviation of 2.41 for annual dosimeter results. The 95th percentile of 4.59 would be bounding for a noncompensable case. However considering project guidance (ORAUT 2005), using the 50% value is reasonable for all approaches (See Table 6-19).

Table 6-19. Summary of beta dose assignment.

Time frame	Technique
Pre 1966	Work area unidentified – 1.04 GM with GSD of 2.41
	Evidence of exposure during a drillback or tunnel re-entry – values appropriate to the time frame post event found in Table 6-15. These values to be applied to the dosimeter exchange for the drillback or tunnel reentry.
1966 and later	Measured beta dose adjusted consistent with project guidance (ORAUT 2005)

- Starting in 1966 with the recording of beta dose, for a minimizing approach in a compensable claim, the photon dose can also be assigned as the electron dose. This can be used when no particulars are available regarding worker location and timeframe of exposure (other than exposure prior to 1966).
- In a few cases prior to 1966, experimental dosimetry can be found in the files provided by DOE. These values should be doubled.
- After 1966, for a worker with reported beta or skin dose and no or limited information on duties and locations, the dose reconstructor should assign the reported electron dose.
- For a reasonable approach where the location of the employee at a specific point in time can be determined, the ratios in Attachment C for contaminated surfaces and immersion in a cloud are appropriate. Dependent on the type of contamination environment that is assigned to the worker, credit can be assigned for shielding, attenuation, length of exposure (stay time), and geometry can be considered, when determining the organ dose correction factor.

Because of the uncertainties associated with the application of beta-photon ratios to estimate potential beta exposures to NTS workers, dose reconstructors should only use these ratios when other relevant information, such as the optical density under the open area of a film badge, is not available.

For the beta produced by the decay of fission and activation products, the maximum energy typically does not exceed 3 MeV, and the range of a 3-MeV particle in air is approximately 36 ft. Fission products with very short half-lives can exceed the maximum energy of 3 MeV, but these can be ignored for all practical purposes. Therefore, an individual at a distance greater than 36 ft from a fallout field would not receive an external dose from beta radiation associated with the decay of

radionuclides produced by fission and fission-produced activation products. Similarly, an individual exposed to beta particles with energies below 70 keV would receive no beta dose to the skin because beta particles with energies below 70 keV have insufficient energy to penetrate the cornified outer layer of the skin [37].

Bias. The bias should be applied to both the reported and the missed dose, when applying the bias increases the dose being assigned. Bias from Table 6-1 should only be applied to electrons during those eras where an LOD for electrons is identified.

Uncertainty. To efficiently process a claim as non-compensable an uncertainty of 2 can be applied as maximizing to the measured beta or electron dose. For a reasonable estimate, an uncertainty based on the GSD in Table 6-1 could be applied to the measured dose. A minimizing approach is to include no uncertainty.

Special Situations

Unmonitored Workers. Prior to universal badging, only workers directly involved with the tests were provided with dosimetry (DeMarre 2002). From Table 6-11, photon dose is assigned to unmonitored workers based on the 50% dose to those who did receive monitoring. When the worker's photon dose is assigned in this manner, it is favorable to the claimant to assign an electron dose equal to the unmonitored photon dose. This likely contributes a greater electron component than the worker received given that the worker status was unmonitored. A minimizing approach is to assign no unmonitored electron dose. Given the range of electrons in air and the likelihood of an unmonitored worker being within that range, this is a reasonable approach [38].

Hot Particles. The NTS sampling data, bioassay or environmental, does not indicate that hot particles were an issue at the NTS other than during the NRDS nuclear rocket test program. Historically the measurement of hot particles was not conducted at the NTS. Any **documented** hot-particle NTS external exposures can be addressed through the procedures outlined in the Interpretation of Dosimetry Data for Assignment of Shallow Dose (ORAUT-OTIB-0017), the External Dose Reconstruction Implementation Guide (OCAS-IG-001, Rev. 2), and the VARSKIN model.

6.5.3 Neutron Dose

Dose reconstructors should convert recorded neutron dose to $H_P(10)$ using the bias values that appear in Table 6-1, and use the Deep-Dose-Equivalent-to-Organ-Dose conversion factors from Appendix B of NIOSH (2006b) to calculate the appropriate organ doses. In addition to the bias, the factors in Table 6-10 for conversion from NCRP Report 38 (NCRP 1971) and ICRP Publication 60 (ICRP 1991) neutron factors are to be applied. Table 6-17 provides neutron field characteristics associated with NTS operational areas and Table 6-9 provides the timeframe for application.

Energy. Assuming that 100% of the neutron doses were delivered by neutrons in the 0.1 to 2-MeV range is favorable to claimants. Table 6-19 includes neutron energy ranges that can be applied if more information is available on location and activities of the worker.

Missed Dose. Assign any missed dose based on the number of "OT" (other than thermal) neutrons found in the records provided by the DOE. If workers were unmonitored for fast neutrons, based on NTS personal dosimeter issue practices, and if there was no indication of exposure based on the thermal-neutron-sensitive component, it is highly unlikely that neutron exposure occurred [39]. If a worker's duties did not involve access to fissile materials or isotopic neutron sources, neutron exposures should not be considered in dose reconstruction.

There was a thermal neutron component in the NTS film badge packet from 1966 through 1986 to record neutron dose [44]. Every film badge packet issued on site had this component regardless of potential for exposure, therefore monitoring data is not necessarily an indicator of exposure to thermal neutrons during routine activities. Most of the neutron exposure at NTS in this time frame occurred in Area 25 (test reactor area). Low level exposure to neutrons in Area 12 would only intermittently have occurred and only involved workers who directly handled the fissile materials used for testing. During this activity, fast neutron monitoring was conducted using NTA film and thermal neutrons were monitored using the standard NTS film badge. Therefore, dose reconstructors should not consider missed neutron dose for NTS personnel who were not monitored specifically for neutrons using NTA film or TLDs depending on the timeframe (see Table 6-1). Starting in 1961 NTA film was assigned to those workers with the potential for exposure to neutrons (DeMarre 1993). Prior to that based on Table 6-9, it may be appropriate to assign neutrons based on a neutron-to-photon ratio applied to the reported photon dose.

Dose reconstructors should ignore neutron exposure unless there is evidence that the claimant was within 6 km of one or more of the atmospheric test detonation points at time of detonation.

Bias. The bias should be applied to both the reported and the missed dose, when applying the bias increases the dose being assigned. When using the neutron-to-photon ratio, the bias used should be from the appropriate neutron dosimeter era (Table 6-1) and the correction factor (conversion from NCRP to ICRP) applied based on the information in Table 6-10.

Uncertainty. To efficiently process a claim as non-compensable an uncertainty of 1.3 can be applied as maximizing to the measured dose. For a reasonable estimate, an uncertainty based on the GSD in Table 6-1 could be applied to the measured dose.

Neutron-Photon Ratio. The workplace neutron fields for specific types of nuclear weapons components are classified. Unclassified information on neutron spectra from nuclear weapons components is not available, but there are two sources, both with significant components above 2 MeV. Before about 1960, nuclear weapons could have contained $^{210}\text{PoBe}$ or $^{238}\text{PuBe}$ initiators (DOE 1997) with a higher neutron dose component relative to the measured photon dose. These initiators were not used after 1960. Prior to 1960, it is, therefore, recommended that a neutron-to-photon dose equivalent ratio of 1.7 be used for NTS workers who were involved in nuclear device assembly or nuclear explosive assembly using special nuclear material for neutron dose estimation during the periods when these operations were conducted based on the NTS records (ORAUT 2007a). Assembly occurred in Area 27, normally performed by the scientists and technicians from their respective laboratory facilities.

For exposures after 1960, if neutron dose information is not specifically available for those involved with final assembly and arming operations, photon exposure records, together with neutron-to-photon dose ratios can be used. The neutron-to-photon ratios can be derived from the experience at the Pantex Plant, where weapons assembly operations were conducted. Analysis of dose records for each Pantex worker with a positive neutron dose greater than 50 mrem for the period from 1993 to 2003 yields a geometric mean of 0.8 and GSD of 1.6. An upper 95th-percentile value of 1.7 should be used for the neutron-to-photon dose ratio (ORAUT 2007a).

Special Situations

Reactor Operations. Reactor and linear accelerator tests were conducted by various agencies at NTS (e.g., Operations BREN and HENRE and the Super Kukla reactor operations). For claimants with a record of participation in Operation BREN, specific information for the project is available in Auxier et al. 1962 and 1963, Cheka et al. 1965, Sanders et al. 1962, Sims and Ragan 1987, Thorngate and Loy 1965, and Thorngate et al. 1967. For claimants with a record of participation in Operation HENRE,

specific information for the project is available in Burson 1970, Butler and Haywood 1970, French and Mooney 1971, Haywood et al. 1965a and 1965b, Provenzano et al. 1965, Sanna et al. 1969, and Thorngate et al. 1969. For claimants with a record of participation at the Super Kukla reactor facility, specific information for the reactor is available in Wimett 1965. There were many individual and unique tests conducted at NTS and the TBD does not include a detailed account of all operations and activities. Additional information and references will be researched as appropriate as claims requiring this information are submitted.

6.6 ATTRIBUTIONS AND ANNOTATIONS

Where appropriate in this document, bracketed callouts have been inserted to indicate information, conclusions, and recommendations provided to assist in the process of worker dose reconstruction. These callouts are listed here in the Attributions and Annotations section, with information to identify the source and justification for each associated item. Conventional References, which are provided in the next section of this document, link data, quotations, and other information to documents available for review on the Project's Site Research Database.

- [1] DeMarre, Martha E. Nuclear Testing Archive. Manager. October 2003.
Ms. DeMarre, directly and through a large number of background documents, has provided a chronicle of the NTS radiation protection program for both external and internal exposure. Documents such as the Defense Nuclear Agency Reports (DNA-6000f through DNA-6040f) have provided details related to the radiation protection programs for each of the test series.
- [2] DeMarre, Martha E. and Griffith, Richard V. Nuclear Testing Archive, and ORAU Team. Manager and Principal Consultant. January 2004.
Beta doses are calibrated and measured in terms of absorbed dose. "Beta-particle fields shall be calibrated in terms of absorbed dose at a tissue depth of 7 mg/cm² ..." (DOE 1986a). The special unit of *absorbed dose* is the *rad*. *Dose equivalent, H*, is defined as the product of *absorbed dose* and *quality factor, Q*, or more recently, *radiation weighting factor, W_R*. The quality factor and radiation weighting factor for both *Q* and *W_R* have been set by the International Commission on Radiological Protection equal to 1. Therefore, the beta *dose equivalent* and *absorbed dose* are numerically equal. Therefore, the beta doses can also be reported in dose equivalent with the special unit of *rem*.
- [3] Griffith, Richard V. ORAU Team. Principal Consultant. April 2007.
After review of the dosimetry practices that had been used to determine the values to be entered in the dosimetry records, the bias factor represents the under- or overestimate of the measurement quantity by the recorded dose. By the convention adopted by the NTS dose reconstruction project, a bias factor less than 1.0 is used when the recorded value is believed to be an underestimate of the measurement quantity, while a bias factor greater than 1.0 is used when the recorded value is an overestimate of the measurement quantity. Simply put, bias factor = recorded value/measurement quantity.
- [4] Griffith, Richard V. ORAU Team. Principal Consultant. April 2007.
NIOSH (2006b) specifies that the value of the measurement quantity should then be multiplied by the dose conversion factors in Appendix B to obtain the organ dose.
- [5] DeMarre, Martha E. Nuclear Testing Archive. Manager. October 2003.
The dosimetry processing procedures, including the use of control films, has been outlined in REECo Environmental Sciences Standard Procedures for the years 1952 through 1985. These procedures have been compiled by Ms. DeMarre and are available. However, because of the number of procedures involved, they are not referenced individually.

- [6] DeMarre, Martha E. Nuclear Testing Archive. Manager. October 2003.
This is a matter of NTS record.
- [7] DeMarre, Martha E. and Griffith, Richard V. Nuclear Testing Archive, and ORAU Team. Manager and Principal Consultant. January 2004.
The temporary assignment of major laboratory and contractor employees at the NTS for periods of up to several weeks, perhaps punctuated by a return home over a weekend or for a few days, was a common practice and well known in the AEC/DOE contractor community.
- [8] DeMarre, Martha E. Manager, Nuclear Testing Archive. January 2004.
Ms. DeMarre has substantiated the practice of contractor employees exchanging NTS issued dosimeters for contractor badges on completion of their assignments.
- [9] Griffith, Richard V. ORAU Team. Principal Consultant. February 2007.
This is based on the experience of the data entry technicians during data entry. According to Cheryl Moore, Dade Moeller and Associates, NIOSH Project Data Entry Supervisor, often the LLNL or LANL records identify the NTS results as "NTS" or "visitor".
- [10] DeMarre, Martha E. Manager, Nuclear Testing Archive. February 2006.
TTR is the Tonopah Test Range. Sandia National Laboratory handled the dosimetry (if there was any) for the Tonopah Test Range. REECo had a Human Resources Office outside the NTS and one in town. There was a REECo medical clinic in Mercury and one in Las Vegas (Leased space until 1994).

When a REECo employee "processed in," the employee would usually start the process downtown. Downtown employees completed the process downtown. If the employee worked at NTS or Tonopah, they would usually report to the REECo Human Resources Office outside the gate. When they were ready to go to medical (which was inside at Mercury), they would have to get a dosimeter at Building 1000 (guard building - outside the gate). Once they had their badge, they would go to REECo medical (Mercury Building 650) and have their physical. They would physically be on the NTS for a very short period of time (hours).

They are actually listed as NTS visitors, where there is a place for a visitor indicator in the record. They do not have a permanent NTS security badge for TTR employment.

TTR employment was considered "Work for Others" (WFO) (in support of Sandia and the U.S. Air Force).

- [11] Griffith, Richard V. ORAU Team. Principal Consultant. February 2007.
A hot particle is essentially a point source of radiation. If that particle is not deposited directly on the dosimeter, the radiation field from the particle spreads so that the dosimeter cannot distinguish between the radiation field from the particle and that from a distributed source. Therefore, a hot particle that was deposited on the body at even a small distance from the dosimeter could not be identified.
- [12] Griffith, Richard V. ORAU Team. Principal Consultant. February 2007.
Hot particles will be removed in a short time (usually less than a day) after deposition on the body or clothing by washing or removal of the clothing. Once the particle has been removed, there is no way of knowing that it had been deposited unless associated radiation damage to the skin and underlying tissue manifested itself as an area of physical damage or a lesion.

- [13] Griffith, Richard V. ORAU Team. Principal Consultant. February 2007.
During interviews with people who were involved in NTS operations, including Jay Brady, there were a number of references to occasions when workers had intentionally left dosimeters in locations where they knew there would be little or no dose. One of the reasons commonly given was concern about reduction in pay that might be associated with work restrictions imposed if dose limits were exceeded. It should be noted that reports of this practice were not limited to NTS activities.
- [14] DeMarre, Martha E. and Griffith, Richard V. Nuclear Testing Archive, and ORAU Team. Manager and Principal Consultant. February, 2004.
The development of dosimetry technology, not only at the NTS but elsewhere in the AEC/DOE community, is documented in myriad reports by REECo, the national laboratories, the military, and other contractors. This development is reflected in several of the reports in the reference list, and is not necessary here.
- [15] Kathren, Ronald L. ORAU Team. Consultant. January 2004.
The potential large uncertainty (a factor of 2) is based on professional experience. The recommendation that “dose reconstructors should double the reported value to ensure favorability to claimants and to account for uncertainties” follows from this experience.
- [16] Griffith, Richard V. ORAU Team. Principal Consultant. February 2007.
The sensitive element of both film and TLD dosimeters used to detect incident beta particles is covered with a thin layer of protective material (paper, plastic, etc.). The range of a 0.015-MeV beta particle in unit density material is 4×10^{-3} mm, so the beta particles with energies ≤ 0.015 MeV would be absorbed in the inert protective material and not be detected.
- [17] DeMarre, Martha E. and Griffith, Richard V. Nuclear Testing Archive, and ORAU Team. Manager and Principal Consultant. February 2004.
Mechanisms for production of neutrons are limited and well defined:
- Nuclear fission
 - Alpha,neutron reactions with a small number of light nuclides (lithium, boron, beryllium, etc.)
 - Accelerator production
- The facilities or operations at the NTS that are capable of producing neutrons have been identified in Section 2 (ORAUT 2008a) and are summarized briefly in this section. Because of the nature of these operations, and the associated hazards, access of individuals has been carefully controlled.
- NTA film, albedo TLDs, and track etch dosimeters were not issued to all personnel at the NTS. They were issued only to individuals that might have a potential for exposure to neutrons.
- The brief reactor runs had a very small potential for neutron exposure. The higher potential was from sources (such as Pu-Be & ²⁵²Cf) to an extremely small number of people. The tasks included instrument calibration and well logging. The number of workers with a potential for exposure would be extremely low.
- [18] Griffith, Richard V. ORAU Team. Principal Consultant. February 2004.
The use of *field calibrations* is and has been standard practice in radiation protection for many years. It allows direct comparison of the response of dosimeters and reference or survey instruments in the occupational environment and eliminates, among other things, uncertainties

about the effects of energy response because the operational field becomes the calibration field as well.

- [19] Griffith, Richard V. ORAU Team. Principal Consultant. February 2004. Neutron calibration can be performed with isotopic sources, reactor beams, or accelerators. However, use of facilities such as reactors and accelerators for calibration of dosimeters and survey instruments involves a significant commitment of resources and labor. They are normally only used for special calibration requirements such as establishing the energy response of instruments and dosimeter designs. Once that has been done, simpler, less labor-intensive methods are used to confirm proper operation of neutron detection equipment. Isotopic sources such as ^{252}Cf , $^{238}\text{Pu-Be}$, etc. are much more readily available to the normal radiation protection organization, and are used much more widely.
- [20] DeMarre, Martha E. and Griffith, Richard V. Nuclear Testing Archive, and ORAU Team. Manager and Principal Consultant. March 2004. Operational field calibrations for neutrons require levels of a few tenths of a millirem so the measurements can be conducted in a reasonable time. From discussions with NTS radiation protection specialists such as Jay Brady and Joe Wells, or in going through the NTS records, there is no indication that such field calibrations were ever attempted.
- [21] Griffith, Richard V. ORAU Team. Principal Consultant. March 2007. Because of variations in track etch detector materials, etc., the practical detection level for fast neutrons (from ^{252}Cf , $^{238}\text{Pu-Be}$, etc.) is higher than that achieved under highly controlled conditions – typically about 25 mrem. However, for moderated spectra, a significant fraction of the neutrons will have energies below the energy detection threshold for the TEDs. In addition, because the factor to be applied to NTS neutron dose in the 0.1- to 2-MeV region is 2 as a result of the difference between NCRP and ICRP dose conversion factors (Table 6-10), the recommended MDL is 50 mrem.
- [22] DeMarre, Martha E. and Griffith, Richard V. Nuclear Testing Archive, and ORAU Team. Manager and Principal Consultant. March 2004. Because of the scale and design of operations, and the time to reentry, exposure to radioiodines and noble gases during tunnel reentries was limited to those actually involved in the reentry – miners and radiation technicians.
- [23] Griffith, Richard V. ORAU Team. Principal Consultant. March 2007. Fission products are formed directly so that there are at least two fission product atoms formed from each fission. Activation products are formed as a secondary process through interaction of the fission product neutrons with adjacent materials (soil, structures, etc.). Activation product formation is geometry dependent so that fewer activation product atoms are formed from an air burst than a surface burst. Moreover, the activation products are distributed with depth in soil because they originate primarily by interactions with neutrons that penetrate into the soil rather than in deposition from the atmosphere. Thus, beta doses from activation products are reduced because most of the activation products are deeper in the soil than the range of the emitted beta particles.
- [24] Griffith, Richard V. ORAU Team. Principal Consultant. March 2007. Attachment D illustrates, using two different methods, that personnel doses at distances greater than 6 km would be less than 1 mrem.
- [25] DeMarre, Martha E. Nuclear Testing Archive. Manager. April 2006. The device was assembled by the specialists from the laboratories (LANL, LLNL, etc.).

- [26] DeMarre, Martha E. and Griffith, Richard V. Nuclear Testing Archive, and ORAU Team. Manager and Principal Consultant. February 2004. Neutron sources were used for very specific jobs such as instrument calibration and well logging. These jobs required specialized training, including the potential hazards associated with use of the sources, and involved only a few individuals such as radiation technicians. When they were in use, individuals who were not directly involved in the task were kept away from the sources and at a safe distance.
- [27] DeMarre, Martha E. Nuclear Testing Archive. Manager. October 2003. Ms. DeMarre has provided information about personnel dosimeter issuance.
- [28] Griffith, Richard V. ORAU Team. Principal Consultant. March 2007. The error introduced in using a 1-to-1 rad-to-roentgen relationship and ignoring the conversion of 100 rad = 114 R is 14 %. However, the uncertainties caused by the significant beta geometry and energy dependence of the beta-photon ratios are much larger and can exceed a factor of 2 or more. Therefore, 14% becomes acceptable in the context of other much larger errors.
- [29] Griffith, Richard V. ORAU Team. Principal Consultant. March 2007. Immersion in a cloud was generally associated with radioactive gases, which are normally dispersed quite rapidly in an open environment. Under normal conditions, this would not be common. Most exposures would have resulted from surfaces (ground, etc.) that were contaminated by postshot fallout. The exception would be exposure following a release of gases during postshot drilling.
- [30] Griffith, Richard V. ORAU Team. Principal Consultant. March 2007. Using data from Keith Eckerman and the EPA Federal Guidance Report-13 code (Eckerman et al. 1999) it is possible to calculate beta-photon ratios for the fallout inventories generated by Hicks (1981a to 1981i). These ratios can then be applied, with care, to the photon doses obtained from the personal dosimetry records.
- [31] Griffith, Richard V. ORAU Team. Principal Consultant. March 2007. Beta-photon ratios are highly dependent on geometry, including any intervening material (air, etc.), beta and photon energies, and other factors. Although calculations can be made for well-defined situations, application of the results can result in significant errors if the actual exposure conditions deviate significantly from the assumptions that were used for the calculations.
- [32] Griffith, Richard V. ORAU Team. Principal Consultant. March 2007. The energy spectrum of fast neutrons can easily be degraded by intervening materials and loss of energy through scattering from materials in the vicinity of the source. This occurs, for example, when there is a significant amount of concrete, soil, etc. near the source of neutrons.
- [33] Griffith, Richard V. ORAU Team. Principal Consultant. March 2007. Application of neutron to gamma ratios to the recorded photon dose from the individual monitoring records assumes that the total photon dose was received from a given mixed photon-neutron source environment. However, if a significant portion of the photon dose for the monitoring period was received in an environment that did not have associated neutrons (e.g., a neutron-free field with only photon and beta contamination), the estimated neutron dose would be higher than actually received.

- [34] DeMarre, Martha E. and Griffith, Richard V. Nuclear Testing Archive, and ORAU Team. Manager and Principal Consultant. March 2004.
Personnel were issued fast neutron dosimeters if they were known to have been working with or had access to neutron sources. Moreover, all personnel dosimeters after 1961 had some thermal neutron sensitive component. If (1) an individual was not issued a fast neutron dosimeter and (2) there was no indication of a thermal neutron exposure on the thermal neutron sensitive component, it was highly unlikely that there had been a neutron exposure. Such exposure would have been reflected by an indication on the thermal dosimeter component.
- [35] DeMarre, Martha E. and Griffith, Richard V. Nuclear Testing Archive, and ORAU Team. Manager and Principal Consultant. March 2004.
The personnel with potential for noble gas exposure during a postshot drilling operation were those whose job assignments called for them to be directly involved in the drilling operation – drilling crew members and radiological technicians. Because of the training and skills that were required for these jobs, the number of people who were involved was small.
- [36] Rollins, Eugene M. ORAU Team. Division Manager. August 2007.
ORAU Team resolution of comments provided by Sanford Cohen & Associates.
- [37] Griffith, Richard V. ORAU Team. Principal Consultant. March 2007.
The range of a 70-keV beta particle is about 7 mg/cm² in tissue, and it cannot penetrate the dead or cornified outer layer of the skin. Therefore, there is no beta dose to the sensitive layer from beta particles with energies below 70 keV.
- [38] Griffith, Richard V. ORAU Team. Principal Consultant. March 2007.
Unmonitored workers are highly unlikely to have been in areas where significant beta fields would have existed. More over, in view of the short range of beta particles in air (generally less than 100 cm), (1) workers would have had to be quite close to these sources and (2) the sources would have been much more intense than contamination background fields. Therefore, it is quite reasonable to assign no unmonitored electron dose for unmonitored workers.
- [39] Arana, Joel. ORAU Team. Senior Health Physicist. March 2007.
Explanation of the thermal neutron component in the NTS film badge as recommended by Tim Taulbee of NIOSH. Also noted that the thermal neutron component isn't used for accident monitoring.
- [40] Griffith, Richard V. ORAU Team. Principal Consultant. April 2007.
Allen and Schoengold (1995) states, "The Panasonic UD-802 TLDs have well-known and documented energy responses." As a large commercial supplier of dosimeters, this is true of all of the Panasonic TLDs, including the UD-809, which is not specifically addressed in the REECo document.
- [41] Griffith, Richard V. ORAU Team. Principal Consultant. April 2007.
This information is provided in detail in the *Characteristics of the Panasonic UD-8xx series Thermoluminescent Dosimeters* fact sheet from the Panasonic Web site at http://www.panasonic.com/industrial/other/pdf/dosimeter_types.pdf.
- [42] Griffith, Richard V. ORAU Team. Principal Consultant. April 2007.
The neutron response of NTA film at 4 MeV is approximately 2.1 times that at 1 MeV (IAEA 1990). This means that 4-MeV neutrons, when corrected for a personal dose equivalent difference of less than 10%, will create twice as many tracks as 1 MeV neutrons per unit

$H_p(10)$. As a result, if a dosimeter has been calibrated with an alpha,neutron source such as plutonium or Am-Be and that dosimeter is used in a fission neutron environment, the number of track density is interpreted as a dose that is half the actual fission neutron dose. This underestimate is even worse if the field has a significant number of neutrons below the 0.5-MeV NTA threshold.

REFERENCES

- AEC (U.S. Atomic Energy Commission), 1961, *Radiological Safety*, Chapter 0524, NTSO-0524-1, Las Vegas, Nevada, June 26. [SRDB Ref ID: 12468]
- Allen, T. E., and C. R. Schoengold, 1995, *External Dosimetry Technical Basis Manual for the Nevada Test Site and Other Designated Locations*, (548)-6.4.1, Reynolds Electrical and Engineering Company, Las Vegas, Nevada, December. [SRDB Ref ID: 14099]
- Auxier, J. A., F. W. Sanders, F. F. Haywood, J. H. Thorngate, and J. S. Cheka, 1962, *Technical Concept - Operation BREN*, CEX-62.01, U.S. Civil Effects Test Operations, AEC, Oak Ridge, Tennessee, December. [SRDB Ref ID: 37779]
- Auxier, J. A, F. F. Haywood, and L. W. Gilley, 1963, *General Correlative Studies – Operation BREN*, CEX-62.03, U.S. Civil Effects Test Operations, AEC, Oak Ridge, Tennessee, September. [SRDB Ref ID: 37782]
- Barss, N. M., 2000, *Methods and Applications for Dose Assessment of Beta Particle Radiation*, SAIC-001/2024, Science Applications International Corporation, January. [SRDB Ref ID: 26379]
- Barss, N. M., and R. L. Weitz, 2006, "Reconstruction of External Dose From Beta Radiation Sources of Nuclear Weapon Origin," *Health Physics*, volume 91, number 4, pp. 379–389. [SRDB Ref ID: 26776]
- Bechtel Nevada, 2001, Dosimetry Issue/Return, Organization Instruction, OI-0441.024, 30 October, 2001. [SRDB Ref ID: 2062]
- Beck, H. L., 1980, *Exposure Rate Conversion Factors for Radionuclides Deposited on the Ground*, EML-387, U.S. Department of Energy, Environmental Measurements Laboratory, New York, New York, July. [SRDB Ref ID: 35519]
- Becker, K., 1966, *Photographic Film Dosimetry*, The Focal Press, London, England.
- Black, R. H., 1962, "Some Factors Influencing the β -Dosage to Troops," *Health Physics*, volume 8, pp. 131–141.
- Boone, F. W., E. D. Bennett, and S. B. Adams, 1970, *Progress Report, NRDS Personnel Dosimetry Program, Statistical Comparison of TLD and Film Dosimeter Data*, 33-37, Pan American World Airways, Nuclear Rocket Development Station Project, Jackass Flats, Nevada, July 24. [SRDB Ref ID: 13988]
- Brady, W. J., and G. K. Iverson, 1968, *Combination Personnel Dosimeter and Security Credential Holder*, NVO-162-27 (revised) , Reynolds Electrical and Engineering Company, Nevada Test Site, Mercury, Nevada, September. [SRDB Ref ID: 1477]
- Brady, W. J., and A. G. Nelson, 1985, *Radiac Instruments and Film Badges Used at Atmospheric Nuclear Tests*, DNA-TR-84-338, Jaycor, Alexandria, Virginia, September 26. [SRDB Ref ID: 1510]
- Broido, A., and J. D. Teresi, 1961, "Analysis of the Hazards Associated with Radioactive Fallout Material – I. Estimation of γ - and β -Doses," *Health Physics*, volume 5, pp. 63–69.

- Burson, Z.G., 1970, *Radiation Output Description from the $T(d,n)^4\text{He}$ Reaction in a Large Target (1000 cm²): Operation HENRE*, CEX-65.04, U.S. Civil Effects Test Operations, AEC, Oak Ridge, Tennessee, January. [SRDB Ref ID: 39858]
- Butler, H.M. and F. F. Haywood, 1970, *Radiation Safety Practices: Operation HENRE*, CEX-65.05, U.S. Civil Effects Test Operations, AEC, Oak Ridge, Tennessee, January. [SRDB Ref ID: 39861]
- Cardis, E., M. Vrijheid, M. Blettner, E. Gilbert, M. Hakama, C. Hill, G. Howe, J. Kaldor, C. R. Muirhead, M. Schubauer-Berigan, T. Yoshimura, F. Bermann, G. Cowper, J. Fix, C. Hacker, B. Heinmiller, M. Marshall, I. Thierry-Chef, D. Utterback, Y-O. Ahn, E. Amoros, P. Ashmore, A. Auvinen, J-M. Bae, J. B. Solano, A. Biau, E. Combalot, P. Deboodt, A. Diez Sacristan, M. Eklof, H. Engels, G. Engholm, G. Gulis, R. Habib, K. Holan, H. Hyvonen, A. Kerekes, J. Kurtinaitis, H. Malke, M. Martuzzi, A. Mastauskas, A. Monnet, M. Moser, M. S. Pearce, D. B. Richardson, F. Rodriguez-Artalejo, A. Rogel, H. Tardy, M. Telle-Lamberton, I. Turai, M. Usel, and K. Veress, 2005, "Risk of Cancer After Low Doses of Ionising Radiation: Retrospective Cohort Study in 15 Countries," *British Medical Journal*, volume 331, p. 77.
- Cheka, J. S., 1954, "Recent Developments in Film Monitoring of Fast Neutrons," *Nucleonics*, Volume 12, number 6, pp. 40–43. [SRDB Ref ID: 25005]
- Cheka, J. S., F. W. Sanders, T. D. Jones, and W. H. Shinpaugh, 1965, *Distribution of Weapons Radiation in Japanese Residential Structures*, CEX-62.11, U.S. Civil Effects Test Operations, AEC, Oak Ridge, Tennessee, March. [SRDB Ref ID: 37784]
- Collison, T. D., 1953, *Radiological Safety Operation*, WT-702(REF), Field Command, Armed Forces Special Weapons Project, Albuquerque, New Mexico, June. [SRDB Ref ID: 2480]
- Collison, T. D., 1955, *Radiological Safety*, Field Command, Armed Forces Special Weapons Project, Albuquerque, New Mexico, May. [SRDB Ref ID: 2498]
- Coryell, C. D., and N. Sugarman, editors, 1951, *The Fission Products*, National Nuclear Energy Series, Book I, Division IV, Part IV, McGraw-Hill, New York, New York.
- Cross, W. G., H. Ing, N. O. Freedman, and J. Mainville, 1982, *Tables of Beta-ray Dose Distributions in Water, Air and Other Media*, AECL-7617, Atomic Energy of Canada, Chalk River, Ontario. [SRDB Ref ID: 40277]
- DeMarre, M., 1993, *1951-1973-NTS Instrument Summary*, Private Communication, U.S. Department of Energy, Nevada Operations Office, Las Vegas, Nevada. [SRDB Ref ID: 2080]
- DeMarre, M., 2002, "Monitoring of Personnel Exposures in Association with the Nuclear Testing Program," Nevada Test Site External Dosimetry Fact Sheet. [SRDB Ref ID: 1904]
- DeMarre, M., 2003, "RE: Information Request," e-mail to L. Arent (Oak Ridge Associated Universities Team), U.S. Department of Energy, Nevada Operations Office, Las Vegas, Nevada, September 17. [SRDB Ref ID: 14053]
- DeMarre, M., 2006a, "Use of PIC Dosimeter Results at the NTS," private communication with R. Griffith (Oak Ridge Associated Universities Team), U.S. Department of Energy, Nevada Operations Office, Las Vegas, Nevada. [SRDB Ref ID: 40282]

- DeMarre, M., 2006b, "NTPR Data Definitions," private communication with R. Griffith (Oak Ridge Associated Universities Team), U.S. Department of Energy, Nevada Operations Office, Las Vegas, Nevada. [SRDB Ref ID: 40283]
- DeMarre, M., 2006c, "Extremity Monitoring for NTS Workers," private communication with R. Griffith (Oak Ridge Associated Universities Team), U.S. Department of Energy, Nevada Operations Office, Las Vegas, Nevada. [SRDB Ref ID: 40284]
- DeMarre, M., 2006d, "Exposure Matrix for NTS and PPG Associated Persons Based on Query of Historical Dosimetry (1945-1983) Database," e-mail to J. Fix (Oak Ridge Associated Universities Team), U.S. Department of Energy, Nevada Operations Office, August 3. [SRDB Ref ID: 27080]
- DeMarre, M., 2007a, "RE: Summary Dosimetry Statistics," e-mail to C. Smith, August 20, Oak Ridge Associated Universities, Oak Ridge, Tennessee. [SRDB Ref ID: 34464]
- Demarre, M., 2007b, "Neutron Calibration Sources at NTS," e-mail to D. Griffith, November 6, Oak Ridge Associated Universities, Oak Ridge Tennessee. [SRDB Ref ID: 42676]
- DNA (Defense Nuclear Agency), 1985, *Neutron Exposure for DoD Nuclear Test Personnel*, DNA-TR-84-405, Science Applications International Corporation, McLean, Virginia, August 15. [SRDB Ref ID: 40286]
- DOE (U. S. Department of Energy), 1986a, *Department of Energy Standard for the Performance Testing of Personnel Dosimetry Systems, DOE Laboratory Accreditation Program for Personnel Dosimetry Systems*, DOE/EH-0027, Assistant Secretary for Environment, Safety, and Health, Washington, D.C., December. [SRDB Ref ID: 12294]
- DOE (U.S. Department of Energy), 1982, *Radiological Safety*, Chapter 0524, NTS-SOP-0524, Nevada Operations Office, Las Vegas, Nevada, July 23. [SRDB Ref ID: 13991]
- DOE (U.S. Department of Energy), 1986b, *Handbook for the Department of Energy Laboratory Accreditation Program for Personnel Dosimetry Systems*, DOE/EH-0026, Assistant Secretary for Environment, Safety, and Health, Washington, D.C., December. [SRDB Ref ID: 12293]
- DOE (U.S. Department of Energy), 1988, *Radiation Protection for Occupational Workers*, Order 5480.11, Office of Environment, Safety and Health, Washington D.C., December 21. [SRDB Ref ID: 8073]
- DOE (U.S. Department of Energy), 1994, *U.S. Department of Energy Radiological Control Manual*, DOE/EH-0256T, Rev. 01, Office of Assistant Secretary for Environment, Safety and Health, Washington, D.C., April. [SRDB Ref ID: 14856]
- DOE (U.S. Department of Energy), 1995a, *Department of Energy Laboratory Accreditation Program for Personnel Dosimetry Systems*, DOE-STD-1095-95, U.S. Department of Energy, Washington, D.C., December, 1995. [SRDB Ref ID: 40288]
- DOE (U.S. Department of Energy), 1995b, *Radiological Effluents Released from Nuclear Rocket and Ramjet Engine Tests at the Nevada Test Site: Fact Book*, DOE/NV 401, June. [SRDB Ref ID: 2594]

- DOE (U.S. Department of Energy), 1997, *Linking Legacies: Connecting the Cold War Nuclear Weapons Production Processes to Their Environmental Consequences*, DOE/EM-0319, Office of Environmental Management, Washington, D.C., January. [SRDB Ref ID: 11930]
- DOE (U.S. Department of Energy), 2000, *United States Nuclear Tests, July 1945 through September 1992*, DOE/NV--209-Rev. 15, Nevada Operations Office, Las Vegas, Nevada, December. [SRDB Ref ID: 2433]
- DOE (U.S. Department of Energy), 2002, *Nuclear Rocket Development Station tested nuclear rocket for Mars mission*, DOE/NV Information Sheet, Nevada Operations Office, Las Vegas, Nevada. [SRDB Ref ID: 40274]
- DOE (U.S. Department of Energy), 2007, *Closure Report for Corrective Action Unit 118: Area 27 Super Kukla Facility Nevada Test Site, Nevada*, DOE/NV-1223, September. [SRDB Ref ID: 42679]
- Dudley, R. A., 1966, "Dosimetry with Photographic Emulsions," *Radiation Dosimetry, Volume 2*, F. H. Attix and W. C. Roesch, editors, Academic Press, New York, New York.
- Durham, J. S., 1992, *VARSKIN Mod 2 and SADDE Mod 2: Computer Codes for Assessing Skin Dose from Skin Contamination*, NUREG/CR-5873, U.S. Nuclear Regulatory Commission, Washington, D.C. [SRDB Ref ID: 22725]
- Eckerman, K. F., 2006a private communication with R. Griffith (Oak Ridge Associated Universities), Oak Ridge National Laboratory, Oak Ridge, Tennessee. [SRDB Ref ID: 40280]
- Eckerman, K. F., 2006b, private communication with R. Griffith (Oak Ridge Associated Universities), Oak Ridge National Laboratory, Oak Ridge, Tennessee. [SRDB Ref ID: 40281]
- Eckerman, K. F., R. W. Leggett, C. B. Nelson, J. S. Puskin, and A. C. B. Richardson, 1999, *Cancer Risk Coefficients for Environmental Exposure to Radionuclides, Radionuclide-Specific Lifetime Radiogenic Cancer Risk Coefficients for the U.S. Population, Based on Age-Dependent Intake, Dosimetry, and Risk Models*, Federal Guidance Report No. 13, EPA 402-R-99-001, U.S. Environmental Protection Agency, Office of Radiation and Indoor Air, Washington, D.C., September. [SRDB Ref ID: 13719]
- Ehrlich, M., 1954, *Photographic Dosimetry of X and Gamma Rays*, Handbook 57, U.S. Department of Commerce, National Bureau of Standards, Washington, D.C., August 20. [SRDB Ref ID: 11309]
- Ehrlich, M., 1962, *The Use of Film Badges for Personnel Monitoring*, Safety Series No. 8, STI-PUB-43, International Atomic Energy Agency, Vienna, Austria, June 28.
- Firestone, R. B., and L. P. Ekström, 2004, *LBNL Isotopes Project - LUNDS Universitet, WWW Table of Radioactive Isotopes*, Lawrence Berkeley National Laboratory and Lund University, Sweden <http://ie.lbl.gov/toi/>. [SRDB Ref ID: 42379]
- Fix, J. J., E. S. Gilbert, and W. V. Baumgartner, 1994, *An Assessment of Bias and Uncertainty in Recorded Dose from External Sources of Radiation for Workers at the Hanford Site*, PNL-10066, Battelle Memorial Institute, Pacific Northwest Laboratory, Richland, Washington, August. [SRDB Ref ID: 305]

- Fix, J. J., L. Salmon, G. Cowper, and E. Cardis, 1997, "A Retrospective Evaluation of the Dosimetry Employed in an International Combined Epidemiologic Study," *Radiation Protection Dosimetry*, volume 74, pp. 39–53. [SRDB Ref ID: 7769]
- Fix, J. J., R. H. Wilson, and W. V. Baumgartner, 1997, *Retrospective Assessment of Personnel Neutron Dosimetry for Workers at the Hanford Site*, PNNL-11196, Battelle Memorial Institute, Pacific Northwest National Laboratory, Richland, Washington, February. [SRDB Ref ID: 5275]
- French, R. L. and L. G. Mooney, 1971, *Differential Measurements of Fast-Neutron Air-Ground Interface Effects (Project 9.2 of Operation HENRE)*, CEX-65.92, U.S. Civil Effects Test Operations, AEC, Oak Ridge, Tennessee, January. [SRDB Ref ID: 39867]
- Glasstone, S., and P. J. Dolan, editors, 1977, *The Effects of Nuclear Weapons, Third Edition*, U.S. Department of Defense and U.S. Department of Energy, Washington, D.C.
- Griffith, R. V., 2004, *Resolution of Question Regarding Quantities Used for Reporting the Measurement of Personnel Exposures to Photons at the NTS, 1962 to 1987*, Woodbridge, California, August 4. [SRDB Ref ID: 13989]
- Griffith, R. V., 2005, *Development of Work Area and Operation-Dependent Energy Group Photon Fractions*, Oak Ridge Associated Universities, Oak Ridge, Tennessee. [SRDB Ref ID: 41175]
- Griffith, R. V., 2007, "Correction Factors for External Environmental Dose," Private Communication, Oak Ridge Associated Universities, Oak Ridge, Tennessee. [SRDB Ref ID: 29310]
- Griffith, R.V. and Tommasino, L. 1990, "Etch Track Detectors in Radiation Dosimetry," *The Dosimetry of Ionizing Radiation*, Volume III, Academic Press, pp. 323–426.
- Hadlock, D. E., L. W. Brackenbush, R. V. Griffith, D. E. Hankins, and M. A. Parkhurst, 1988, *Personnel Neutron Dose Assessment Upgrade, Volume I, Personnel Neutron Dosimetry Assessment*, PNL-6620 Vol. 1, Battelle Memorial Institute, Pacific Northwest Laboratory, Richland, Washington, July. [SRDB Ref ID: 14858]
- Hankins, D. E., 1977, "Energy Dependence of Remmeters and Albedo Neutron Dosimeters at Energies of Thermal and between 2 keV and 5.67 MeV," *Proceedings of the Fourth International Congress of the International Radiation Protection Association*, volume 2, pp. 553–556. [SRDB Ref ID: 13994]
- Hankins, D. E., S. G. Homann, and J. Westermarck, 1987, *Personnel Neutron Dosimetry Using Electrochemically Etched CR-39 Foils*, UCRL-53833, University of California, Lawrence Livermore National Laboratory, Livermore, California. [SRDB Ref ID: 13995]
- Haywood, F. F., T. G. Provenzano, and J. A. Auxier, 1965a, *Operations Plan - Operation HENRE*, CEX-65.03, U.S. Civil Effects Test Operations, AEC, Oak Ridge, Tennessee, June. [SRDB Ref ID: 41177]
- Haywood, F. F. and J. A. Auxier, 1965b, *Technical Concept - Operation HENRE*, CEX-65.02, U.S. Civil Effects Test Operations, AEC, Oak Ridge, Tennessee, February. [SRDB Ref ID: 40287]
- Hicks, H. G., 1981a, *Calculation Concentrations of any Radionuclide Deposited on the Ground by Release from Underground Nuclear Detonations, Tests of Nuclear Rockets, and Tests of*

Nuclear Ramjet Engines, UCRL-53228, University of California, Lawrence Livermore National Laboratory, Livermore, California, November. [SRDB Ref ID: 1828]

- Hicks, H. G., 1981b, *Results of Calculations of External Gamma Radiation Exposure Rates from Fallout and the Related Radionuclide Compositions, Operation Ranger, 1951*, UCRL-53152-Pt.1, University of California, Lawrence Livermore National Laboratory, Livermore, California, July. [SRDB Ref ID: 1854]
- Hicks, H. G., 1981c, *Results of Calculations of External Gamma Radiation Exposure Rates from Fallout and the Related Radionuclide Compositions, Operation Buster Jangle, 1951*, UCRL-53152-Pt.2, University of California, Lawrence Livermore National Laboratory, Livermore, California. [SRDB Ref ID: 1831]
- Hicks, H. G., 1981d, *Results of Calculations of External Gamma Radiation Exposure Rates from Fallout and the Related Radionuclide Compositions, Operation Tumbler-Snapper, 1952*, UCRL-53152-Pt.3, University of California, Lawrence Livermore National Laboratory, Livermore, California, July. [SRDB Ref ID: 1832]
- Hicks, H. G., 1981e, *Results of Calculations of External Gamma Radiation Exposure Rates from Fallout and the Related Radionuclide Compositions, Operation Upshot-Knothole, 1953*, UCRL-53152-Pt.4, University of California, Lawrence Livermore National Laboratory, Livermore, California, July. [SRDB Ref ID: 1835]
- Hicks, H. G., 1981f, *Results of Calculations of External Gamma Radiation Exposure Rates from Fallout and the Related Radionuclide Compositions, Operation Teapot, 1955*, UCRL-53152-Pt.5, University of California, Lawrence Livermore National Laboratory, Livermore, California, July. [SRDB Ref ID: 1838]
- Hicks, H. G., 1981g, *Results of Calculations of External Gamma Radiation Exposure Rates from Fallout and the Related Radionuclide Compositions, Operation Plumbob, 1957*, UCRL-53152-Pt.6, University of California, Lawrence Livermore National Laboratory, Livermore, California, July. [SRDB Ref ID: 1839]
- Hicks, H. G., 1981h, *Results of Calculations of External Gamma Radiation Exposure Rates from Fallout and the Related Radionuclide Compositions, Operation Hardtack II, 1953*, UCRL-53152-Pt.7, University of California, Lawrence Livermore National Laboratory, Livermore, California, July. [SRDB Ref ID: 1846]
- Hicks, H. G., 1981i, *Results of Calculations of External Gamma Radiation Exposure Rates from Fallout and the Related Radionuclide Compositions, Operation Nougat through Bowline, 1962–1968*, UCRL-53152-Pt.8, University of California, Lawrence Livermore National Laboratory, Livermore, California, July. [SRDB Ref ID: 1851]
- Hicks, H. G., 1982, "Calculation of the Concentration of any Radionuclide Deposited on the Ground by Offsite Fallout from a Nuclear Detonation", *Health Physics*, volume 42, number 5, pp. 585–600. [SRDB Ref ID: 35516]
- Hicks, H. G., 1984, *Results of Calculations of External Gamma Radiation Exposure Rates from Local Fallout and the Related Radionuclide Compositions of Selected U.S. Pacific Events*, UCRL-53505, University of California, Lawrence Livermore National Laboratory, Livermore, California, February. [SRDB Ref ID: 1856]

- IAEA (International Atomic Energy Agency), 1979, *Radiological Safety Aspects of the Operation of Electron Linear Accelerators*, Technical Reports Series No. 188, Vienna, Austria, March.
- IAEA (International Atomic Energy Agency), 1990, *Compendium of Neutron Spectra and Detector Responses for Radiation Protection Purposes*, Technical Reports Series No. 318, Vienna, Austria, July 26.
- IAEA (International Atomic Energy Agency), 2001, *Compendium of Neutron Spectra and Detector Responses for Radiation Protection Purposes, Supplement to Technical Reports Series No. 318*, Technical Reports Series 403, Vienna, Austria.
- ICRP (International Commission on Radiological Protection), 1987, *Data for Use in Protection Against External Radiation*, ICRP Publication 51, Pergamon Press.
- ICRP (International Commission on Radiological Protection), 1991, *1990 Recommendations of the International Commission on Radiological Protection*, Publication 60, Pergamon Press, Oxford, England.
- ICRU (International Commission on Radiation Units and Measurements), 1962, *Radiation Quantities and Units*, Report 10a, Bethesda, Maryland.
- ICRU (International Commission on Radiation Units and Measurements), 1988, *Determination of Dose Equivalents from External Radiation Sources—Part 2*, Report 43, Bethesda, Maryland, December 15.
- ICRU (International Commission on Radiation Units and Measurements), 1992, *Measurement of Dose Equivalents from External Photon and Electron Radiations*, Report 47, Bethesda, Maryland.
- ICRU (International Commission on Radiation Units and Measurements), 1993, *Quantities and Units in Radiation Protection Dosimetry*, Report 51, Bethesda, Maryland.
- ICRU (International Commission on Radiation Units and Measurements), 1998, *Conversion Coefficients for Use in Radiological Protection Against External Radiation*, Report 57, Bethesda, Maryland.
- ICRU (International Commission on Radiation Units and Measurements), 2001, *Determination of Operational Dose Equivalent Quantities for Neutrons*, Report 66, Bethesda, Maryland.
- Ing, H., and S. Makra, 1978, *Compendium of Neutron Spectra in Criticality Accident Dosimetry*, Technical Reports Series No. 180, International Atomic Energy Agency, Vienna, Austria.
- ISO (International Organization for Standardization), 2001, *Reference Neutron Radiations – Part 1: Characteristics and Methods of Production*, ISO/CD 8529-1, Geneva, Switzerland. [SRDB Ref ID: 13996]
- Kathren, R. L., 1967, "Dosimetry of 14-MeV Neutrons with Eastman NTA Personnel Monitoring Film," *Health Physics*, volume 13, number 9, pp. 1039–1040. [SRDB Ref ID: 25004]
- Kathren, R. L., 1987, "External Beta-Photon Dosimetry for Radiation Protection," *The Dosimetry of Ionizing Radiation, Volume II*, K. R. Kase and F. H. Attix, editors, pp. 321–370, Academic Press, New York, New York.

- Kathren, R. L., 2004, *Photon Doses and Energies at Selected Times following a Nuclear Detonation*, The Kathren Group, Richland, Washington, July 28. [SRDB Ref ID: 13997]
- Kathren, R. L., and H. V. Larson, 1969, "Radiological Calibration and Standardization for Health Physics: A Program, a Plea, and a Proposal," *Health Physics*, volume 16, pp. 778–782. [SRDB Ref ID: 13356]
- Kathren, R. L., C. T. Prevo, and S. Block, 1965, "Angular Dependence of Eastman Type A (NTA) Personnel Monitoring Film," *Health Physics*, volume 11, number 10, pp. 1067–1069. [SRDB Ref ID: 6180]
- Kathren, R. L., P. R. Zurakowski, and M. Covell, 1966, "Effect of Humidity and Dose on Personnel Monitoring Film," *American Industrial Hygiene Association Journal*, volume 27, pp. 388–395.
- Kean, W. B., 1951, *Exercise Desert Rock 1*, Headquarters, III Corps, Fort MacArthur, California. [SRDB Ref ID: 41176]
- Kocher, D. C., and K. F. Eckerman, 1981, "Electron Dose-Rate Conversion Factors for External Exposure of the Skin," *Health Physics*, volume 40, number 4, pp. 467–475.
- Kocher, D. C., and K. F. Eckerman, 1987, "Electron Dose-Rate Conversion Factors for External Exposure of the Skin from Uniformly Deposited Activity on the Body Surface," *Health Physics*, volume 53, number 2, pp. 135–141.
- Kulp, J. L., and J. L. Dick, 1960, "The Radiation Hazard from Contaminated Aircraft," *Health Physics*, volume 4, pp. 133–156.
- LANL (Los Alamos National Laboratory), 1994, "Final Hazard Analysis for Drillback Operations at the Nevada Test Site," memorandum, TPO-94-U-054, Los Alamos, New Mexico, February 14. [SRDB Ref ID: 40275]
- Lehman, R. L., 1961, *Energy Response and Physical Properties of NTA* Personnel Neutron Dosimeter Nuclear Track Film*, UCRL-9513, University of California, Lawrence Radiation Laboratory, Berkeley, California, January 13. [SRDB Ref ID: 14860]
- LRL (Lawrence Radiation Laboratory), 1964, "LRL Standard Operating Guide Postshot Drilling," memorandum, August 13. [SRDB Ref ID: 40276]
- LRL (Lawrence Radiation Laboratory), 1966, *Postshot Drilling Handbook*, UCID-15034, October. [SRDB Ref ID: 39413]
- Mayer, S., T. Otto, and N. Golnik, 2004, "Determination of the Photon-Contribution of a ²³⁸Pu-Be Source," *Nuclear Instruments and Methods in Physics Research*, volume B213, pp. 214-217.
- NCRP (National Council on Radiation Protection and Measurements), 1971, *Protection Against Neutron Radiation*, NCRP Report 38, Bethesda, Maryland, January 4. [SRDB Ref ID: 11520]
- NCRP (National Council on Radiation Protection and Measurements), 1978, *A Handbook of Radioactivity Measurements Procedures, 2nd Edition*, Report 58, Bethesda, Maryland.
- NCRP (National Council on Radiation Protection and Measurements), 1990, *Limit for Exposure to "Hot Particles" on the Skin*, Report 106, Washington, D.C.

- Nelms, A. T., and J. W. Cooper, 1959, "U-235 Fission Product Decay Spectra at Various Times After Fission," *Health Physics*, volume 1, number 4, pp. 427–441.
- NIOSH (National Institute for Occupational Safety and Health), 2006a, Special Exposure Cohort, Petition Evaluation Report Petition SEC-00055, Office of Compensation Analysis and Support, Cincinnati, Ohio, April 14.
- NIOSH (National Institute for Occupational Safety and Health), 2006b, *External Dose Reconstruction Implementation Guideline*, OCAS-IG-001, Rev. 2, Office of Compensation Analysis and Support, Cincinnati, Ohio, August 25. [SRDB Ref ID: 29929]
- NIOSH (National Institute for Occupational Safety and Health), 2007a, *Radiation Exposures Covered for Dose Reconstructions Under Part B of the Energy Employees Occupational Illness Compensation Program Act*, OCAS-IG-003, Rev. 0, Office of Compensation Analysis and Support, Cincinnati, Ohio, November 5. [SRDB Ref ID: 35987]
- NIOSH (National Institute for Occupational Safety and Health), 2007b, Special Exposure Cohort, Petition Evaluation Report Petition SEC-00084, Office of Compensation Analysis and Support, Cincinnati, Ohio, November. [SRDB Ref ID: 77699]
- NIOSH (National Institute for Occupational Safety and Health), 2010, Special Exposure Cohort, Petition Evaluation Report Petition SEC-00084 Revision 1, Office of Compensation Analysis and Support, Cincinnati, Ohio, January. [SRDB Ref ID: 77699]
- Norton, J. F., 2006, "Transuranic Waste Sub-Project Overview and Update," TRU/Mixed TRU Community Advisory Board Meeting, November 8. [SRDB Ref ID: 42681]
- NRC (National Research Council), 1989, *Film Badge Dosimetry in Atmospheric Nuclear Tests*, National Academy of Sciences, National Academy Press, Washington, D.C. [SRDB Ref ID: 1905]
- NRDL (Naval Radiological Defense Laboratory), 1968, *Hazards to Personnel Re-entering the Nevada Test Site Following Nuclear Reactor Tests*, NRDL-TR-68-149, San Francisco, California. [SRDB Ref ID: 8033]
- ORAUT (Oak Ridge Associated Universities Team), 2008a, *Nevada Test Site – Site Description*, ORAUT-TKBS-0008-2, Rev. 01 PC-1, Oak Ridge, Tennessee, May 27.
- ORAUT (Oak Ridge Associated Universities Team), 2005, *Interpretation of Dosimetry Data for Assignment of Shallow Dose*, ORAUT-OTIB-0017, Rev. 01, Oak Ridge, Tennessee, October 11.
- ORAUT (Oak Ridge Associated Universities Team), 2008b, *Nevada Test Site – Occupational Environmental Dose*, ORAUT-TKBS-0008-4, Rev. 01, Oak Ridge, Tennessee, May 27.
- ORAUT (Oak Ridge Associated Universities Team), 2008c, *Nevada Test Site – Occupational Internal Dose*, ORAUT-TKBS-0008-5, Rev. 01, Oak Ridge, Tennessee, May 28.
- ORAUT (Oak Ridge Associated Universities Team), 2006c, *External Dose Reconstruction*, ORAUT-PROC-0006, Rev. 01, Oak Ridge, Tennessee, June 5.
- ORAUT (Oak Ridge Associated Universities Team), 2007a, *Pantex Plant – Occupational External Dosimetry*, ORAUT-TKBS-0013-6, Rev. 01, Oak Ridge, Tennessee, June 22.

- ORAUT (Oak Ridge Associated Universities Team), 2007b, *Rocky Flats Plant – Occupational External Dosimetry*, ORAUT-TKBS-0011-6, Rev. 02, Oak Ridge, Tennessee, August 14.
- Provenzano, T. G., E. J. Story, F. F. Haywood, and H. T. Miller, 1965, *Feasibility Study: Intense 14-Mev Neutron Source For Operation HENRE*, CEX-65.01, U.S. Civil Effects Test Operations, AEC, Oak Ridge, Tennessee, September. [SRDB Ref ID: 40270]
- Pan Am (Pan American World Airways), 1967, *Final Proposal for TLD System at NRDS for the Space Nuclear Propulsion Office, Nevada Extension*, PAA 33-14, Pan American World Airways, September 15. [SRDB Ref ID: 13998]
- REECo (Reynolds Electrical and Engineering Company), 1961, *Standard Operating Procedures for the Radiological Safety Division*, RRS-61-3, Nevada Test Site, Mercury, Nevada, January. [SRDB Ref ID: 1922]
- REECo (Reynolds Electrical and Engineering Company), 1962, *Basic Radiological Safety Training Manual*, REECo-559:62-0140 (revision), Las Vegas, Nevada, January. [SRDB Ref ID: 1568]
- REECo (Reynolds Electrical and Engineering Company), 1968, "Section 29: Personnel Dosimetry and Records," *RadSafe Department Standard Operating Procedures*, Las Vegas, Nevada. [SRDB Ref ID: 2007]
- REECo (Reynolds Electrical and Engineering Company), 1985, "Determination of Radiokrypton and Radioxenon in Air," Section 7, *Environmental Sciences Department, Radioanalytical Laboratory Procedures*, Mercury, Nevada. [SRDB Ref ID: 13986]
- REECo (Reynolds Electrical and Engineering Company), 1990, *Procurement and Acceptance Criteria*, Standard Operating Procedure AABAC.D.02.40, Rev. 0, March 30. [SRDB Ref ID: 2054, p. 131]
- REECo (Reynolds Electrical and Engineering Company), 1995a, *Nevada Test Site Radiation Protection Program*, DOE/NV/11432-203, Rev. 3, Las Vegas, Nevada, December. [SRDB Ref ID: 14002]
- REECo (Reynolds Electrical and Engineering Company), 1995b, *Monthly Calibration of Gamma Radiation Fields at Inner and Outer Dosimeter Support Rings*, C34-6209-086.A, Las Vegas, Nevada, November 30. [SRDB Ref ID: 14006]
- REECo (Reynolds Electrical and Engineering Company), 1995c, *Thermoluminescent Dosimetry Quality Assessment*, C34-6209-039.A, Las Vegas, Nevada, November 30. [SRDB Ref ID: 14007]
- Roberts, R.B., 1937, "Investigation of the Deuteron-Deuteron Reaction", *Physical Review*, volume 51, number 10, pp. 810–817.
- Rollins, G., 2007, "NTS Radiation Protection Practices – 1966 to 1995," documented communication with B. Church (U.S. Department of Energy), Oak Ridge, Tennessee, October 17. [SRDB Ref ID: 36653]
- Sanders, F. W., J. A. Auxier, and J. S. Cheka, 1959, "A Simple Method of Minimizing the Energy Dependence of Pocket Ionization Chambers," *Health Physics*, volume 2, pp. 308–309.

- Sanders, F. W., F. F. Haywood, M. I. Lundin, L. W. Gilley, J. S. Cheka, and D. R. Ward, 1962, *Operation Plan and Hazards Report - Operation BREN*, CEX-62.02, U.S. Civil Effects Test Operations, AEC, Oak Ridge, Tennessee, January. [SRDB Ref ID: 37781]
- Sanna, R. S., J. E. McLaughlin, A. Lazanoff, and K. O'Brien, 1969, *Neutron Spectrometry: Operation HENRE (Program 6)*, CEX-65.60, U.S. Civil Effects Test Operations, AEC, Oak Ridge, Tennessee, January. [SRDB Ref ID: 39864]
- Schwartz, R. B., and C. M. Eisenhauer, 1980, *The Design and Construction of a D₂O-Moderator 252Cf Source for Calibrating Neutron Personnel Dosimeters Used at Nuclear Power Reactors*, NUREG-CR-1204, U.S. Nuclear Regulatory Commission, Washington, D.C. [SRDB Ref ID: 40273]
- Shipler, D. B., 2004, "Verification of Telephone Conversation with Dillard Shipler and Jerome Martin 8/17/04," letter to Robert Carr, Pacific Northwest National Laboratory, Richland, Washington, August 18. [SRDB Ref ID: 13481]
- Shipman, T. L., 1953, *Operation Buster-Jangle Radiological Safety*, WT-425(EX), University of California, Los Alamos Scientific Laboratory, Los Alamos, New Mexico, July (extracted version, October 1, 1979). [SRDB Ref ID: 2458]
- Shipman, T. L., et al., 1951, "Log of JM-4 operations, rad-safe group, Operation RANGER, Site Monitoring, 23 January to 11 February, 1951," Nellis Air Force Base, Las Vegas, Nevada. [SRDB Ref ID: 40278]
- Shleien, B., L. A. Slaback, Jr., and B. K. Birky, editors, 1998, *Handbook of Health Physics and Radiological Health, Third Edition*, Williams & Wilkins, Baltimore, Maryland, January.
- Sims, C. S., G. E. Ragan, 1987, *Health Physics Research Reactor Reference Dosimetry*, ORNL-6240, Oak Ridge National Laboratory, Tennessee, June. [SRDB Ref ID: 40368]
- Sondhaus, C. A., and V. P. Bond, 1955, *Physical Factors and Dosimetry in the Marshall Island Radiation Exposures*, WT-939, U.S. Naval Radiological Defense Laboratory, San Francisco, California, December. [SRDB Ref ID: 14876]
- Storm, E., 1951, memorandum to W. G. Kratz (Los Alamos Scientific Laboratory), Reynolds Electrical and Engineering Company, Las Vegas, Nevada, July 12. [SRDB Ref ID: 40279]
- Thierry-Chef, I., F. Pernicka, M. Marshall, E. Cardis, and P. Andreo, 2002, "Study of a Selection of 10 Historical Types of Dosimeter: Variation of the Response to Hp(10) with Photon Energy and Geometry of Exposure," *Radiation Protection Dosimetry*, volume 102, number 2, pp. 101–113. [SRDB Ref ID: 11296]
- Thorngate, J. H. and E. T. Loy, 1965, *Post Pulse Gamma-Radiation Spectrum: Operation BREN*, CEX-62.13, U.S. Civil Effects Test Operations, AEC, Oak Ridge, Tennessee, December. [SRDB Ref ID: 39846]
- Thorngate, J. H., J. A. Auxier, F. F. Haywood, and S. Helf, 1967, *Energy and Angular Distribution of Neutrons and Gamma Rays: Operation BREN*, CEX-62.12, U.S. Civil Effects Test Operations, AEC, Oak Ridge, Tennessee, January. [SRDB Ref ID: 39836]

- Thorngate, J. H., D. R. Johnson, P. T. Perdue, 1969, *Energy and Angular Distribution of Neutrons and Gamma Rays: Operation HENRE*, CEX-65.11, U.S. Civil Effects Test Operations, AEC, Oak Ridge, Tennessee, January. [SRDB Ref ID: 39863]
- Unger, L. M., and D. K. Trubey, 1981, *Specific Gamma-Ray Dose Constants for Nuclides Important to Dosimetry and Radiological Assessment*, ORNL/RSIC-45, Oak Ridge National Laboratory, Oak Ridge, Tennessee. [SRDB Ref ID: 40289]
- Wimett, T. F., 1965, *Fast Burst Reactors in the U.S.A.*, LA-DC-6786, Los Alamos National Laboratory, Los Alamos, New Mexico, January. [SRDB Ref ID: 40339]

GLOSSARY

absorbed dose, *D*

Amount of energy imparted by radiation to unit mass of absorbing material (100 ergs per gram), including tissue. The unit used before the use of the International System of metric units is the rad; the International System unit is the gray.

accreditation

Recognition that a dosimeter system has passed the performance criteria of the DOE Laboratory Accreditation Program standard in specified irradiation categories.

accuracy

If a series of measurements has small systematic errors, they are said to have high accuracy. The accuracy is represented by the bias.

albedo dosimeter

A TLD device that measures the thermal, intermediate, and fast neutrons that are scattered and moderated by the body from an incident fast neutron flux.

algorithm

A computational procedure.

Atomic Energy Commission

Original agency established for nuclear weapons and power production; a successor to the Manhattan Engineer District, and a predecessor to the U.S. Department of Energy and the Nuclear Regulatory Commission.

backscatter

Deflection of radiation by scattering processes through angles greater than 90 degrees with respect to the original direction of motion.

beta particle

A charged particle of very small mass emitted spontaneously from the nuclei of certain radioactive elements. Most (if not all) direct fission products emit (negative) beta particles. The beta particle is physically identical with an electron moving at high velocity.

buildup

Increase in flux or dose due to scattering in the medium.

calibration blank

A dosimeter that has not been exposed to a radiation source. The results from this dosimeter establish the dosimetry system baseline or zero dose value.

collective dose equivalent

The sum of the dose equivalents of all individuals in an exposed population. Collective dose is expressed in units of person-rem (person-sievert).

control dosimeter

A dosimeter used to establish the dosimetry system response to radiation dose. The dosimeter is exposed to a known amount of radiation.

curie

A special unit of activity. One curie exactly equals 3.7×10^{10} nuclear transitions per second.

deep absorbed dose (D_d)

The absorbed dose at the depth of 1.0 centimeter in a material of specified geometry and composition.

deep dose equivalent (H_d)

The dose equivalent at the respective depth of 1.0 centimeter in tissue.

densitometer

Instrument that has a photocell to determine the degree of darkening of developed photographic film.

density reading

See optical density.

DOE Laboratory Accreditation Program (DOELAP)

Accredits DOE site dosimetry programs based on performance testing and onsite reviews performed on a 2-year cycle.

dose equivalent (H)

The product of the absorbed dose D , the quality factor Q , and any other modifying factors. The special unit is the rem. When D is expressed in gray, H is in sieverts. (1 sievert = 100 rem.)

dosimeter

A device used to measure the quantity of radiation received. A holder with radiation-absorbing elements (filters) and an insert with radiation-sensitive elements packaged to provide a record of absorbed dose or dose equivalent received by an individual. (See *albedo dosimeter*, *film dosimeter*, *neutron film dosimeter*, *thermoluminescent dosimeter*.)

dosimetry system

A system used to assess dose equivalent from external radiation to the whole body, skin, and extremities. This includes the fabrication, assignment, and processing of dosimeters as well as interpretation and documentation of the results.

DuPont 552

A film packet containing two pieces of film: a 502 sensitive film and a 510 insensitive film.

DuPont 558

A film packet containing a 508 film with one side having a sensitive emulsion and the other side insensitive emulsion.

error

A term used to express the difference between the estimated and actual value.

exchange period (frequency)

Period (weekly, biweekly, monthly, quarterly, etc.) for routine exchange of dosimeters.

exposure

As used in the technical sense, a measure expressed in roentgens of the ionization produced by gamma (or X-) rays in air.

fast neutron

Neutron of energy between 10 kilovolts-electron and 10 megavolts-electron.

favorable to claimants

Process of estimation based on technical considerations of parameters significant to dose such that the estimated dose is not underestimated.

film

Generally means a film packet that contains one or more pieces of film in a light-tight wrapping. When developed the film has an image caused by radiation that can be measured using an optical densitometer. (See *DuPont 552*, *DuPont 558*, *nuclear track emulsion*)

film density

See *optical density*.

film dosimeter

A small packet of film in a holder that attaches to a worker.

filter

Material used to adjust radiation response of a dosimeter to provide an improved tissue equivalent or dose response.

first collision dose

A dose measurement that can be determined for photons or neutrons. For neutron radiation, the simplest calculation is one relating dose to flux through a thin layer of tissue. The resultant graph, sometimes referred to as the first-collision curve, is derived from the assumption that the probability of two or more interactions per neutron is negligible. Because of the short range of the charged secondary radiation from fast neutrons, the first collision dose in irradiated material is practically the same as the absorbed dose.

gamma rays

Electromagnetic radiation (photons) originating in atomic nuclei and accompanying many nuclear reactions (e.g., fission, radioactive decay, and neutron capture). Gamma rays are physically identical to X-rays of high energy; the only essential difference is that X-rays do not originate in the nucleus.

gamma ray interactions

Interaction of gamma rays with matter occurs through three primary processes as follows:

- **Photoelectric absorption**

The process whereby a gamma ray (or X-ray) photon, with energy somewhat greater than that of the binding energy of an electron in an atom, transfers all its energy to the electron, which is consequently removed from the atom.

- **Compton scattering**

An attenuation process observed for X-ray or gamma radiation in which an incident photon interacts with an orbital electron of an atom to produce a recoil electron and a scattered photon of energy less than the incident photon.

- **Pair production**

An absorption process for X-ray and gamma radiation in which the incident photon is annihilated in the vicinity of the nucleus of the absorbing atom, with subsequent production of an electron and positron pair. This reaction occurs only for incident photon energies that exceed 1.02 megavolts-electron.

gray

The International System unit of absorbed dose (1 gray = 100 rad).

intermediate-energy neutron

Neutron of energy between 0.5 electron volt (assumed to be 0.4 electron volt because of cadmium cutoff in neutron response) and 10 kilovolts-electron.

ionizing radiation

Electromagnetic radiation (consisting of photons) or particulate radiation (consisting of electrons, neutrons, protons, etc.) capable of producing charged particles through interactions with matter.

isotopes

Forms of the same element having identical chemical properties but different atomic masses. Isotopes of a given element all have the same number of protons in the nucleus but different numbers of neutrons. Some isotopes of an element can be radioactive.

kilovolt-electron (keV)

An amount of energy equal to 1,000 electron volts.

nuclear track emulsion, type A (NTA)

A film that is sensitive to fast neutrons. The developed image has tracks caused by neutrons that can be seen by using oil immersion and 1,000-power microscope.

luminescence

The emission of light from a material as a result of some excitation.

Manhattan Engineer District

Agency designated to develop nuclear weapons; a predecessor to the U.S. Department of Energy.

minimum detection level (MDL)

Often confused because statistical parameters necessary to its calculation are not explicitly defined. Nonetheless, the MDL is often assumed to be the level at which a dose is detected at the 2-sigma level (i.e., 95% of the time). The MDL should not be confused with the minimum recordable dose.

megavolt-electron (MeV)

An amount of energy equal to 1 million electron volts.

multiple-collision neutron dose

Dose to flux through tissue based on the assumption that two or more interactions per neutron occur resulting in greater energy deposition.

nuclear emulsion

Generally refers to Nuclear Track Emulsion, type A film.

neutron

A basic particle that is electrically neutral weighing nearly the same as the hydrogen atom.

neutron film dosimeter

A film dosimeter that contains a nuclear track emulsion, type A film packet.

nonpenetrating dose (NP or NPen)

Designation on film dosimeter reports that implies a radiation dose, typically to the skin of whole body, from beta and lower energy photon radiation.

open window (OW)

Designation on Hanford film dosimeter reports that implies the use of little shielding (only that of the security credential). It commonly is used to label the film response corresponding to the OW area.

optical density

The quantitative measurement of the density of photographic blackening defined as $D = \text{Log}_{10}(I_0/I)$.

pencil dosimeters

A type of ionization chamber used by personnel to measure radiation dose. These results might be labeled as Pen dose. Other names: pencil, pocket dosimeter, pocket pencil, pocket ionization chamber, PIC.

penetrating dose (P or Pen)

Designation on film dosimeter reports that implies a radiation dose, typically to the whole body, from higher energy photon radiation.

personal dose equivalent, $H_P(d)$

Radiation quantity recommended for use as the operational quantity to be recorded for radiological protection purposes by the International Commission on Radiological Units and Measurements. Represented by $H_P(d)$, where d identifies the depth (in millimeters) and represents the point of reference for dose in tissue. For weakly penetrating radiation of significance to skin dose, $d = 0.07$ millimeter and is noted as $H_P(0.07)$. For penetrating radiation of significance to whole-body dose, $d = 10$ millimeters and is noted as $H_P(10)$.

photon

A unit or particle of electromagnetic radiation consisting of X- and/or gamma rays.

quality factor (Q)

A modifying factor used to derive dose equivalent from absorbed dose.

rad

A unit of absorbed dose equal to the absorption of 100 ergs per gram of absorbing material, such as body tissue.

radiation

One or more of beta, neutron, and photon radiation.

radiation monitoring

Routine measurements and the estimation of the dose equivalent for the purpose of determining and controlling the dose received by workers.

radioactivity

The spontaneous emission of radiation, generally alpha or beta particles, gamma rays, and neutrons from unstable nuclei.

random errors

When a given measurement is repeated the resultant values, in general, do not agree exactly. The causes of the disagreement between the individual values must also be causes of their differing from the actual value. Errors resulting from these causes are called random errors.

relative biological effectiveness (RBE)

A ratio of the absorbed dose of a reference radiation to the absorbed dose of a test radiation producing the same biological effects, other conditions being equal.

rem

The rem is a unit of dose equivalent, which is equal to the product of the number of rads absorbed and the quality factor. The word derives from *roentgen equivalent in man*.

rep

Historically the rep has been used extensively for the specification of permissible doses of ionizing radiations other than X-rays or gamma rays. Several definitions have appeared in the literature but in the sense most widely adopted, it is a unit of absorbed dose with a magnitude of 93 ergs per gram. The word derives from *roentgen-equivalent-physical*.

roentgen

A unit of exposure to gamma (or X-ray) radiation. It is defined precisely as the quantity of gamma (or X-) rays that will produce a total charge of 2.58×10^{-4} coulomb in 1 kilogram of dry air. An exposure of 1 roentgen is approximately equivalent to an absorbed dose of 1 rad in soft tissue.

scattering

The diversion of radiation from its original path as a result of interactions with atoms between the source of the radiations and a point at some distance away. Scattered radiations are typically changed in direction and of lower energy than the original radiation.

shallow absorbed dose (D_s)

The absorbed dose at a depth of 0.07 millimeter in a material of specified geometry and composition.

shallow dose equivalent (H_s)

Dose equivalent at a depth of 0.07 millimeter in tissue.

shielding

Any material or obstruction that absorbs (or attenuates) radiation and thus tends to protect personnel or materials from radiation.

sievert

The International System unit for dose equivalent. (1 sievert = 100 rem.)

skin dose

Absorbed dose at a tissue depth of 7 milligrams per square centimeter.

thermal neutron

Strictly, neutrons in thermal equilibrium with surroundings. Generally, refers to neutrons of energy less than the cadmium cutoff of about 0.4 electron volt.

tissue-equivalent

Used to imply that radiation response characteristics of the material being irradiated are equivalent to tissue. Achieving a tissue-equivalent response is an important consideration in the design and fabrication of radiation measuring instruments and dosimeters.

thermoluminescent

Property of a material that causes it to emit light as a result of being excited by heat.

thermoluminescent dosimeter (TLD)

A holder containing solid chips of material that when heated will release the stored energy as light. The measurement of this light provides a measurement of absorbed dose. The solid chips are sometimes called crystals.

thermoluminescent dosimeter chip

A small block or crystal made of LiF used in the TLD.

TLD-600 - A TLD chip made from ^6Li (>95%) used to detect neutrons.

TLD-700 - A TLD chip made from ^7Li (>99.9%) used to detect photon and beta radiation.

whole-body dose

Absorbed dose at a tissue depth of 1.0 centimeter (1,000 milligrams per square centimeter); however, also used to refer to the dose recorded.

X-ray

Ionizing electromagnetic radiation of extranuclear origin.

**ATTACHMENT A
DOSIMETRY TECHNOLOGY**

Page 1 of 20

TABLE OF CONTENTS

<u>SECTION</u>	<u>TITLE</u>	<u>PAGE</u>
A.1	Beta/Gamma Dosimetry	88
A.1.1	Photographic Film Dosimeters.....	88
A.1.2	Thermoluminescent Dosimeters	91
A.1.2.1	NRDS Thermoluminescent Dosimeters.....	91
A.1.2.2	REEC _o Thermoluminescent Dosimeters	92
A.1.2.3	Energy Response.....	93
A.1.2.4	Dose Measurement.....	95
A.1.2.5	Calibration.....	95
A.2	Neutron Dosimetry	96
A.2.1	NTA Film	96
A.2.2	TLD Albedo Detectors	98
A.2.3	Track Etch Detectors	98
A.2.3.1	Dose Algorithms.....	100
A.3	Quality Assurance.....	101
A.4	Beta Particle Field Characteristics.....	102
A.5	Neutron Field Characteristics	104

A.1 BETA/GAMMA DOSIMETRY

A.1.1 Photographic Film Dosimeters

Photographic emulsions of various types and in various holders (i.e., film badges) were used at NTS for personnel monitoring from the start of operations in January 1951 until 1987 (DeMarre 2002; Allen and Schoengold 1995). The basic principles, theory, and practice of photographic film dosimetry for beta and photon radiation are well known and have been described in a number of standard texts and references (Becker 1966; Dudley 1966; Ehrlich 1954, 1962; Kathren 1987; NRC 1989). The following paragraphs discuss factors related to film dosimetry that provide a general background to the interpretation and reconstruction of dosimetry results at NTS.

The term *film badge*, or *film badge dosimeter*, as used in this document, refers to the entire dosimeter issued to personnel, which typically consisted of a dental-size film packet housed in a holder of varying sophistication designed to improve the response characteristics and measurement capabilities. The film consisted of a plastic base covered on one or both sides with a layer of a suitable photographic emulsion. One or two pieces of film were wrapped in a light-tight paper package to comprise the packet, which in turn was placed in a holder containing metallic filter(s) to compensate for the photon energy dependence of the film. The sensitivity of the film to ionizing radiation was largely a function of the size of the AgBr grains in the emulsion. Because the typical photographic emulsion for dosimetry has an effective range of about 3 orders of magnitude, the packet typically contained two pieces of film with different sensitivities. The effective ranges of these

ATTACHMENT A DOSIMETRY TECHNOLOGY

Page 2 of 20

films overlapped, which permitted an effective response range of about 5 orders of magnitude for penetrating photon radiations.

In principle, film dosimetry is simple; it consists of the determination of optical density or degree of blackening produced by exposure to radiation. The degree of blackening produced by the radiation incident on the film is determined in terms of the net optical density, the logarithm of which is typically plotted against the logarithm of *exposure* or dose to produce a calibration or response curve, or an algorithm with which the *exposure* registered by the film can be determined. The response of a film emulsion to photon radiation is not linear with dose or *exposure*. Near the lower (less than 50 mR) and upper (about 1.5 to 5 R) limits of the range of the film, small increments of density represent relatively large changes in dose. Therefore, the uncertainty at the low and high ends of the dose response curve (i.e., net optical density vs. *exposure*), where the slope is quite shallow, is relatively large. However, the total uncertainty for high-energy exposures (more than about 150 keV to 3 MeV) for these dose ranges (1.5 to 5 R) should not exceed a factor of 2. For high-energy photon *exposures* in the region of 50 to 1,500 mR (the steep portion of the dose response curve), the uncertainty is much less and should be within 20% to 30%. Dose reconstructors should consider these uncertainty values to be broad estimates, not exact values.

Although a number of different film types were used for dosimetry at NTS, they generally had similar characteristics and responses to beta and photon radiations. Uncertainties in dosimetry with these films are largely, if not exclusively, the result of external factors rather than differences in the films.

The response of film to photon radiation is affected by a number of interrelated variables. From the standpoint of dose reconstruction at NTS, the most important of these are energy dependence, angular dependence, and effects of temperature and humidity. Because of the high relative atomic number (Z) of the AgBr in the film emulsion in relation to soft tissue, the response or energy absorbed per unit *exposure* of the film is a strong function of the energy of the exposing photons, rising steeply at energies below about 200 keV to a peak at about 30 keV, and then falling off steeply. At about 30 keV, the energy of maximum response, the degree of blackening per unit *exposure* is about 30-fold greater than that for photons with energies of few hundred thousand to a few million electron volts. Because the relationship between *exposure* and soft tissue dose is approximately constant over a wide energy range, it was essential to compensate or correct for the energy dependence of the photographic response. This was accomplished by placing metallic filters over portions of the film to alter or flatten the energy dependence characteristics such that the film responded more like soft tissue over a wide energy range.

Although energy dependence can be a large source of error in film badge dosimetry, reasonably good results can be obtained by a four-element badge: one with an OW or no filter over a portion of the film packet, and high- Z , medium- Z , and low- Z filters over other portions of the packet. By observing the relationships of the degree of darkening under each filter area, and comparing these with exposures to known energies and doses of photon radiations, a reasonably accurate assessment of photon dose can be made over a wide range of energies. This is particularly true at NTS, where exposures were largely to photons with energies greater than a few hundred thousand electron volts at angles close to normal to the plane of the film. In general, errors in dose interpretation that result from energy dependence will result in overestimates of dose and are, therefore, conservative and favorable to claimants. However, given the single-element badges in use until 1966, some dose from lower energy photons, specifically those with energies below about 80 keV, could have been missed because of attenuation in the filter; therefore, the dose interpretation could be low. Given the photon energy spectra at NTS, any such loss of dose is likely to have been relatively low.

ATTACHMENT A DOSIMETRY TECHNOLOGY

Page 3 of 20

Photon calibration of film dosimeters was typically performed in terms of *exposure* in free air, with the plane of the film oriented normally to the direction of the incident photon beam. Initial calibrations were made with a high-energy photon source (e.g., ^{60}Co or ^{137}Cs) with an energy response by film similar to the energy spectra to which personnel were exposed in the field. After introduction of the advanced multielement film badge in January 1966, calibration was conducted with X-ray sources as well as high-energy photons. This enabled interpretation of *exposure* to the film with a higher degree of accuracy over a broader spectrum of photon energies.

The response of film, whether in a bare film packet or in a holder, is a function of the angle of incidence of the exposing radiation on the plane of the film. Because the film is in a small flat sheet, an edge-on exposure (i.e., an exposure with the incident radiation parallel to the plane of the film) produces a different effect or optical density pattern than an exposure normal (at right angles) to the plane of the film. The effect is strongly dependent on both the energy of the exposing photons and the type of film holder or film badge, but is generally minimal at photon energies above a few hundred thousand electron volts and for angles of incidence ranging from about 30 to 150 degrees in relation to the plane of the film. However, for angles of incidence approaching parallelism (i.e., 0 degrees) with the plane of the film, the effect can be pronounced, and can lead to significant underestimates in dose. The problem, however, should be more or less minimal for exposures at NTS because these were (1) typically to high-energy photons and at angles close to normal with the plane of the film and (2) probably largely accounted for in the interpretation of the badge.

Environmental conditions can significantly affect film badge results, and can result in large uncertainties and errors in dose estimation. Temperatures greater than 130°F (50°C) can induce fogging, but several days at this temperature are necessary before fogging or increased density occurs. At higher temperatures, which could have occurred in closed vehicles or buildings at NTS, fogging can result after shorter exposure times (Kathren, Zurakowski, and Covell 1966). If not corrected, high-temperature fogging always produces an overestimate and, therefore, a dose interpretation favorable to claimants.

High relative humidity results in a fading of the latent image before development and in a decrease in the measured density of the film for a given dose. Latent image fading results in a low estimate of dose. However, studies have shown that latent image fading is not a problem until films have been worn for intervals exceeding 4 to 6 wk, and can be largely overcome by encasing the film packet in a polyethylene pouch, as was done for hot and humid conditions encountered during nuclear tests in the Pacific (Kathren, Zurakowski, and Covell 1966). Given the low-humidity conditions at NTS, latent image fading is unlikely to be of significance to film dosimetry.

Films were exchanged at varying intervals and, once collected, were developed under controlled conditions. Optical densities were determined with a densitometer, and doses were determined from calibration curves, which were log-log plots of net optical density versus dose obtained from a series of films exposed to known levels of photons. The use of control films at sites such as the badge house, where there was no expectation of a radiation field other than from background, permitted the inherent density of the film and any density attributable to background radiation (the so-called background fog) to be subtracted from the reading, thereby providing the net optical density attributable to occupational exposure. In practice, background films were used to zero the densitometer, which then gave a net optical density reading.

ATTACHMENT A
DOSIMETRY TECHNOLOGY
Page 4 of 20

A.1.2 Thermoluminescent Dosimeters

A.1.2.1 NRDS Thermoluminescent Dosimeters

The first routine use of TLDs at NTS began in 1970 (Boone, Bennett, and Adams 1970). Starting in February 1966, Pan Am used TLDs at the NRDS as part of the site effluent monitoring program. These dosimeters contained a calcium-fluoride phosphor bound to a helically wound wire in an evacuated glass tube and were ideal for the intended purpose but unsuitable for personnel dosimetry (Boone, Bennett, and Adams 1970).

Other installations had successfully demonstrated the applicability of LiF TLDs for personnel dosimetry (Boone, Bennett, and Adams 1970). A brief investigation was performed and proposals submitted for institution of a LiF TLD program at NRDS in 1967 to complement the REECo-supplied personnel film dosimetry service.

On July 1, 1968, Pan Am initiated a TLD program at the NRDS with the cooperation of the Health Services Laboratory of the AEC Idaho Operations Office (IDO). This laboratory supplied LiF TLD chips and provided readout services and considerable consultation based on its extensive LiF TLD experience at the National Reactor Testing Station. From July 1, 1968, until July 1970 NRDS personnel who were not likely to receive a significant exposure received TLDs. All reported exposures were in the background range (0 to 30 mrem). Routine use of TLDs began in July 1970 and continued until the NRDS ceased operation at the end of 1972 (Boone, Bennett, and Adams 1970; DOE 2002).

Beginning in July 1970 (and repeated every quarter thereafter), a minimum of one set of dosimeters was exposed on the Pan Am Calibration Range to a total dose(s) of from 100 mR to 5 R. Each set of dosimeters consisted of 1 Pan Am R-chamber, 6 REECo film, and 12 IDO TLD chips (6 to be read out at Pan Am and 6 at IDO). The Pan Am Calibration Range was crosschecked against Pan Am R-chambers, which were calibrated by NBS (one set was sent to NBS annually). If the difference between the range and the R-chamber exceeded $\pm 6\%$, the data points were retaken (Boone, Bennett, and Adams 1970).

A calibration factor was calculated for each type of dosimeter as follows:

$$CF = \frac{D_x - D_o}{R} \tag{A-1}$$

where:

- CF* = calibration factor
- D_x* = mean indicated dose from the set of six exposed dosimeters
- D_o* = mean indicated dose from the set of six unexposed dosimeters
- R* = R-chamber indicated dose.

As long as the average calibration factor over the dose range of interest fell in the range of 0.9 to 1.1 ($\pm 10\%$), the results were documented but no further action was taken because this level of accuracy was considered adequate. If the average calibration factor fell outside this range, the parties concerned were notified and another set of data was taken. In general, the relative accuracy of both

ATTACHMENT A
DOSIMETRY TECHNOLOGY

Page 5 of 20

measurement systems, as indicated by the body of data considered, is adequate for personnel dosimetry purposes.

In the case of Pan Am-read TLDs, a calibration factor was always necessary due to the relative response of the reader. The appropriate calibration factor was employed as follows:

$$D_c = CF \times (D_i - D_o) \quad (A-2)$$

where:

D_c = calibration factor

D_o = actual dose

D_i = indicated dose

Boone, Bennett, and Adams (1970) contains additional information on calibrations and calibration comparisons between Pan Am, IDO, and REECo.

Figure 6-2 shows the security badge and enclosed TLD insert. It was a plastic holder in which two LiF dosimeters were placed. One dosimeter was shielded by the tantalum-cadmium filter area of the present badge. The other dosimeter was unshielded. The two dosimeters were held in place by retainers built into the insert (for pliable LiF-Teflon discs) or hinged retainers (for extruded LiF chips). The insert was punched with a binary code that identified security badges for issuance and collection. Finally, the bottom left-hand portion of the dosimeter insert was coded to enable security guards to determine if dosimeters were being worn for the proper period.

A.1.2.2 REECo Thermoluminescent Dosimeters

With the advent of DOE requirements to restrict personnel exposures to ALARA and with emphasis on accurate dosimetry at low doses, REECo Environmental Sciences Department personnel began evaluating TLD systems and neutron dosimeters in the early 1980s to replace the film badge and neutron TLD (Allen and Schoengold 1995).

After evaluating several dosimetry systems, the Environmental Sciences Department determined that the Panasonic 802 TLD and the neutron TED were the best combination for NTS exposure conditions. These were put into use January 1, 1987. The security credential holder was redesigned to accommodate both dosimeters (Figures 6-3 and 6-4).

DOE Order 5480.11, "Radiation Protection for Occupational Workers" (DOE 1988), established the radiation protection standards and program for DOE, its contractor personnel, and other occupational personnel to protect workers from ionizing radiation. It defined policies and procedures required to operate DOE facilities and conduct activities to keep personnel exposures well below the limits set by Order 5480.11 to meet ALARA goals. The site-specific Nevada Operations Office/Yucca Mountain Project (YMP) Radiological Control Manual (known as the RadCon Manual; DOE 1994) describes radiation protection standards and program requirements as they relate to the NTS and YMP organizations. The Nevada Test Site Radiation Protection Program, published in May 1995 (REECo 1995a), demonstrated compliance with DOE rules for protecting individuals from ionizing radiation.

The four-element Panasonic UD-802 TLD was the primary dosimeter for routine use issued to all monitored personnel until 2001, when it was replaced by the Panasonic 809 dosimeter, which also

ATTACHMENT A
DOSIMETRY TECHNOLOGY
Page 6 of 20

contained four elements (Table 6-1). The Panasonic UD-807 TLD is used to monitor personnel working in situations where the likelihood of exposure to an extremity is significantly greater than exposure to the whole body.

In most instances, dosimeters (i.e., TLDs) were processed quarterly. Some personnel working in locations where high exposures were more likely to occur exchanged their dosimeters monthly. The NTS monitoring program was designed to ensure that personnel exposures were kept below the annual limit of a total effective dose equivalent of 5 rem.

The Panasonic UD-802 TLD was designed to identify the type and energy of detected radiation, so the prescribed tissue depth dose equivalents could be determined accurately. In specific, the four-element Panasonic 802 was intended to measure the following:

- External photon radiation from 0.010 to 1,000 rem
- Gamma energy range of 0.010 to 10 MeV
- Beta radiation from 0.030 to 1,000 rad
- Beta energy range from approximately 0.30 to 10 MeV

Table A-1 lists TLD element composition, filtration, and radiation type.

Table A-1. Panasonic UD-802 dosimeter configuration (Allen and Schoengold 1995).

Element	Phosphor	Filtration	Rad. type & dose equivalent
E1	Li ₂ B ₄ O ₇ :Cu	Teflon/polyester, 18 mg/cm ²	Gamma, beta, shallow dose
E2	Li ₂ B ₄ O ₇ :Cu	Teflon/polyester and plastics, 70 mg/cm ²	Gamma, beta, eye dose
E3	CaSO ₄ :Tm	Teflon/polyester, ABS plastics, and Black ceramic, 645 mg/cm ²	Gamma
E4	CaSO ₄ :Tm	Teflon/polyester, ABS and lead, 1,042 mg/cm ²	Gamma, deep dose

The dosimeters were calibrated against known exposures to provide an accurate transition from measured exposure to dose equivalent. Dosimeter calibration factors were normalized to the corrected readings from run calibration factor (RCF) dosimeters processed with the field dosimeters. The computer program separated the calibration dosimeters, used the known RCF exposure value, and calculated RCFs that were applied to the remainder of the dosimeters in the run. The RCFs kept a reader in calibration over long periods and maintained consistency among different readers (Allen and Schoengold 1995).

A.1.2.3 Energy Response

Panasonic UD-802 and UD-809 TLD elements have well-known energy responses (Allen and Schoengold 1995) [40]. Like many radiation detection devices, there is an energy (about 20 keV) below which radiation does not deliver sufficient energy to the TLD element for detection. As photon radiation energy increases, the Li₂B₄O₇:Cu elements have a relatively flat response, while the CaSO₄:Tm elements over-respond between about 50 and 200 keV. The higher CaSO₄:Tm response is due primarily to the effective Z of 14.4 for CaSO₄, compared to 7.3 for Li₂B₄O₇:Cu. The lithium borate effective Z is much closer to the effective Z for tissue (7.4), and this relationship is important to photoelectric effect interactions. The response of both types of elements is relatively flat to about 5 MeV, where the CaSO₄ response increases slightly due to its higher effective Z and, in this case, pair production interactions. Figure A-1 shows typical photon energy response curves for Li₂B₄O₇ and

ATTACHMENT A DOSIMETRY TECHNOLOGY

Page 7 of 20

CaSO₄ TLD elements. Figure A-2 shows the response for the UD-802 TLD, including filters. The first element in the UD-802 TLD has a total filtration density depth of about 18 mg/cm², making it sensitive to beta particle radiation with energies of 100 keV or more. The second element responds to beta radiation with energies above about 300 keV. Because beta particles have a low linear energy transfer and the Li₂B₄O₇ is nearly equivalent to tissue, the beta energy response is relatively flat and similar to the photon response shown in Figure A-2 for photon radiation (starting at 0.1 MeV for element E1 and 0.3 MeV for element E2).

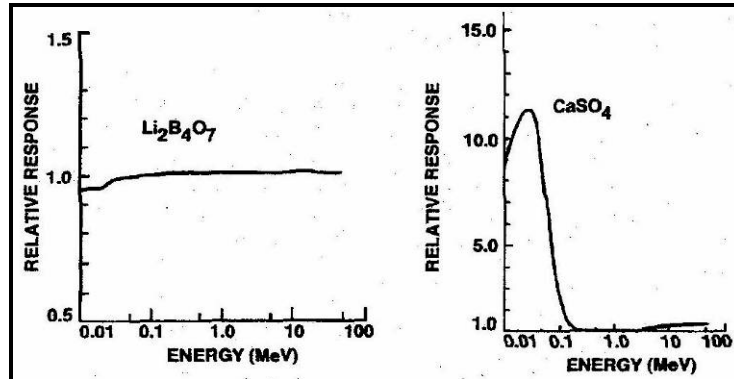

Figure A-1. Typical photon energy response curves for Li₂B₄O₇ and CaSO₄ TLD elements (Allen and Schoengold 1995).

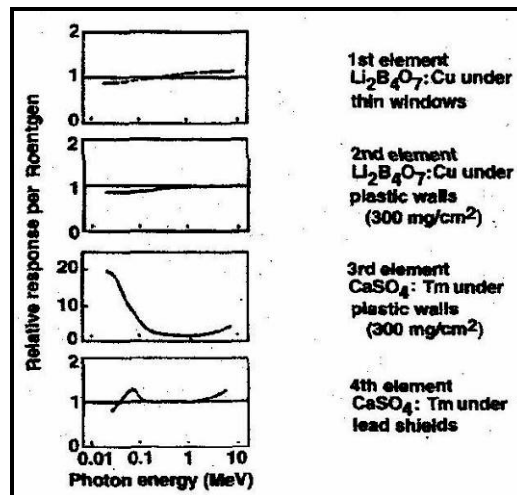

Figure A-2. Panasonic UD-802 energy responses (Allen and Schoengold 1995).

NTS algorithms identify radiation types and energies and then apply factors necessary to obtain a correct dose equivalent from a TLD reading. Thus, the energy response characteristics of the UD-802 TLD, over the useable range of the TLD, are automatically factored into the dose equivalent determination. The validity of the algorithms for energy response correction is verified through the satisfactory completion of DOELAP accreditation for photon and beta particle radiation in several different radiation energy categories (Allen and Schoengold 1995).

ATTACHMENT A
DOSIMETRY TECHNOLOGY
Page 8 of 20

Unlike the Panasonic UD-802, the UD-809 introduced in 2001 has four lithium borate ($\text{Li}_2\text{B}_4\text{O}_7(\text{Cu})$). One uses lithium, enriched to 99.99% in ^7Li and ^{11}B , both of which have a negligible neutron response. The other three employ neutron-sensitive $^6\text{Li}_2^{10}\text{B}_4\text{O}_7(\text{Cu})$ chips, with ^6Li enriched to 95.33% and ^{10}B enriched to 94.64%. These two isotopes have high n, alpha cross sections. The elements are shielded with tin and cadmium on front and back, in various combinations [41].

A.1.2.4 Dose Measurement

The background, element correction factor (ECF), and RCF corrected measurements from TLD elements provide an indication of the dose received by the person wearing the dosimeter. However, because TLDs are not truly tissue equivalent in relation to dose equivalent, algorithms are used to convert the dosimeter response to a dose equivalent value at the specific depth in tissue (Allen and Schoengold 1995).

The NTS algorithms were developed by irradiating TLDs mounted on a phantom of tissue substitute to specific radiation quantities and types (Allen and Schoengold 1995). The dosimeter measurement was compared to the dose equivalent calculated by knowing the type and energy of the radiation. This process was repeated many times until enough data were collected to develop equations and relationships between a dosimetric reading and the dose equivalent at the specified depth in tissue. Published factors for converting radiation exposure to dose equivalent were used in the development of the algorithms. Table A-2 lists exposure to dose equivalent conversion factors specified in the DOELAP Standard for NIST reference photon fields.

Table A-2. Photon exposure to dose conversion factors for NIST reference radiations.^a

NIST reference radiation	Conversion factor (mrem/R)	
	Shallow (0.07 mm)	Deep (10 mm)
Filtered X-rays		
M30	1.08	0.45
S60	1.15	1.07
M150	1.41	1.47
H150	1.41	1.41
K-fluorescence X-ray (keV)		
16	1.08	0.38
24	1.07	0.47
34	1.07	0.99
43	1.28	1.30
58	1.47	1.54
78	1.61	1.72
100	1.59	1.74
Cesium-137 photon (keV)		
662	1.03	1.03

a. Source: Allen and Schoengold (1995).

A.1.2.5 Calibration

Several Quality Assurance (QA) operations are performed on new dosimeters before they are approved for field use. The numerical coding on each TLD label is verified to ensure accurate tracking. Before use, and annually thereafter, dosimeter phosphor elements are calibrated by

ATTACHMENT A DOSIMETRY TECHNOLOGY

Page 9 of 20

determining an ECF for each element. In accordance with applicable procedures, a dosimeter with an ECF out of tolerance is removed from use.

TLDs are calibrated with the NTS ^{137}Cs gamma source calibration range. The ^{137}Cs source is traceable to NIST through a secondary standard calibrated ion chamber. An integrating electrometer, calibrated annually for NIST traceability, is used to verify the accuracy of each TLD and TLD reader calibration exposure. All temperature and barometric pressure measuring instruments used for the calibration range are calibrated annually to NIST traceable standards.

Monthly Calibration of Gamma Radiation Fields at Inner and Outer Dosimeter Support Rings (REECo 1995b) outlines procedures for performing gamma source exposures. The results of the exposures are used to ensure proper performance of the gamma sources, provide required exposure rate information to upgrade source calibration, and document exposure trends for quality control (QC).

A.2 NEUTRON DOSIMETRY

A.2.1 NTA Film

Fast neutrons interact with the hydrogen in the NTA emulsion and film, producing recoil protons that, having kinetic energy and being charged, travel through the emulsion, creating a string of exposed individual grains of AgBr along their path (Lehman 1951). On development, these show up as tracks of grains of developed AgBr. Track length is a function of the energy of the recoil proton and the angle of travel with respect to the plane of the film. Fast neutron dose is determined by direct visual counting, usually via a microscope, of the number of proton recoil tracks in a predetermined (for statistical purposes) number of microscope fields, usually 100. A countable track must have a length of at least three grains (i.e., there must be three grains in a row for a track to be registered).

Tracks can be produced in NTA film emulsion either by protons produced by the $^{14}\text{N}(n,p)$ reaction with low-energy neutrons (less than 10 eV) or by direct recoils from energetic neutron interactions with hydrogen in the film. The relatively low thermal neutron fluences, the low (n,p) reaction cross-section, and the large fluence of thermal neutrons per millirem compared to fast neutrons (2,200 compared to 7.5) rendered thermal neutron dosimetry impractical.

Based on theoretical considerations, a minimum neutron energy of about 450 keV is needed to produce a proton recoil track, although in practice the minimum detectable energy or threshold energy was about 800 keV (Figure A-3). Thus, NTA film is essentially insensitive to neutrons below 500 to 800 keV, depending on the quality of processing. Therefore, it is suitable only for occupational environments in which the majority of the dose comes from neutrons with energies above 1 MeV, or in which the fraction of neutrons below 1 MeV is reasonably well known. It is important to calibrate NTA film dosimeters with a source having a neutron energy spectrum similar to that in which the individual could be exposed. Initially, a PuBe neutron spectrum was used for calibration. The PuBe neutron spectrum has an average energy of about 4 MeV and is considerably richer in fast neutrons than the fission spectrum (with average energy of about 1 MeV), and so is likely to result in a calibration factor (i.e., tracks/cm²-n) that would underestimate the fast neutron dose [42]. Any moderation of the fission spectrum encountered under field conditions would further exacerbate the underestimate.

NTA film has a number of severe limitations that lead to large uncertainties in neutron dosimetry. As noted, the response of NTA film was highly dependent on neutron energy and angle of incidence with respect to the plane of the film (Cheka 1954; Lehman 1951; Kathren, Prevo, and Block 1965; Kathren

ATTACHMENT A DOSIMETRY TECHNOLOGY

Page 10 of 20

1967). Another limitation of NTA film is its use dose range. The LLD for fast neutrons typically corresponds to a dose of about 100 mrem. For fast neutron fluences corresponding to a few rem, the track density becomes so great that accurate dosimetry becomes difficult if not impossible.

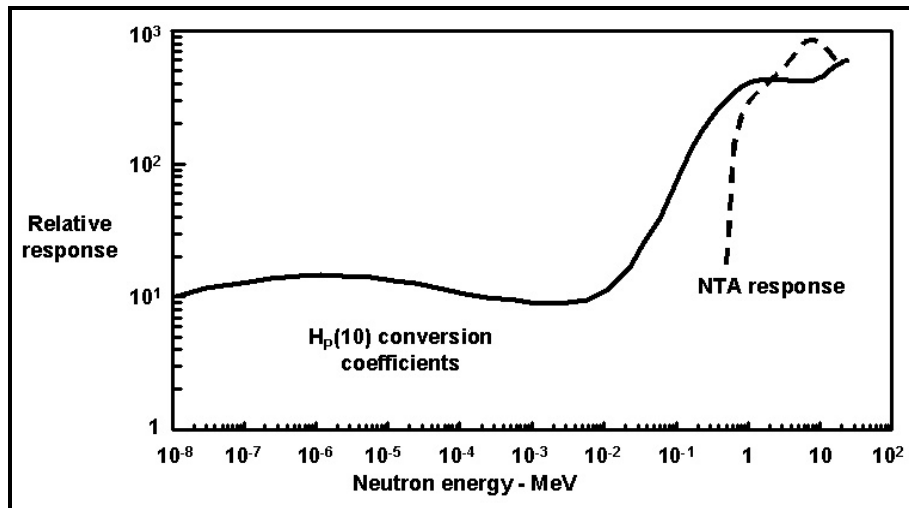

Figure A-3. NTA film neutron energy response (IAEA 1990).

NTA films respond to other radiation qualities (photons, betas, etc.). Concomitant photon dose, which results in film blackening, can render track counting difficult, introduce errors and, if the optical density produced by the photon exposure is sufficiently great, obscure proton recoil tracks altogether. Track counting itself is questionable; different persons given identical sections of an exposed NTA film to count often produce highly variable track counts. It has been long recognized that, in the dosimetry laboratory, human factors associated with reading large numbers of neutron films under a microscope can significantly affect neutron dosimetry results. Research conducted at the Rocky Flats Plant in 1994 reevaluated neutron doses for selected plutonium workers (ORAUT 2007b). This research indicated that the original evaluations of films could have contained significant errors and that the resulting neutron doses could be significantly higher or lower than the doses actually received. The degree of variation is a function of the track length and the personal style of the individual doing the counting. Uncertainty from this source alone could easily be as great as a factor of 2.

The latent image produced by proton recoil tracks in NTA film is highly susceptible to fading before development. Fading is a function of time after exposure and is particularly severe in high humidity (as much as 75%/wk) but can be minimized and largely controlled if the films are sealed in a moisture-proof pouch before use. Humidity-induced latent image fading is probably not a significant source of uncertainty or dose underestimation at NTS because of the low humidity, although some latent image fading is likely if the wearing interval exceeds a month.

Given these limitations, neutron dose estimates made with NTA film are likely to have a high degree of uncertainty and generally will underestimate the actual dose from fast neutrons. As noted in Table 6-1, this leads to the application of a bias for neutron data obtained with NTA film when detailed information about the neutron fields is not available (see Section 6.3.4.3).

ATTACHMENT A DOSIMETRY TECHNOLOGY

Page 11 of 20

A.2.2 TLD Albedo Detectors

The primary advantages of TLD albedo dosimeters are the high sensitivity compared to NTA film and the availability of automated TLD readers for rapid reading. The primary disadvantage is that the energy response does not match the personal dose equivalent response, so they are highly energy-dependent (Figure A-4). The energy response can be improved slightly by dosimeter encapsulation, as used in the NTS dosimeter design. However, the response is still highly dependent on the neutron spectrum.

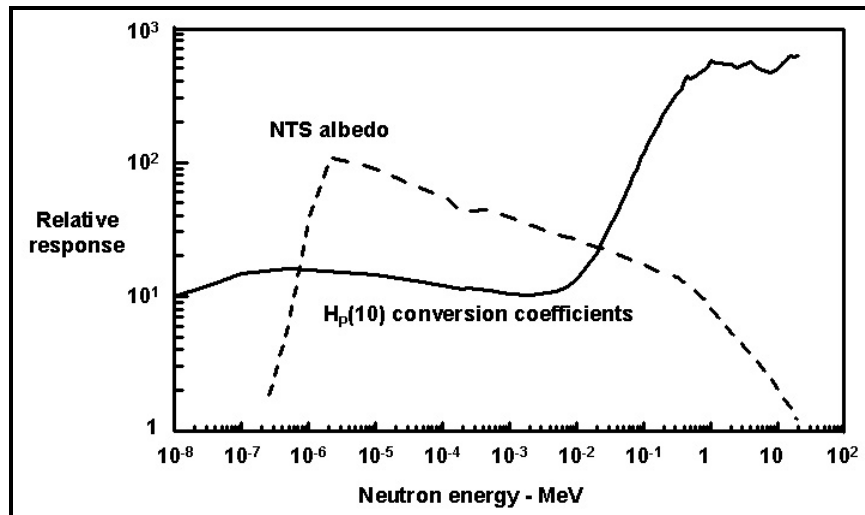

Figure A-4. Neutron energy response of NTS albedo dosimeters (IAEA 1990).

For albedo dosimeters, neutron fields can be put in four categories based on their relative spectra characteristics: (1) reactors, linear accelerators, and accelerators for medical therapy; (2) nuclear fuel fabrication areas; (3) radioactive neutron sources; and (4) high-energy accelerators with little or no shielding. Within a neutron spectral class, neutron response relative to $H_p(10)$ does not vary by more than a factor of 2. The large energy dependence is still a big disadvantage. The advantage to TLD albedo detectors, compared to film and to a lesser degree CR-39, is that they detect neutrons of all energies and have simple automatic TLD readouts.

Calibration curves have been established for working areas that can reduce workplace-dependent changes of albedo response within $\pm 30\%$. Depending on the neutron field, the lowest detectable dose using albedo TLDs varies from 5 to 20 mrem. Albedo dosimeters can be combined with TEDs for separate measurement of fast neutrons. In a combination detector, the albedo detector serves as the basic neutron detector for screening.

A.2.3 Track Etch Detectors

The TED is a dosimetry-grade polymer called CR-39. When fast neutrons interact with the plastic, submicroscopic damage trails are created. These trails can be enlarged using chemical etching techniques to form tracks visible under a 400-power microscope. The tracks can be made more visible using electrochemical etching that causes breakdown to form subsurface trees that are easily counted under low magnification (Griffith and Tommasino 1990).

ATTACHMENT A DOSIMETRY TECHNOLOGY

Page 12 of 20

The NTS TED dosimeter consists of three CR-39 foils (i.e., individual dosimeter pieces), cut from 0.025-in. (0.0635-cm)-thick sheets covered on both sides with 0.005-in.-thick polyethylene film. They are heat sealed under an opaque blister to a plasticized card. A bar code label is applied, and (for personnel service) the assembly is placed in a cavity in the NTS Personnel Dosimeter.

A three-step etching process is used to develop the damage tracks that result from neutron interactions. After removing the polyethylene film, the track detectors are first etched for 45 min at 60°C in 6.5N KOH. This is followed by the electrochemical etching step. An alternating potential of 3 kV is applied across the track detector in the etch bath at a frequency of 60 Hz for 3 hr. The resultant tracks are amplified, forming “trees” under the track detector surface. A third step using 3 kV but at 2,000 Hz produces tracks that are more uniform and easily recognized as tracks. The final step is referred to as the *blow-up stage* of the process. This produces well-defined round or elliptical holes large enough to be seen and counted with low (4-power) magnification. The tracks are recorded with a television camera interfaced to a commercial bacteria colony counter that can be used to count several standard 0.09-cm² fields. The dose equivalent is determined by a software program that converts the number of foil net tracks to a dose equivalent.

The TEDs were initially calibrated with an unmoderated ²⁵²Cf source at Pacific Northwest Laboratories. Secondary calibration is provided by the NTS ²³⁸PuBe neutron source. Secondary calibration-check TED foils are processed with each batch of personnel monitoring foils to determine the RCF for the processing run. Primary and secondary calibration data are recorded in units of millirem per track per square centimeter in the TED program. The tracks from the calibration check foils processed with each batch of foils are compared to the primary and secondary calibration data to determine the dose equivalent conversion factor for the process batch. The energy response of the NTS track etch dosimeters is shown in Figure A-5.

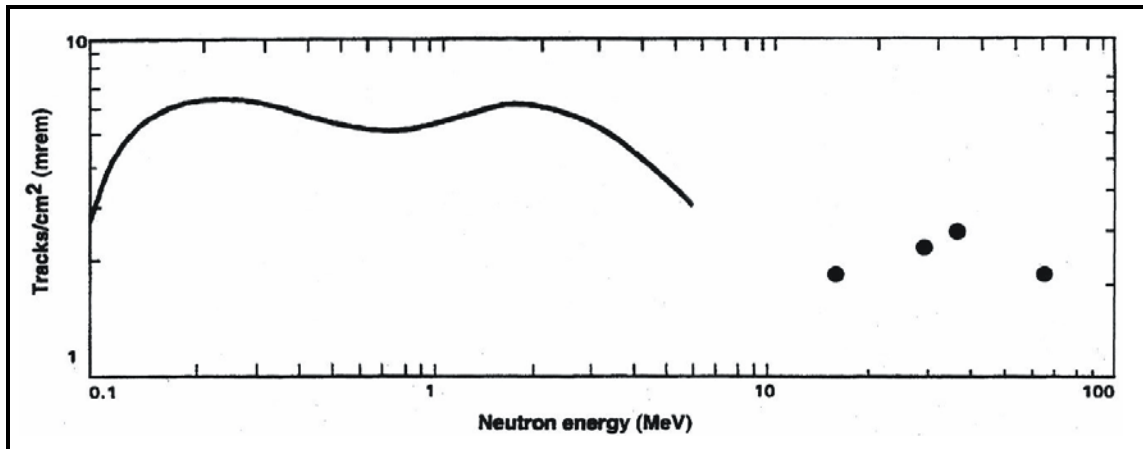

Figure A-5. Neutron energy response of NTS TED (Allen and Schoengold 1995).

Background exposure is subtracted from TED results to eliminate the TED exposure that is not part of the individual's occupational dose. The natural or background neutron radiation level is extremely low and, therefore, NTS uses the standard practice of using control TEDs. Control TEDs are prepared along with batches of TEDs for issue and are retained in the low-background dosimetry operations facility until the corresponding personnel TEDs are processed. Control, calibration-check, and personnel foils are processed together, and the number of tracks in control foils is subtracted from the number of tracks in personnel and calibration-check foils. The calibration-check results are used to determine the correct dose equivalent calibration factor.

ATTACHMENT A DOSIMETRY TECHNOLOGY

Page 13 of 20

A.2.3.1 Dose Algorithms

The CR-39 TED is known to have a nonlinear response, with the observed or measured dose equivalent being a slight over-response in comparison with the delivered dose equivalent for low doses, then changing to an under-response as the dose increases. Because the nonlinearity can vary with CR-39 processing methods, specific data for the NTS TED system were collected. A series of TED exposures was made using an unmoderated PuBe source and appropriate conversion factors relating the source to an equivalent unmoderated ^{252}Cf source. Two TEDs (six foils) each were exposed to 12 dose equivalents between 130 and 6,505 mrem. The results ranged from 126 to 2,930 mrem, as shown in Figure A-6.

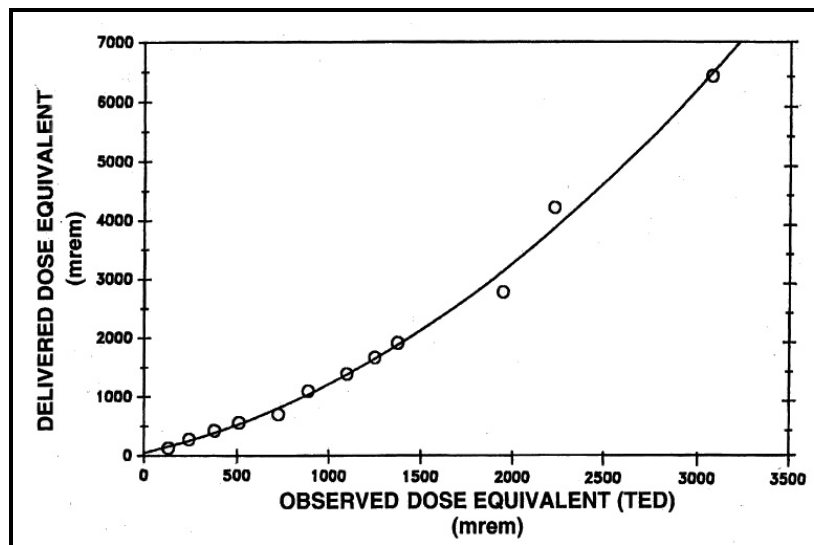

Figure A-6. Electrochemically etched CR-39 dose response (Allen and Schoengold 1995).

TED algorithms were developed by exposing many TEDs to calibrated neutron exposures and comparing processed results with calculated and known dose equivalents. Irradiations ranging from about 100 to 7,000 mrem were used to determine the shape of the curve relating true dose equivalent to observed dose. Linear regression analysis of the data pairs (true and observed dose) showed that a second-degree polynomial fit the relationship between true dose equivalent and indicated for uncorrected dose equivalent. That polynomial, shown below, is the algorithm used by the TED program to calculate the neutron dose equivalent H_T from the TED uncorrected dose equivalent H_i :

$$H_T = 0.77H_i + 0.000459H_i^2 \quad (\text{A-3})$$

H_i in the above equation is calculated by the TED program from the number of net tracks and the millirem to track calibration factors.

Because the Panasonic UD-802 TLD has a very slight response to neutrons, two algorithms are necessary to determine dose equivalent when exposure includes photons and neutrons. One algorithm corrects TLD response for neutron interference; the other converts TED results to dose equivalent. The deep dose equivalent is the sum of the deep dose from photons and the dose from neutrons. Therefore, in all neutron exposure cases, a TLD evaluation is performed to determine the deep dose from photons.

ATTACHMENT A DOSIMETRY TECHNOLOGY

Page 14 of 20

A.3 QUALITY ASSURANCE

The QA program was established and has been maintained through adherence to QC procedures and practices. As required by DOE rules for protecting individuals from ionizing radiation, the program includes internal audits at intervals of 3 yr or less. The QC personnel for the external dosimetry program monitor and test program operations, data records, and performance. The effectiveness of the QA program is demonstrated through satisfactory completion and maintenance of DOELAP accreditation (Allen and Schoengold 1995).

Dosimeters are carefully tested before being put into use, and their performance is routinely monitored. Acceptable processing and recording equipment calibration and operation is verified by internal QA reviews and by participation in external assessments. For example, REECo Health Protection Department procedure, *Thermoluminescent Dosimeter Quality Assessment* (REECo 1995c), outlines the methods for assessment of the performance and adequacy of TLD issuing, processing, and reporting techniques.

The NTS external dosimetry program was one of the early programs accredited by DOE. Accreditation was initially requested in 1989 and updated in 1990. The onsite assessment was conducted in 1991, and accreditation was granted in 1992. DOELAP accreditation requires that dosimetry operations satisfy specific standards for accuracy of measurements, records, reports, and QA activities.

The NTS external dosimetry program has maintained accreditation in the following DOELAP categories:

- I. Low-energy photon (high dose)
- II. High-energy photon (high dose)
- IIIA. Low-energy photon
- IIIB. Low-energy photon (plutonium)
- IV. High-energy photon
- VA. Beta
- VI. Neutrons (unmoderated, ^{252}Cf)
- VII. Mixtures
 - III + IV
 - III + VA
 - IV + VA
 - III + VI
 - IV + VI

The accredited categories are based on possible accident scenarios and probable operational exposure conditions at NTS and include all DOELAP categories except two, which were omitted because:

- Category VB, "Beta Particles - Special" – uranium exposure environment does not exist at NTS. Therefore, TLDs have not been calibrated for dose measurements for beta particle radiation from natural or depleted uranium slabs.
- Category VI, "Neutron ^{252}Cf (moderated)" – the unmoderated neutron category more closely approximates the neutron energy spectra in the NTS occupational environment.

ATTACHMENT A
DOSIMETRY TECHNOLOGY
Page 15 of 20

The bias values and uncertainties in Table A-3 are based on DOELAP performance testing for TLD systems within 30% at an approximate 95% confidence level (Allen and Schoengold 1995).

Table A-3. Bias values and uncertainties for NTS DOELAP accreditation categories (Allen and Schoengold 1995).

Category		Bias(B) and standard deviation (S) (mrem)			
		Deep dose		Shallow dose	
		B	S	B	S
I.	Low-energy photons (X-ray) – high dose	0.036	0.065	N/A ^a	N/A
II.	High-energy photons – high dose	0.046	0.070	N/A	N/A
IIIa.	Low-energy photons (X-ray) – general	0.001	0.117	0.03	0.097
IIIb.	Low-energy photons (X-ray) – plutonium environments	0.022	0.142	0.011	0.134
IV.	High-energy photons	0.099	0.048	0.039	0.058
V.	Beta particles – general	N/A	N/A	0.091	0.036

a. N/A = not applicable.

A.4 BETA PARTICLE FIELD CHARACTERISTICS

The range of a beta particle of known energy can be rigorously calculated by integration of the $-dE/dx$ equation, which shows that the rate of energy loss is a complex function directly proportional to the number of atoms per cubic centimeter of absorber and to the Z of the absorber, and is exponentially related to the kinetic energy of the beta particle (Cross et al. 1982). However, a reasonably good approximation of the range R of a beta particle of energy E (in megavolts-electron) in any medium can be calculated in terms of density thickness (in milligrams per square centimeter) from the following empirical equation:

$$R = 412E^{(1.265-0.0954 \ln E)} \quad (\text{A-4})$$

which holds over the energy range 0.01 to 2.5 MeV. For energies above 2.5 MeV, the appropriate empirical relationship is:

$$R = 530E - 106 \quad (\text{A-5})$$

A somewhat less exact but still reasonable approximation for the range of a beta particle in units of grams per square centimeter is to divide the beta particle energy by 2: a 3-MeV particle would have a range of 1.5 g/cm², which corresponds to 36 ft, approximately the same value (within about 3%) obtained using either of the above equations.

Because of attenuation of beta radiation in air, the external dose associated with a fallout field is strongly dependent on distance. As one moves away from the beta field, more and more of the lower energy particles in the spectrum reach the end of their range and no longer contribute to the dose; 1 m of air is sufficient to attenuate all betas with energies below about 400 keV. And, as already noted, 36 ft of air is sufficient to absorb virtually all beta radiation associated with a fallout field, so beyond this distance there is zero beta dose. In contrast, as one moves closer to the fallout beta field, the external beta dose rate rises more rapidly than the concomitant gamma dose rate. Therefore, the beta-to-gamma dose rate ratio is a function of distance from the fallout field; at distances greater than 36 ft, the ratio is zero because there is no beta dose, as noted above. Calculations by Sondhaus and Bond (1955) on persons highly exposed to Marshall Islands weapons fallout contamination from the Bravo event indicate that, relative to the average whole-body gamma dose from a fallout field, the corresponding beta dose would range from about a factor of 2 at the head to about a factor of 10 at

ATTACHMENT A
DOSIMETRY TECHNOLOGY

Page 16 of 20

the bottom of the feet (bare) (standing on the contamination). At 1 m above the ground, the beta:gamma dose rate ratio was 3. This is consistent with the data obtained onboard a contaminated ship that showed a beta:gamma ratio of 10 at the deck level, 8 at knee level, and about 5 at film badge level (about 4 ft above the deck).

The above results appear inconsistent with the observations of Kulp and Dick (1960), who reported beta dose rates at 1 in. from a contaminated aircraft surface to be typically 10-fold greater than gamma dose rates at 1 ft from the surface. When a correction is made for the distance by using $1/d$ relationship for an infinite plane source to obtain the gamma dose rate at 1 in., the beta:gamma dose rate ratio falls to less than 1. However, the Kulp and Dick measurements involved vastly different geometries with opportunities for beta shielding and therefore might not be applicable to the type of exposures expected in the field at NTS. A more rigorous approach was taken by Broido and Teresi (1961) who evaluated the surface dose rate from beta radiation from a fallout field in relation to the gamma dose, and found the beta dose to be 13 times that of the gamma dose. Comparing the beta surface dose to the gamma dose at 1 m, Broido and Teresi observed a ratio of 40. In a study by Black (1962) in which actual measurements were made of doses to troops crawling through a contaminated fallout field, the beta:gamma dose ratio was approximately 7.

In these studies, the concern was the dose from contamination deposited on the skin, a situation rather different from the external exposure situation that could be encountered in the field at NTS and that would likely produce a higher beta:gamma dose ratio. Although numerous theoretical and empirical studies have been made of gamma radiation doses above fallout-contaminated ground, there have been few such studies of beta radiation doses. Review of operational monitoring logs from several Plumbbob detonations indicate, on the basis of survey meter readings, a beta:gamma dose rate ratio in the range of slightly greater than unity to a maximum of about 3, regardless of distances above the field (ranging to 3 ft), and for times ranging from 1 to 4 wk after the detonation. Beta:gamma dose rate ratios did not appear dependent on dose rate but, according to a study by Barnaby (1957), vary with time. At 1 m above the surface of contaminated ground, Barnaby found a beta:gamma dose ratio of 27 at 1.5 hr after detonation, dropping rapidly to a minimum of about 3 at 10 to 20 days after detonation, and then increasing again to about 30 at 400 days after detonation. This is not necessarily inconsistent with observations at NTS, which were mostly made from a few days to a few weeks after detonation.

Given the above discussion, for beta dose reconstruction in the absence of personnel monitoring data (i.e., exposures before 1967), dose reconstructors should assume that a reasonable estimate of beta dose favorable to claimants can be obtained by ratio with gamma dose. To this end, some provisional values are presented below (with the caveat that they are subject to revision as additional information is obtained). For beta doses incurred in a mixed beta-gamma radiation field a few days to a few weeks after detonation for which the gamma dose is known, a beta:gamma dose ratio of 5 would seem to be reasonable, while allowing a measure of overstatement to ensure favorability to claimants. In other words, the beta dose would be 5 times the measured gamma dose. If the mixed field exposure occurred less than 2 to 3 d after detonation, or more than 6 wk after detonation, a beta:gamma dose ratio of 10 is provisionally suggested. These provisional dose ratios take no credit for shielding or attenuation of beta particles by clothing (which could reduce them by a factor of 2 or more) and assume a 1-m distance from the fission product field with no overburden, leaching, vegetation, or other material or weathering action that would reduce the ratio, however likely this could be.

ATTACHMENT A
DOSIMETRY TECHNOLOGY
Page 17 of 20

Specific information on beta:gamma ratios for specific radionuclides, including the special case of immersion in iodine and noble gas clouds is presented in Attachment C.

A.5 NEUTRON FIELD CHARACTERISTICS

As indicated in Section 6.3.5.3, primary NTS operations with neutron exposure potential have been:

- Low-level waste
- Nuclear device assembly
- NRDS and BREN tower calibrations and operation (Operations BREN and HENRE)
- PLUTO reactor (nuclear-powered ramjet engine)
- Super Kukla reactor
- Nuclear explosive assembly using special nuclear material
- Down-hole well logging
- Neutron detection instrument calibration facilities

The neutron source spectra from these operations were either from fission of uranium and TRU nuclides or isotopic sources involving n,alpha reactions, such as $^{238}\text{PuBe}$ or $^{241}\text{AmBe}$. Moderation or scattering of the source neutrons results in a "softening" of the spectrum, with an increase in the fraction of low-energy neutrons present. This, in turn, results in (1) lower RBEs, quality factors, or radiation weighting factors, and (2) changes in the effective calibration factors for the energy-dependent dosimeters and instruments used for personal neutron dose assessment.

There is no indication that neutron spectral measurements were conducted at NTS for radiation protection purposes. However, IAEA has compiled extensive neutron spectral functions, instrument and dosimeter response functions, and dosimetric quantity response functions (Ing and Makra 1978; IAEA 1990, 2001). Because the source spectra for NTS operations are limited to those discussed above, adequate simulation can be obtained by selecting the proper neutron production mechanism and moderation and scatter conditions from the spectral catalogs that best simulate those for NTS operations.

Figures A-7 to A-9 show the effect of scattering and moderation on the neutron spectra. Figure A-10 and Table A-4 further illustrate the impact of spectral softening from scatter and moderation; that is, the fraction of $H_p(10,0)$ due to neutrons with energies less than the indicated value. For example, with the "hard," unmoderated $^{241}\text{AmBe}$ source spectrum, about 74% of the dose is due to neutrons above 2 MeV. The PuBe spectrum at 1 m is probably more characteristic of an unmoderated calibration source spectrum, with about 63% of the $H_p(10)$ due to neutrons above 2 MeV. In contrast, consider the much softer ^{252}Cf source spectrum in a 15-cm diameter D_2O sphere where 9% of the dose comes from neutrons below 0.1 MeV and only 31% of the dose comes from neutrons with energies greater than 2 MeV.

**ATTACHMENT A
DOSIMETRY TECHNOLOGY**
Page 18 of 20

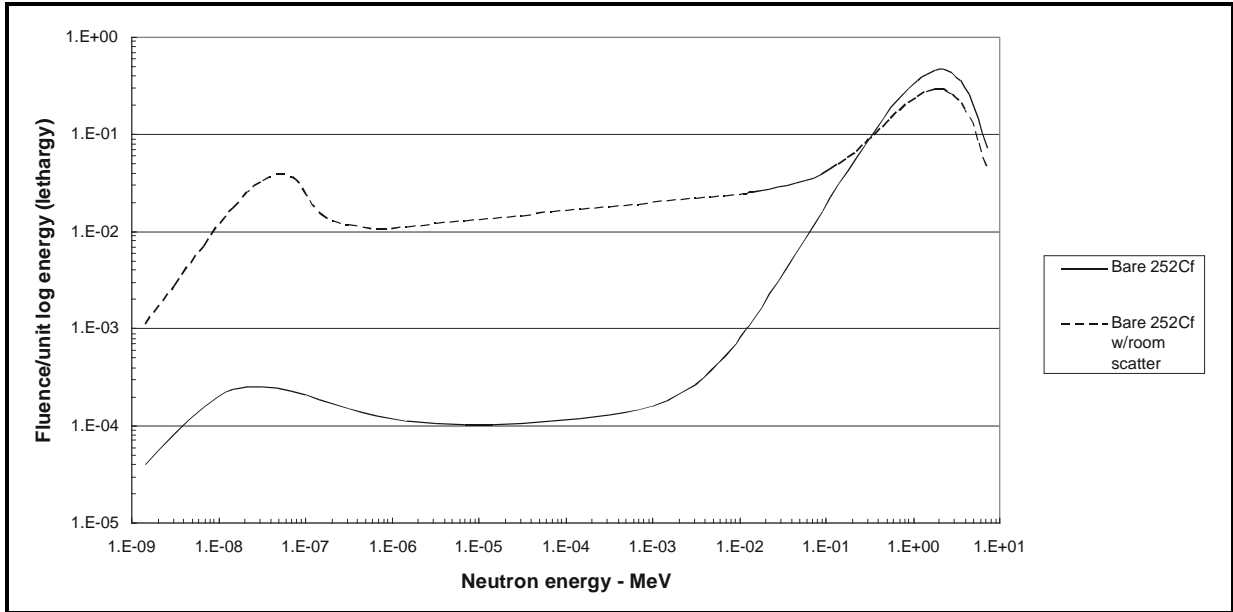

Figure A-7. Lethargy neutron spectra for ²⁵²Cf calibration source with and without room scatter (IAEA 2001).

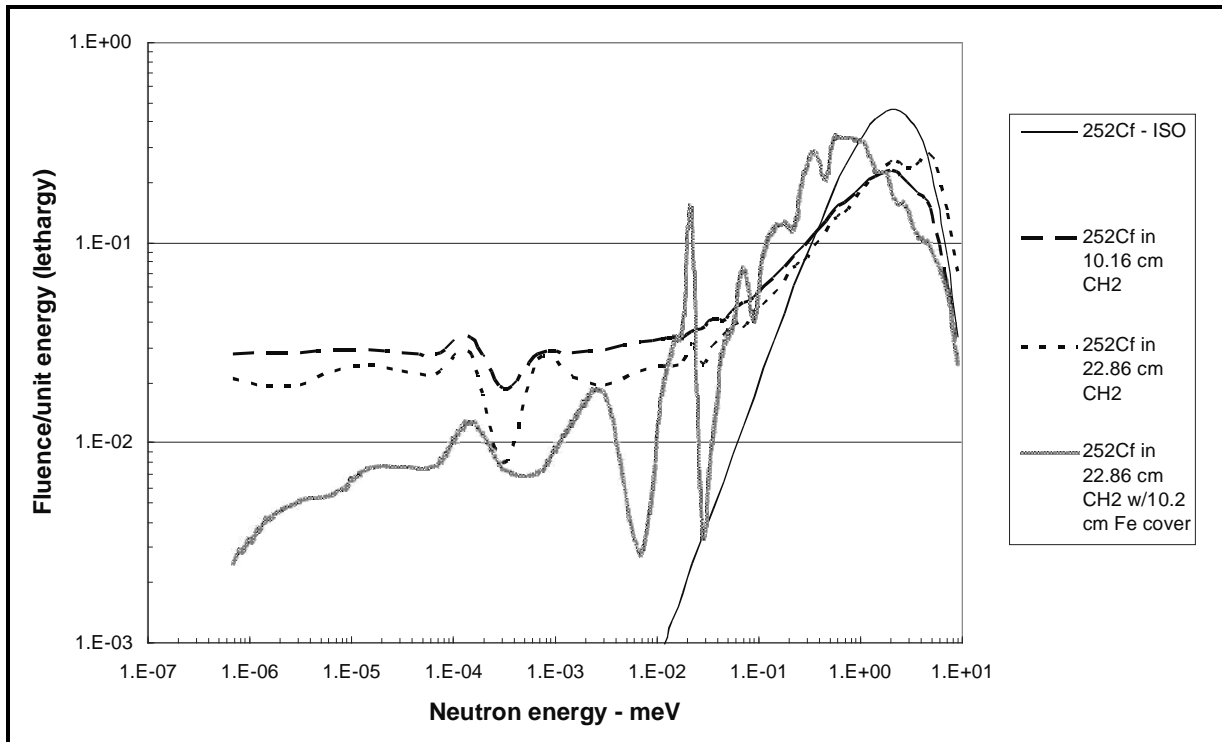

Figure A-8. Lethargy neutron spectra for ²⁵²Cf with various thickness moderators (IAEA 2001).

**ATTACHMENT A
DOSIMETRY TECHNOLOGY**
Page 19 of 20

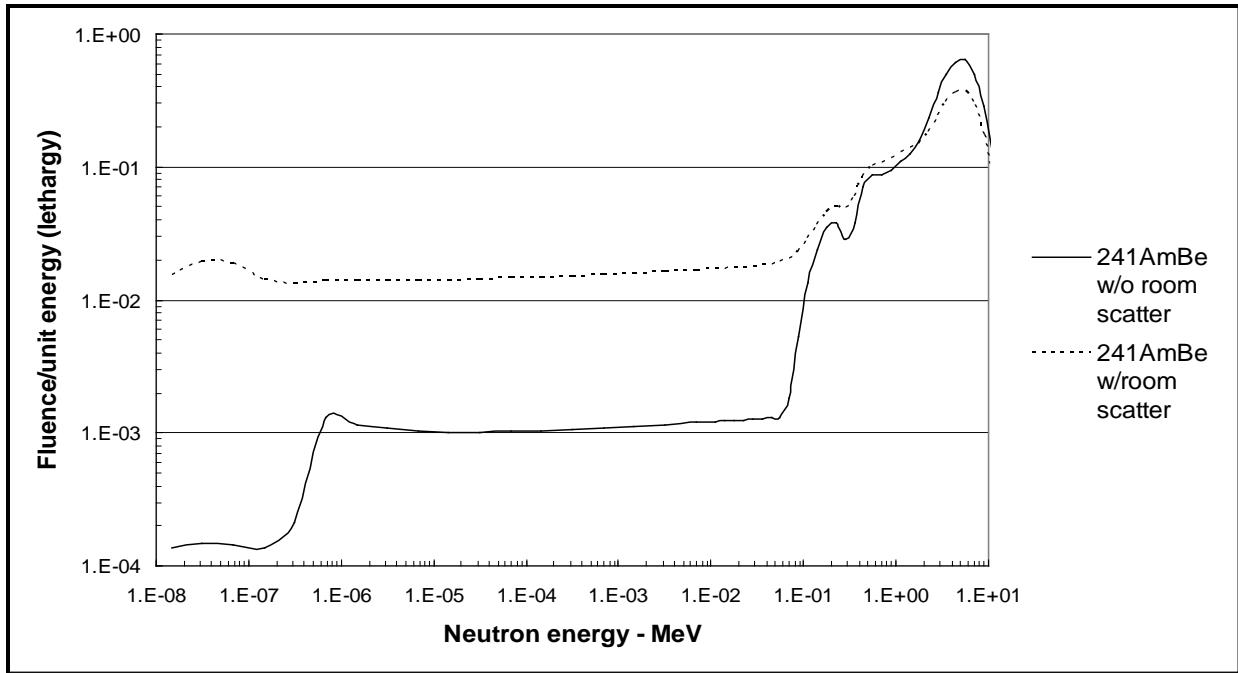

Figure A-9. Lethargy neutron spectra for an ²⁴¹AmBe calibration source with and without room scatter (IAEA 2001).

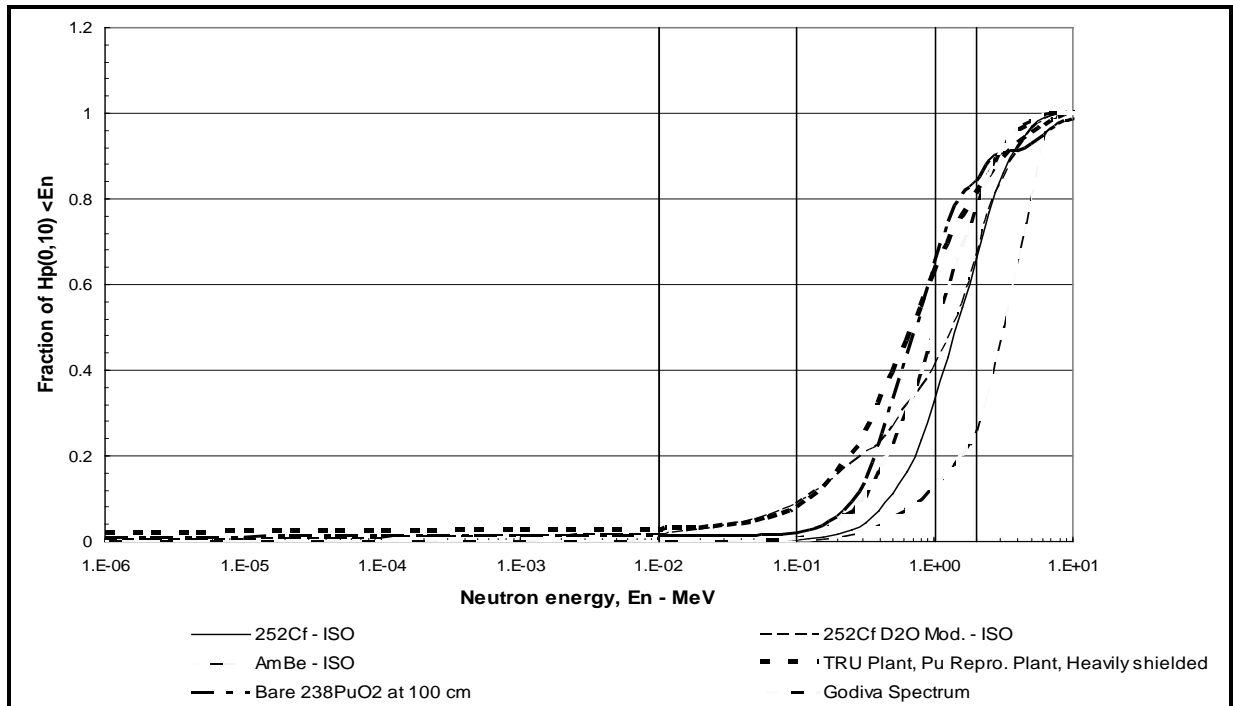

Figure A-10. Fraction of $H_p(10,0)$ due to neutrons with energies less than E_n .

ATTACHMENT A DOSIMETRY TECHNOLOGY

Page 20 of 20

Table A-4. Fraction of $H_p(10,0)$ for neutrons with energies less than E_n .

Energy E_n – MeV	Cf-252 ISO	Bare Cf-252 w/o shadow cone	Cf-252 D ₂ O Mod. - ISO	Cf-252 in D ₂ O w/o shadow cone	²⁴¹ AmBe ISO	AmBe w/o shadow cone	PuBe at 1m	TRU Plant, Pu Repro. Plant, heavily shielded	Bare ²³⁸ PuO ₂ at 100 cm	BREN HPRR ^a	HENRE linear accelerator ^b	Super Kukla reactor ^c	Godiva spectrum
1.00E-02	0.000	0.004	0.018	0.030	0.000	0.003	0.002	0.028	0.012	0.098	0.000	0.000	0.000
1.99E-02	0.000	0.005	0.027	0.039	0.000	0.003	0.002	0.032	0.013	0.103	0.000	0.000	0.000
5.01E-02	0.001	0.008	0.050	0.064	0.000	0.005	0.003	0.046	0.014	0.123	0.000	0.000	0.001
1.00E-01	0.003	0.017	0.089	0.106	0.001	0.010	0.005	0.080	0.021	0.150	0.000	0.100	0.008
1.99E-01	0.017	0.042	0.155	0.181	0.009	0.028	0.027	0.162	0.058	0.236	0.000	0.100	0.043
3.98E-01	0.072	0.114	0.228	0.283	0.037	0.070	0.066	0.321	0.225	0.3271	0.011	0.540	0.158
5.01E-01	0.110	0.158	0.269	0.328	0.053	0.099	0.088	0.392	0.331	0.374	0.011	0.540	0.226
7.94E-01	0.236	0.292	0.361	0.462	0.099	0.169	0.158	0.549	0.544	0.516	0.011	0.540	0.394
1.00E+00	0.325	0.382	0.407	0.516	0.127	0.212	0.242	0.625	0.646	0.565	0.022	0.794	0.492
1.25E+00	0.430	0.486	0.476	0.579	0.158	0.260	0.310	0.694	0.744	0.619	0.038	0.794	0.591
1.99E+00	0.662	0.708	0.668	0.775	0.262	0.376	0.373	0.814	0.842	0.772	0.074	0.875	0.781
3.98E+00	0.927	0.939	0.916	0.961	0.660	0.683	0.744	0.931	0.911	0.937	0.143	0.958	0.958
5.01E+00	0.968	0.969	0.963	0.969	0.813	0.806	0.871	0.956	0.930	0.967	0.168	1.000	0.983
7.94E+00	0.999	0.988	0.998	0.992	0.995	0.969	0.997	0.989	0.977	0.993	0.201	1.000	1.000
1.00E+01	1.000	0.993	1.000	0.994	1.000	0.991	1.000	0.999	0.987	0.996	0.217	1.000	1.000
1.58E+01	1.000	1.000	1.000	1.000	1.000	1.000	1.000	1.000	1.000	1.000	1.000	1.000	1.000

a. Source: Sims and Ragan, 1987.

b. Source: Burson 1970.

c. Source: Wimett 1965.

ATTACHMENT B
ENERGY GROUP ALLOCATION OF PHOTON EXPOSURE AND PERSONAL DOSE
EQUIVALENT BY NTS WORK AREA AND OPERATION

Page 1 of 2

TABLE OF CONTENTS

<u>SECTION</u>	<u>TITLE</u>	<u>PAGE</u>
B.1	Introduction	108
B.2	Work Area and Operation-Dependent Energy Group Photon Fractions.....	108

B.1 INTRODUCTION

Radionuclides with photon energies greater than 250 keV contribute a significant fraction of the penetrating ($E_{\gamma} \geq 30$ keV) photon exposures at NTS. If the fraction of photons with energies above 250 keV in a given area and operation is known, it is possible to make a more realistic, yet favorable to claimants, estimate of the fraction of exposure or personal dose equivalent in this higher energy group.

B.2 WORK AREA AND OPERATION-DEPENDENT ENERGY GROUP PHOTON FRACTIONS

ORAUT (2004, Table 2-2) presents an inventory of the radionuclides encountered at NTS by area and operation. This table is used as a basis for estimating the likely exposure and dose equivalent fraction in the energy groups 30-to-250-keV and >250-keV for these areas and operations. The photon (gamma and X-ray) decay properties for each nuclide has been obtained from the *WWW Table of Radioactive Isotopes* found on the Internet at URL: <http://ie.lbl.gov/toi/nucSearch.asp> (Firestone and Ekström 2002). The fraction of photons per decay have been determined in each of the three energy groups – <30-keV, 30-to-250-keV, and >250-keV – for each nuclide (Griffith 2005). A lower energy cutoff of 10 keV was used for the photons below 30 keV because these are highly unlikely to contribute a significant fraction to the external exposure.

Using the radionuclide inventory presented in Table 2-2 and assuming equal total photon contribution for each nuclide in any given area and operation, the photon fraction production has also been estimated for each area and operation. However, two adjustments have been made to these data. First, it is assumed that, because of the low penetrating power of photons less than 30 keV, 50% of these will be attenuated in surrounding material before they can contribute to individual exposures. Second, 20% of the photons with energies greater than 250 keV are assumed to be scattered, and result in an increased contribution to the 30-to-250-keV energy group, thus reducing the contribution from the higher energy photons accordingly. The results are listed in Table B-1.

ATTACHMENT B
ENERGY GROUP ALLOCATION OF PHOTON EXPOSURE AND PERSONAL DOSE
EQUIVALENT BY NTS WORK AREA AND OPERATION

Page 2 of 2

Table B-1. Work area and operation-dependent photon fractions.

Operation	Areas	Photon fraction			Adjusted photon fraction ^a		
		<30 keV	30-250 keV	>250 keV	<30 keV	30-250 keV	>250 keV
Drillback operations	1-10 and 18-20	0.06	0.36	0.58	0.03	0.50	0.47
Reentry and mineback operations	1, 12, 15, and 16	0.08	0.22	0.70	0.04	0.38	0.58
Routine tunnel operations	1, 12, 15, and 16	0.00	0.03	0.97	0.00	0.22	0.78
Decontamination facility	6	0.24	0.28	0.48	0.14	0.43	0.44
Treatability test facility	25	0.22	0.32	0.47	0.12	0.46	0.42
Atmospheric safety test areas	5 and 11	None indicated			None indicated		
Atmospheric weapons test areas	1-5, 7-11, and 18	0.18	0.31	0.51	0.10	0.45	0.45
Low-level waste site	3	0.47	0.25	0.28	0.31	0.40	0.29
Low-level waste site	5	0.34	0.31	0.36	0.20	0.45	0.34
Radiation instrument calibration	6 and 23	0.54	0.25	0.22	0.36	0.40	0.24
Radiograph operations	23	0.01	0.04	0.96	0.00	0.23	0.76
Well logging operations	1-10 and 18-20	0.49	0.23	0.29	0.32	0.38	0.30
Nuclear explosive/device assembly	6 and 27	0.73	0.27	0.00	0.57	0.43	0.00
Nuclear rocket development	25 and 26	0.04	0.29	0.67	0.02	0.43	0.55
Radioactive source storage	6 and 23	0.40	0.25	0.32	0.26	0.41	0.33
Radiochemistry and counting laboratories	6 and 23	0.16	0.25	0.59	0.09	0.40	0.51

a. Adjustment factors:

<30-keV contribution = 50 % of relative photon contribution to account for attenuation of low-energy photons.

30-250 KeV = photon contribution in that energy range + 20% of >250-keV contribution to account for scatter of high-energy photons.

>250 keV = 0.8 × high-energy photon contribution to account for loss due to scatter.

ATTACHMENT C
BETA-PHOTON RATIO ESTIMATES FOR NTS WORK AREAS AND OPERATIONS
Page 1 of 13

TABLE OF CONTENTS

<u>SECTION</u>	<u>TITLE</u>	<u>PAGE</u>
C.1	Introduction	110
C.2	Beta-Photon Ratios from Standing on a Contaminated Surface Following Nuclear Test or Reactor Operation	111
C.3	Beta-Photon Ratios from Immersion in a Contaminated Cloud Following Nuclear Test or Reactor Operation.....	113
C.4	Beta-Photon Ratios for Other Geometries.....	115
C.4.1	Photon Dose Constants	115
C.4.2	Beta Dose Rates.....	119
C.5	Summary of Beta-Photon Ratios.....	121

C.1 INTRODUCTION

As beta particles from sources outside the body enter tissue, the dose falls off rapidly with depth, and tissues and organs lying deeper than 10 mm in the body are unaffected. Thus, beta particles are appropriately ignored in considering external dose to most tissues and organs, which lie deeper than 10 mm; for them the appropriate quantities are gamma dose and neutron dose. The two exceptions are the skin, with its sensitive component (basal cells) at a depth of 0.07 mm, and the eye, with its sensitive component (lens) at a depth of 3 mm. The potential contribution from beta particles should be considered whenever the dose to skin or the lens of the eye is assessed.

As a result of a range of operations at NTS, a range of radionuclides can be found across the Site. An inventory of these nuclides is found in Table 2-2. However, nuclear testing and reactor operations, including nuclear rocket and ramjet tests, result in a much larger inventory in areas where these operations are conducted. The situation is made much more complex by the time dependence of the radionuclide inventory following detonation or reactor operation. This time dependence results in a variation in the radiological properties of the inventory that also varies with time. An extensive set of publications by Harry Hicks at LLNL (Hicks 1981a to 1981i, 1982, 1984) has produced a vast set of data covering 177 fission and activation products for periods from 1 hr to 50 yr following detonation or reactor operation. Surface roughness effects are simulated by using values of (mR/h)/(μCi/m²) for a relaxation length of 0.16 g/cm² (Beck 1980). According to Beck, the concentration of fallout varies exponentially with soil depth, Z, according to the relation $C = C_0 e^{-\alpha Z}$, and he defines relaxation length as $1/\alpha$. The Hicks publications represent a very detailed source term for beta-photon ratio calculations.

ATTACHMENT C
BETA-PHOTON RATIO ESTIMATES FOR NTS WORK AREAS AND OPERATIONS
Page 2 of 13

C.2 BETA-PHOTON RATIOS FROM STANDING ON A CONTAMINATED SURFACE FOLLOWING NUCLEAR TEST OR REACTOR OPERATION

The fundamentals of the method for estimating external dose to the skin and eye from standing on contaminated ground are summarized as follows:

1. Beta dose to the skin or lens of the eye from external sources is accrued with the gamma dose from radioactive fallout, contamination, or neutron-induced radionuclides. As a result, the beta dose is proportional to the gamma dose, and its relative magnitude can be expressed by a beta-to-gamma dose ratio.
2. The beta-to-gamma dose ratio depends on radionuclide decay and distribution and on geometric relationships between the exposed individual and the radiation source. Gamma and beta energy spectra are interdependent functions of time. Consequently, the beta-to-gamma dose ratio depends on time since detonation.
3. Because of the attenuation characteristics of electrons in matter, beta dose assessments depend more critically than gamma dose assessments on geometry and the shielding material between the radioactive source and the exposed individual. Consequently, the nature of specific job- or task-related activities and their associated protective measures entails special attention and evaluation in determining a beta dose component.
4. Beta doses to skin are evaluated at the anatomic location where a skin cancer has been diagnosed. The depth for evaluation is 0.07 mm, the conventional depth of the basal-cell layer of the skin, which is assumed to be the tissue at risk for skin cancer. Beta doses to the lens of the eye are assessed at a depth of 3 mm below the front surface of the eye, where the tissue at risk for posterior subcapsular cataract development is assumed to be.
5. A beta energy greater than 0.07 MeV is required to penetrate the dead epidermal layer, so beta particles with energies less than that are not included in dose assessments.
6. Skin and eye doses are assessed as the sum of the applicable "high-sided" beta and "high-sided" gamma doses (neutron doses presumably are included if they are significant).
7. Fallout deposited on a surface is considered to be a semi-infinite plane isotropic source, and decontamination activities are considered in evaluating beta doses. Assessments of skin doses are simplified by ignoring attenuation of electrons by large fallout particles that contain volume-distributed activity, particle and photon scattering due to surface roughness, particle and photon attenuation due to penetration into a radioactive surface, and radioactive-source depletion due to weathering, chemical dissociation, or environmental transport (concentration or dispersion). Those simplifications have the effect of making the calculated doses overestimates.

Barss (2000) provides methods and tables useful for assessing beta dose. They include separate tables of beta-to-gamma dose ratios from exposure to fission products on the ground as a function of time since detonation for NTS and Pacific tests (in the Pacific, one table applies to Operation CASTLE, Test BRAVO fallout, and a second table applies to all other tests). A separate table of beta-to-gamma dose ratios is provided for activation products in soil. The beta-to-gamma dose ratios are calculated from published beta-particle and gamma-ray spectra. For illustration, the beta-to-gamma

ATTACHMENT C
BETA-PHOTON RATIO ESTIMATES FOR NTS WORK AREAS AND OPERATIONS
Page 3 of 13

dose ratios from the table for Pacific tests are plotted in Figure C-1. The figure illustrates the substantial variation of beta-to-gamma dose ratios with time after detonation and height above ground. The beta-to-gamma dose ratios for the lens of the eye are much smaller because the greater depth of the sensitive tissue (3 mm for lens vs. 0.07 mm for skin) leads to much more attenuation.

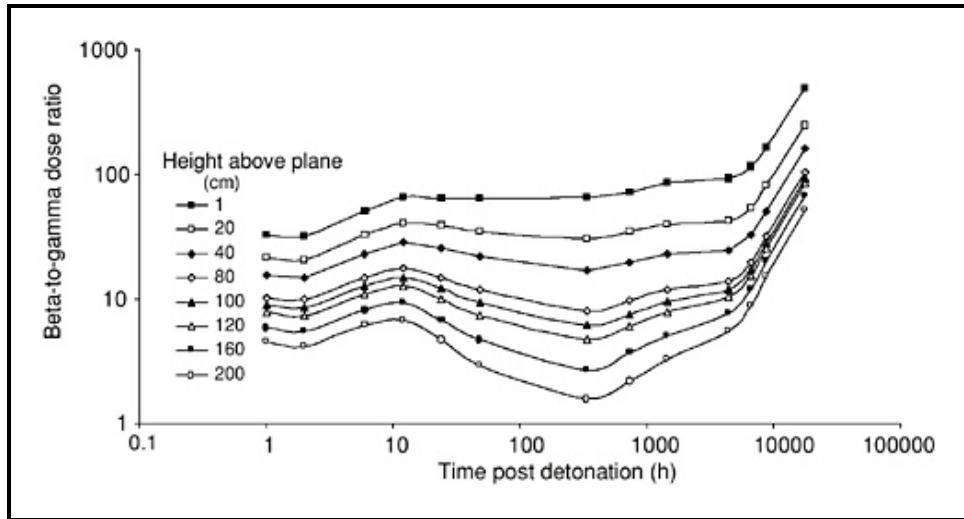

Figure C-1. Beta-to-gamma dose ratios for contaminated surfaces used at Pacific tests (Barss 2000).

Activation products are distributed with depth in soil because they originate primarily by interactions with neutrons that penetrate into the soil rather than in deposition from the atmosphere. Thus, beta-to-gamma dose ratios of activation products are small because most of the activation products are deeper in the soil than the range of the emitted beta particles.

Extensive calculations of beta and photon dose conversion factors for skin from (1) surface contamination and (2) air immersion are now available for 825 radionuclides (Eckerman et al. 1999), based on the work of Kocher and Eckerman (1981). The geometry involves the use of a reference adult phantom placed (1) on a contaminated ground plane and (2) immersed in a semi-infinite cloud of contaminated air. The CD, FGR_13, does not provide separate conversion factors for beta and photons. However, they are available for skin only from Eckerman (2006b).

The Hicks report presents the surface contamination following each event in three tables of radionuclide concentration in terms of $\mu\text{Ci}/\text{m}^2$: zero to 21 hr after detonation (177 radionuclides); zero to 300 d after detonation (128 radionuclides); and zero to 50 yr after detonation (37 radionuclides). These data have been used together with the beta and photon dose conversion factors (Eckerman 2006b) to calculate radionuclide inventory-weighted beta-photon ratios. Examples of the resulting calculations for selected atmospheric tests are shown in Figure C-2. These are quite consistent with the values shown in Figure C-1 for a height of about 120 cm. Both figures show a significant increase at later times, 100–200 d. The maximum time for Figure C-1 is 2 yr, so the decrease after that in Figure C-2 out to 50 yr is not shown. Figure C-3 shows the results of similar calculations for the effluents from nuclear rocket and ramjet tests. Tabulated beta-photon ratios for the fallout from 35 tests are listed in Table C-1. These values can be modified with appropriate factors for shielding and distance (Barss and Weitz 2006).

ATTACHMENT C
BETA-PHOTON RATIO ESTIMATES FOR NTS WORK AREAS AND OPERATIONS
Page 4 of 13

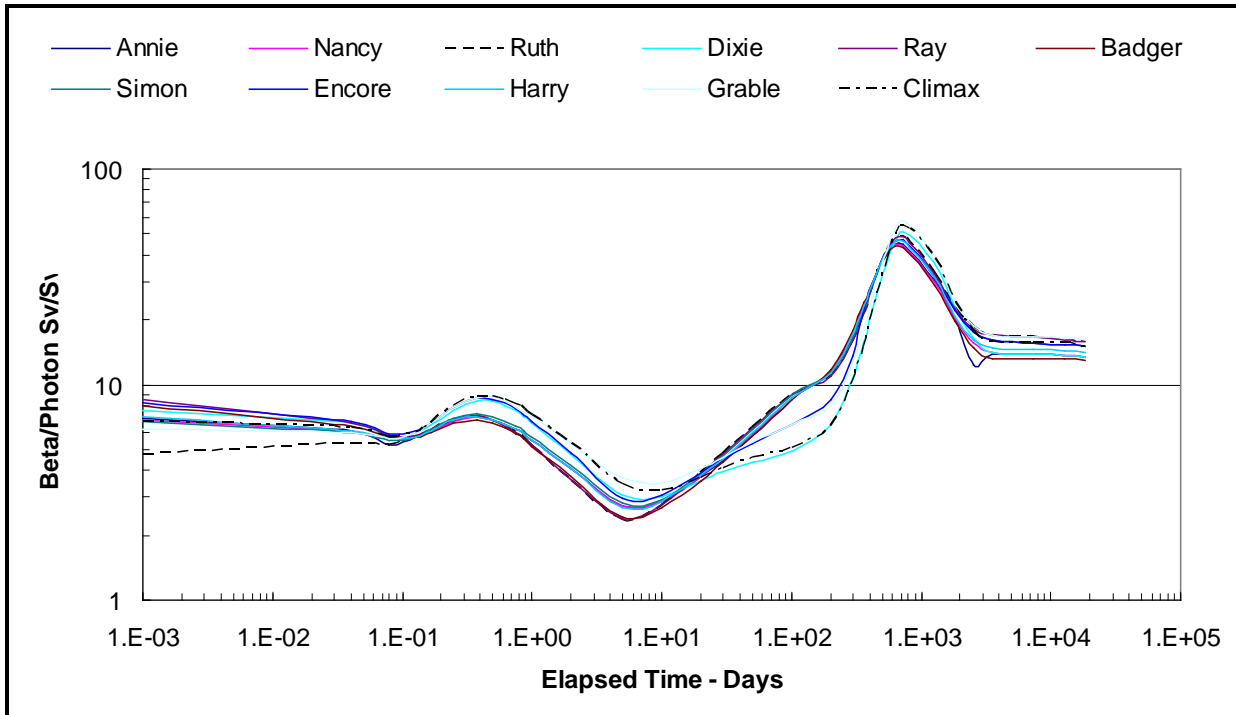

Figure C-2. Calculated beta-photon ratios (Sv/Sv) for skin for 11 atmospheric tests from Operation Upshot-Knothole.

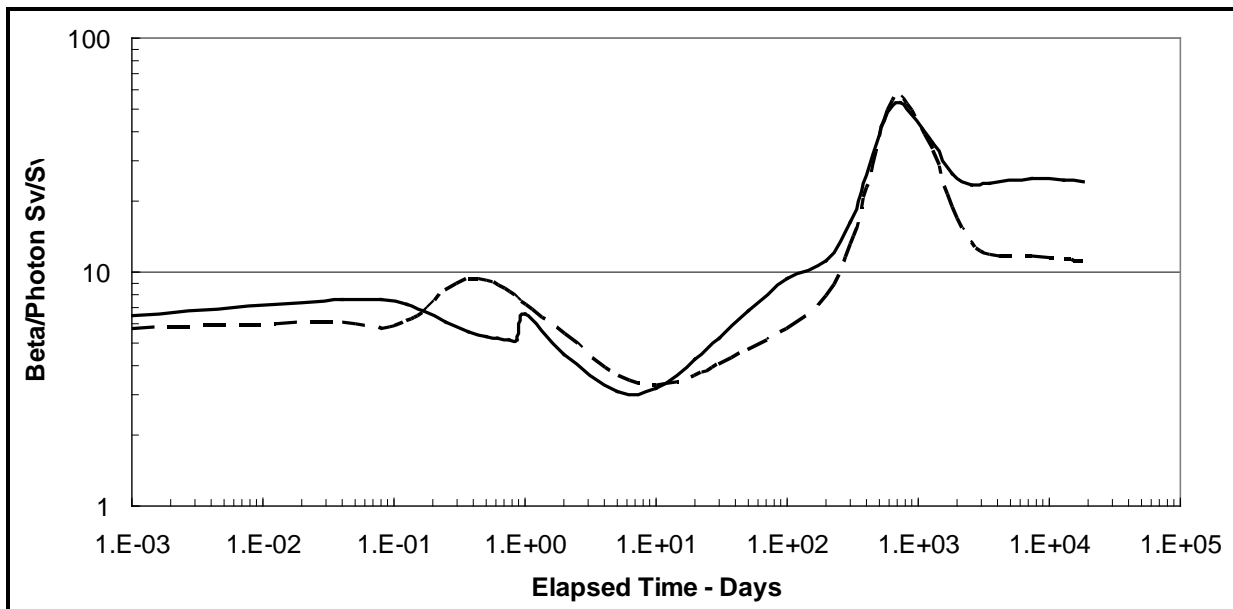

Figure C-3. Calculated beta-photon ratios (Sv/Sv) for skin for nuclear rockets and ramjet test effluents.

**ATTACHMENT C
BETA-PHOTON RATIO ESTIMATES FOR NTS WORK AREAS AND OPERATIONS**

Table C-1. Calculated beta-photon ratios for mixed fission and activation products from Sedan and tests from Operations Ranger, Buster-Jangle, Tumbler-Snapper, and Upshot-Knothole—contaminated surfaces.

Event	Year	Beta-photon ratio															Overall average ^a	1-day reentry ^a	Onsite during year ^a
		Hours				Days				Years									
		0.	1.0	2.	12.	1.0	10.	50.	200.	1.0	2.0	5.0	10.	20.	50.				
Ranger Able	1951	10.4	7.5	6.2	8.1	6.0	2.8	5.0	7.2	15.6	47.0	18.0	13.2	14.9	15.6	12.7	8.0	24.3	
Ranger Baker		9.6	7.1	5.9	7.4	5.7	2.7	4.3	7.8	19.2	43.9	17.0	8.8	9.6	10.1	11.4	7.4	21.6	
Ranger Easy		12.5	8.3	6.4	6.8	4.8	2.3	4.3	7.8	19.2	43.9	17.0	8.8	9.6	10.0	11.6	7.1	21.6	
Ranger Baker 2		9.3	7.0	5.9	7.5	5.7	2.7	4.3	7.8	19.2	43.9	17.0	8.8	9.6	10.1	11.3	7.4	21.6	
Ranger Fox		8.2	6.7	5.9	8.3	6.5	3.0	4.8	7.3	17.0	45.9	18.0	11.9	13.4	14.0	12.2	8.0	23.5	
Buster Baker	1951	5.8	5.8	5.4	7.8	6.6	3.0	3.7	7.3	18.5	41.5	16.1	6.9	7.3	7.7	10.2	7.4	18.9	
Buster Charlie		8.2	6.6	5.9	8.4	6.6	3.0	4.5	6.4	14.8	45.0	17.7	12.3	13.9	14.5	12.0	8.1	21.9	
Buster Dog		8.8	6.9	5.9	8.1	6.3	2.8	4.5	6.5	15.4	44.4	17.5	11.4	12.9	13.4	11.8	7.9	21.9	
Buster Easy		7.0	6.3	5.7	8.6	6.9	3.1	4.4	6.5	15.2	44.5	17.6	11.6	13.1	13.7	11.7	8.2	21.5	
Jangle Sugar	1951	7.2	6.1	5.6	6.6	5.2	2.8	6.5	12.3	22.8	45.7	21.9	16.9	16.5	15.8	13.7	6.5	32.9	
Jangle Uncle		7.2	6.1	5.6	6.6	5.2	2.8	6.5	12.3	22.8	45.8	21.9	16.9	16.5	15.8	13.7	6.5	32.9	
Tumbler-Snapper Able	1952	11.6	7.9	6.4	7.8	5.6	2.7	5.5	8.3	18.7	59.0	24.4	16.4	16.4	15.8	14.8	7.8	26.9	
Tumbler-Snapper Baker		11.5	7.8	6.3	7.9	5.7	2.7	5.5	8.3	18.7	59.0	24.4	16.4	16.3	15.8	14.7	7.9	26.9	
Tum.-Snapper Charlie		9.0	6.9	6.0	8.2	6.3	2.9	5.2	8.6	20.3	55.4	23.3	14.1	13.9	13.5	13.8	8.0	25.8	
Tum.-Snapper Dog		7.6	6.4	5.7	8.4	6.7	3.1	5.2	8.6	20.3	55.4	23.3	14.1	13.9	13.5	13.7	8.1	25.8	
Tum.-Snapper Easy		6.0	5.8	5.4	7.0	5.8	3.0	5.9	11.6	24.1	47.3	21.8	14.4	14.0	13.4	13.3	6.8	30.0	
Tum.-Snapper Fox		7.1	6.1	5.6	6.8	5.4	2.9	5.9	11.6	24.1	47.5	21.9	14.5	14.1	13.5	13.4	6.7	30.0	
Tum.-Snapper George		7.0	6.2	5.6	6.8	5.4	2.9	5.9	11.6	24.1	47.5	21.9	14.5	14.1	13.5	13.4	6.7	30.0	
Tum.-Snapper How		5.6	5.7	5.4	7.1	5.9	3.1	5.9	11.6	24.0	47.3	21.8	14.5	14.1	13.5	13.3	6.8	30.0	
Upshot-Knot. Annie	1953	6.9	6.1	5.3	6.9	5.5	2.9	5.8	11.5	23.5	45.1	20.4	13.8	13.8	13.5	12.9	6.7	29.6	
Upshot-Knot. Nancy		6.9	6.0	5.5	6.9	5.5	2.9	5.9	11.6	23.8	44.1	20.5	14.0	13.9	13.5	12.9	6.7	30.0	
Upshot-Knot. Ruth		4.7	5.3	5.3	6.8	5.1	2.7	6.3	11.0	21.1	49.0	22.6	16.9	16.5	15.8	13.5	6.5	31.4	
Upshot-Knot. Dixie		7.6	6.6	5.6	8.4	6.6	3.0	4.4	6.6	15.7	50.8	23.0	14.2	13.9	13.5	12.9	8.1	21.5	
Upshot-Knot. Ray		8.5	6.6	5.8	6.8	5.2	2.8	6.3	11.0	21.6	48.9	22.5	16.9	16.5	15.8	13.9	6.8	31.4	
Upshot-Knot. Badger		8.0	6.4	5.7	6.6	5.2	2.7	5.8	11.7	24.2	43.0	19.8	13.2	13.1	12.9	12.7	6.6	29.6	
Upshot-Knot. Simon		6.7	6.0	5.6	7.1	5.7	2.9	6.2	11.3	22.4	46.9	22.1	16.1	15.7	15.1	13.6	6.9	31.2	
Upshot-Knot. Encore		8.3	6.7	5.9	8.6	6.8	3.1	5.4	8.5	22.4	46.9	22.1	16.1	15.7	15.1	13.7	8.3	26.6	
Upshot-Knot. Harry		7.1	6.1	5.6	6.9	5.5	2.9	6.0	11.4	23.3	46.4	20.8	14.7	14.5	14.0	13.2	6.8	30.4	
Upshot-Knot. Grable		6.2	6.0	5.6	8.7	7.0	3.5	5.5	8.0	18.0	57.7	25.1	17.1	16.7	16.0	14.4	8.2	26.8	
Upshot-Knot. Climax		6.7	6.3	5.7	8.9	7.2	3.3	4.6	6.4	14.9	54.6	24.1	15.8	15.7	15.1	13.5	8.4	22.3	
Sedan	1962	5.3	5.4	4.8	4.0	3.3	2.5	2.6	2.9	4.6	11.6	10.1	5.3	6.5	7.8	5.5	4.2	12.3	
Maximum		12.5	8.3	6.4	8.9	7.2	3.5	6.5	12.3	24.2	59.0	25.1	17.1	16.7	16.0	16.0	8.8	32.9	

a. The average values may be used when a reasonable approach is required or when the employee is not directly identified with an event.

ATTACHMENT C
BETA-PHOTON RATIO ESTIMATES FOR NTS WORK AREAS AND OPERATIONS
Page 6 of 13

C.3 BETA-PHOTON RATIOS FROM IMMERSION IN A CONTAMINATED CLOUD FOLLOWING NUCLEAR TEST OR REACTOR OPERATION

The special situation exists in which a worker might have been exposed to photons and beta particles by immersion in a contaminated cloud. This situation is known to have occurred due to release of radioiodines and noble gases during post-test drilling operations. Because of the exposure geometry, beta gamma ratios under such circumstances are likely to have been different than those addressed above.

The beta dose rate factors due to immersion in semi-infinite contaminated clouds of radionuclides in air have been estimated by Kocher and Eckerman (1981) and implemented in Eckerman et al. (1999). As for the surface contamination geometry, the separate unpublished beta and photon dose conversion factors for each radionuclide are available (Eckerman 2006b). Table C-2 lists the time-dependent beta-photon ratios for the radionuclide inventories provided in the Hicks reports, but in a semi-infinite cloud. The ratios are lower than those from a contaminated surface because the betas are absorbed by the cloud to a greater extent than the photons. The exposure of post-test drilling crews to clouds of fission product noble gases (krypton and xenon), and halogens (bromine and iodine) has been noted. A separate calculation has been made for cloud immersion beta-photon ratios following 11 tests in the Ranger and Buster-Jangle test series using only the isotopes of those elements. There is very little variation in the results from one test to another, because there is little variation and fractionation for those nuclides. The maximum ratios are shown in Figure C-4. The ratios are consistently below 1.0 until the 10.7-yr ⁸⁵Kr begins to dominate after about 100 d.

C.4 BETA-PHOTON RATIOS FOR OTHER GEOMETRIES

In addition to activation and fission products from nuclear tests and reactor operation, radionuclides have been used or handled in various areas throughout NTS. An inventory of these radionuclides is presented in ORAUT (2004, Table 2-2). For the most part, the geometries for exposure to these radionuclides is difficult to specify with any accuracy. The beta-photon ratios are also difficult to specify with any certainty. In many cases, such as the use of encapsulated radioactive sources, although the radionuclides involved might have an inherently high beta-photon ratio, the encapsulation is likely to absorb the associated beta particles. For the purpose of estimating beta-photon ratios for a geometry other than extended contaminated surfaces or cloud immersion, it is necessary to select an arbitrary, but realistic, geometry as a basis for the ratio estimates. The calculations presented in this attachment are based on a distance of 1 m for a point source.

C.4.1 Photon Dose Constants

The values of the specific gamma ray dose constant, Γ , in mSv/hr/MBq at 1 m were established for each radionuclide in the inventory listed in Table 2-2. The values of Γ for several of those nuclides are presented in Table 6.2.2 of the *Handbook of Health Physics and Radiological Health* (Shleien, Slaback, and Birky 1998). Those values are based on the work of Unger and Trubey (1981), and appear in Table C-3.

For Table 2-2 nuclides not presented in the *Handbook of Health Physics and Radiological Health*, Table 6.2.2, the values of Γ were calculated using the procedure of Unger and Trubey, as follows:

ATTACHMENT C
BETA-PHOTON RATIO ESTIMATES FOR NTS WORK AREAS AND OPERATIONS

Table C-2. Calculated beta-photon ratios for mixed fission and activation products from Operations Ranger, Buster-Jangle, Tumbler-Snapper, and Upshot-Knothole tests—immersion in a contaminated semi-infinite cloud.

Event	Year	Beta-photon ratio															Overall average ^a	1-day reentry ^a	Onsite during year ^a
		Hours				Days				Years									
		0.	1.0	2.	12.	1.0	10.	50.	200.	1.0	2.0	5.0	10.	20.	50.				
Ranger Able	1951	1.4	1.0	0.8	1.2	1.0	0.5	0.7	1.0	2.2	6.6	2.6	2.0	2.3	2.4	1.8	1.2	3.4	
Ranger Baker		1.3	0.9	0.8	1.1	0.9	0.5	0.6	1.1	2.7	6.2	2.4	1.3	1.5	1.6	1.6	1.1	3.0	
Ranger Easy		1.7	1.1	0.8	1.1	0.9	0.5	0.6	1.1	2.7	6.2	2.4	1.3	1.5	1.6	1.7	1.1	3.0	
Ranger Baker 2		1.2	0.9	0.8	1.1	0.9	0.5	0.6	1.1	2.7	6.2	2.4	1.3	1.5	1.6	1.6	1.1	3.0	
Ranger Fox		1.1	0.9	0.8	1.2	1.0	0.5	0.7	1.0	2.4	6.5	2.6	1.8	2.0	2.1	1.8	1.2	3.4	
Buster Baker	1951	0.8	0.8	0.7	1.0	0.9	0.5	0.5	1.0	2.6	5.9	2.3	1.0	1.2	1.2	1.5	1.0	2.6	
Buster Charlie		1.1	0.9	0.8	1.2	1.0	0.5	0.6	0.9	2.1	6.4	2.5	1.8	2.1	2.2	1.7	1.2	2.9	
Buster Dog		0.8	0.8	0.7	1.0	1.0	0.5	0.6	0.9	2.2	6.3	2.5	1.7	2.0	2.1	1.7	1.0	2.9	
Buster Easy		0.9	0.8	0.7	1.2	1.0	0.5	0.6	0.9	2.1	6.3	2.5	1.7	2.0	2.1	1.7	1.1	2.9	
Jangle Sugar	1951	0.9	0.8	0.7	0.9	0.8	0.5	0.8	1.6	3.2	6.6	3.2	2.5	2.5	2.4	2.0	0.9	4.1	
Jangle Uncle		0.9	0.8	0.7	0.9	0.8	0.5	0.8	1.6	3.2	6.6	3.2	2.6	2.5	2.4	2.0	0.9	4.1	
Tumbler-Snapper Able	1952	1.6	1.0	0.8	1.2	1.0	0.6	0.8	1.1	2.6	8.4	3.6	2.5	2.5	2.4	2.2	1.2	3.9	
Tumbler-Snapper Baker		1.6	1.0	0.8	1.2	1.0	0.6	0.8	1.1	2.6	8.4	3.6	2.5	2.5	2.4	2.2	1.2	3.9	
Tum.-Snapper Charlie		1.2	0.9	0.8	1.2	1.0	0.5	0.7	1.2	2.8	7.9	3.4	2.1	2.1	2.1	2.0	1.2	3.5	
Tum.-Snapper Dog		1.0	0.8	0.7	1.2	1.0	0.5	0.7	1.2	2.8	7.9	3.4	2.1	2.1	2.1	2.0	1.1	3.5	
Tum.-Snapper Easy		0.8	0.8	0.7	1.0	0.8	0.5	0.8	1.6	3.4	6.8	3.2	2.2	2.2	2.1	1.9	1.0	4.1	
Tum.-Snapper Fox		0.9	0.8	0.7	1.0	0.8	0.5	0.8	1.6	3.4	6.8	3.2	2.2	2.2	2.1	1.9	1.0	4.1	
Tum.-Snapper George		0.9	0.8	0.7	1.0	0.8	0.5	0.8	1.6	3.4	6.8	3.2	2.2	2.2	2.1	1.9	1.0	4.1	
Tum.-Snapper How		0.7	0.7	0.7	1.0	0.8	0.5	0.8	1.6	3.4	6.8	3.2	2.2	2.2	2.1	1.9	1.0	4.1	
Upshot-Knot. Annie	1953	0.9	0.8	0.7	1.0	0.8	0.5	0.8	1.6	3.3	6.5	3.0	2.1	2.1	2.1	1.9	1.0	4.1	
Upshot-Knot. Nancy		0.9	0.8	0.7	1.0	0.8	0.5	0.8	1.6	3.3	6.1	2.8	2.0	2.1	2.1	1.8	1.0	4.1	
Upshot-Knot. Ruth		0.7	0.7	0.7	1.0	0.8	0.5	0.8	1.5	3.6	7.6	3.6	2.8	2.8	2.6	2.1	1.0	4.0	
Upshot-Knot. Dixie		1.0	0.9	0.7	1.2	1.0	0.5	0.6	0.9	2.2	7.1	3.2	2.1	2.1	2.1	1.8	1.1	2.9	
Upshot-Knot. Ray		1.1	0.9	0.8	1.0	0.8	0.5	0.8	1.5	3.0	7.0	3.3	2.6	2.5	2.4	2.0	1.0	4.0	
Upshot-Knot. Badger		1.0	0.8	0.7	1.0	0.8	0.5	0.8	1.6	3.4	6.0	2.7	1.9	2.0	2.0	1.8	1.0	4.1	
Upshot-Knot. Simon		0.9	0.8	0.7	1.0	0.8	0.5	0.8	1.5	3.1	6.5	3.1	2.4	2.4	2.3	1.9	1.0	4.0	
Upshot-Knot. Encore		1.1	0.9	0.8	1.2	1.0	0.5	0.7	1.2	3.1	6.5	3.1	2.4	2.4	2.3	1.9	1.2	3.5	
Upshot-Knot. Harry		0.9	0.8	0.7	1.0	0.8	0.5	0.8	1.6	3.3	6.7	3.0	2.2	2.2	2.1	1.9	1.0	4.1	
Upshot-Knot. Grable		0.8	0.8	0.7	1.2	1.0	0.5	0.8	1.1	2.5	8.3	3.7	2.6	2.5	2.4	2.1	1.1	3.9	
Upshot-Knot. Climax		0.9	0.8	0.7	1.2	1.0	0.5	0.6	0.9	2.1	7.8	3.5	2.4	2.4	2.3	1.9	1.1	2.9	
Maximum		1.7	1.1	0.8	1.2	1.0	0.6	0.8	1.6	3.6	8.4	3.7	2.8	2.8	2.6	2.3	1.2	4.1	

a. The average values may be used when a reasonable approach is required or when the employee is not directly identified with an event.

ATTACHMENT C
BETA-PHOTON RATIO ESTIMATES FOR NTS WORK AREAS AND OPERATIONS
Page 8 of 13

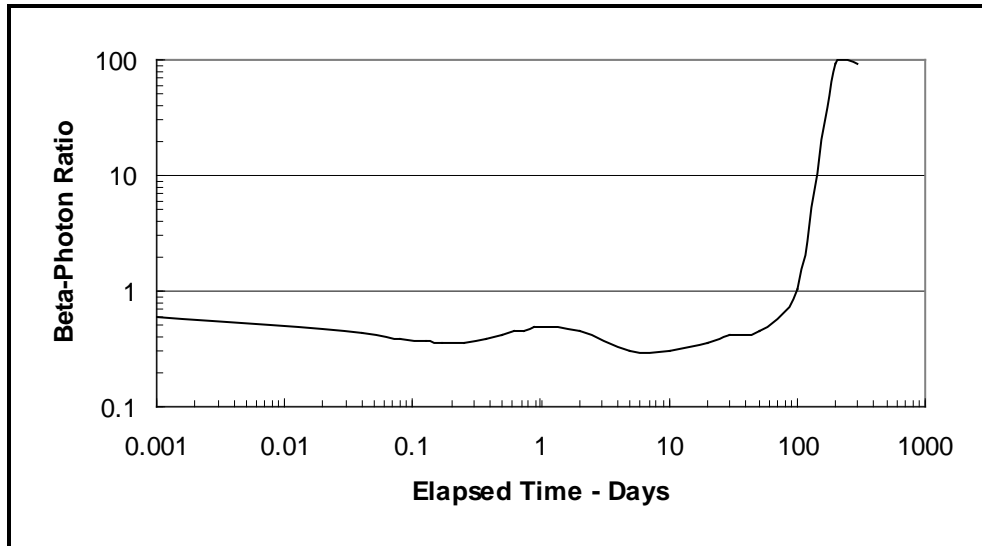

Figure C-4. Calculated beta-photon ratios for immersion in a contaminated semi-infinite cloud—maximum of values from 11 atmospheric test radionuclide inventories.

Table C-3. Photon dose constants, beta dose rates, and beta-photon ratios for NTS radionuclides.

Radionuclide of concern	Photon dose constant, Γ^a mSv/hr per MBq	Beta dose rate at 1 m ^b D(0.07) mGy/hr per MBq	Beta/photon Gy/Sv
Ac-227	2.36E-06	0.0E+00	0.0E+00
Am-241	8.48E-05	0.0E+00	0.0E+00
Am-243	8.46E-05	0.0E+00	0.0E+00
AmBe-241	8.48E-05	N/A	N/A
Ba-133	1.23E-04	0.0E+00	0.0E+00
Ba-140	4.45E-05	1.2E-02	2.7E+02
Cd-109	4.98E-05	0.0E+00	0.0E+00
Ce-139	5.55E-05	0.0E+00	0.0E+00
Ce-141	1.98E-05	3.1E-04	1.5E+01
Ce-143	6.89E-05	3.9E-03	5.6E+01
Ce-144	6.30E-06	D(0.07) = 9.2E-03 D(10) = 1.5E-05	1.5E+03 2.4E+00
Cf-252	1.13E-05	0.0E+00	0.0E+00
Cm-244	1.74E-05	0.0E+00	0.0E+00
Co-57	4.09E-05	4.0E-03	9.8E+01
Co-60	3.70E-04	0.0E+00	0.0E+00
Cs-134	2.70E-04	1.4E-03	5.2E+00
Cs-137 ^c	1.03E-04	2.1E-03	2.1E+01
Eu-152	2.01E-04	3.0E-03	1.5E+01
Eu-154	2.04E-04	2.8E-03	1.4E+01
Eu-155	1.80E-05	0.0E+00	0.0E+00
Fe-59	1.79E-04	5.0E-05	2.8E-01
H-3	0.00E+00	0.0E+00	N/A
Hg-203	6.84E-05	0.0E+00	0.0E+00
I-131	7.65E-05	1.2E-03	1.6E+01

ATTACHMENT C
BETA-PHOTON RATIO ESTIMATES FOR NTS WORK AREAS AND OPERATIONS

Page 9 of 13

Radionuclide of concern	Photon dose constant, Γ^a mSv/hr per MBq	Beta dose rate at 1 m ^b D(0.07) mGy/hr per MBq	Beta/photon Gy/Sv
I-132	3.86E-04	6.9E-03	1.8E+01
I-133	1.11E-04	6.8E-03	6.1E+01
I-135	2.33E-04	5.7E-03	2.4E+01
Ir-192	1.60E-04	1.2E-03	7.5E+00
Kr-85	4.23E-07	3.5E-03	8.3E+03
Lu-174	3.06E-05	5.6E-03	1.8E+02
Mn-54	1.38E-04	2.8E-03	2.0E+01
Mo-99	3.05E-05	6.3E-03	2.1E+02
Na-22	3.62E-04	8.5E-04	2.3E+00
Na-24	5.24E-04	8.9E-03	1.7E+01
Ni-63	0.00E+00	0.0E+00	N/A
Np-237	1.25E-04	0.0E+00	0.0E+00
Pm-147	7.23E-10	0.0E+00	0.0E+00
Pu-238	2.14E-05	0.0E+00	0.0E+00
Pu-239	8.15E-06	0.0E+00	0.0E+00
Pu-240	2.03E-05	0.0E+00	0.0E+00
Pu-241	0.00E+00	0.0E+00	0.0E+00
Pu-242	1.68E-05	0.0E+00	0.0E+00
PuBe-238	N/A	N/A	N/A
Ra-226	3.27E-06		
RaBe-226	N/A	N/A	N/A
Rh-100	4.55E-04	4.5E-03	9.9E+00
Rh-101	1.32E-04	2.6E-04	2.0E+00
Rh-102m	4.37E-04	1.1E-03	2.6E+00
Rh-103m	6.91E-06	0.0E+00	0.0E+00
Rh-106	3.73E-05	D(0.07) = 8.4E-03 D(10) = 4.7E-05	2.2E+02 1.3E+00
Ru-103	8.97E-05	1.9E-04	2.1E+00
Ru-106 ^c	3.73E-05	D(0.07) = 8.4E-03 D(10) = 4.7E-05	2.2E+02 1.3E+00
Sb-124	2.88E-04	4.1E-03	1.4E+01
Sb-125	1.03E-04	6.0E-04	5.8E+00
Sn-113	4.84E-05	3.6E-03	7.4E+01
Sr-85	2.05E-04	3.2E-03	1.6E+01
Sr-89	2.21E-08	8.3E-03	3.8E+05
Sr-90/Y-90	0.00E+00	9.7E-03	N/A
Ta-182	2.09E-04	6.6E-04	3.2E+00
Tc-99m	3.32E-05	0.0E+00	0.0E+00
Te-132	7.55E-05	0.0E+00	0.0E+00
Th-228	2.14E-05	0.0E+00	0.0E+00
Th-230	1.86E-05	0.0E+00	0.0E+00
Th-232	1.85E-05	0.0E+00	0.0E+00
Th-234	2.04E-05	0.0E+00	0.0E+00
U-233	7.87E-06	0.0E+00	0.0E+00
U-234	2.10E-05	0.0E+00	0.0E+00
U-235	9.16E-05	0.0E+00	0.0E+00
U-235 Chain ^c	2.39E-04	1.8E-07	7.5E-04
U-238	1.76E-05	0.0E+00	0.0E+00
U-238 Chain ^d	6.24E-05	8.5E-03	1.4E+02
Xe-133	2.78E-05	0.0E+00	0.0E+00
Xe-133m	3.03E-05	0.0E+00	0.0E+00

ATTACHMENT C
BETA-PHOTON RATIO ESTIMATES FOR NTS WORK AREAS AND OPERATIONS
Page 10 of 13

Radionuclide of concern	Photon dose constant, Γ^a mSv/hr per MBq	Beta dose rate at 1 m ^b D(0.07) mGy/hr per MBq	Beta/photon Gy/Sv
Xe-135	5.12E-05	4.8E-03	9.4E+01
Y-88	4.82E-04	0.0E+00	0.0E+00
Y-91	5.40E-07	8.3E-03	1.5E+04
Yb-169	8.84E-05	2.6E-03	2.9E+01
Zr-95 ^e	1.26E-4 +	6.3E-05	2.5E-01
	1.30E-4		
Zr-97 ^e	2.92E-5 +	1.2E-02	7.7E+01
	1.26E-4		

- Values of the photon dose constant, Γ , that were calculated using Equation C-1 are listed in bold.
- Values of beta dose rate that were calculated using the approximation in Equation C-4 are listed in bold.
- In equilibrium with Th-231. mSv/hr per MBq U = 235.
- In equilibrium with Th-234, Pa-234m, and U-234. mSv/hr per MBq U = 238.
- In equilibrium with daughter.

- The photon (gamma and X-ray) decay properties for each nuclide have been obtained from the *WWW Table of Radioactive Isotopes* found on the internet at URL: <http://ie.lbl.gov/toi/nucSearch.asp> (Firestone and Ekström 2002).
- The values of the specific gamma ray dose constant, Γ , were calculated using the following equation:

$$\Gamma = 10^7 [1/(4 \pi R^2)] \sum S_i D(E_i) \quad \text{mSv hr}^{-1} \text{ per MBq, (C-1) where } R = 100 \text{ cm}$$

S_i = emission probability of each photon
 E_i = energy of each photon (MeV)
 $D(E_i)$ = dose rate per unit flux density

The dose rate per unit flux density is determined as follows:

$$\ln D(E) = A + B (\ln E) + C (\ln E)^2 + F (\ln E)^3 \quad \text{(C-2)}$$

where

Photon energy MeV	A	B	C	F
0.01 to 0.03	-20.477	-1.7454		
0.03 to 0.5	-13.626	-0.57117	-1.0954	-0.24897
0.5 to 5.0	-13.133	0.72008	-0.033603	

Values of Γ for nuclides not presented in Table 6.2.2 of Shleien, Slaback, and Birky (1998) were calculated as above and are listed in Table C-3 in bold.

C.4.2 Beta Dose Rates

The beta dose rates as determined in this section are considered to be those at 0.07 mm. The beta decay data for the nuclides listed in Table C-3 were obtained from *WWW Table of Radioactive Isotopes* found on the Internet at URL: <http://ie.lbl.gov/toi/nucSearch.asp> (Firestone and Ekström

ATTACHMENT C
BETA-PHOTON RATIO ESTIMATES FOR NTS WORK AREAS AND OPERATIONS
Page 11 of 13

2002). For comparison, beta dose rates in mGy/hr/MBq were estimated at 1 m. The range of a 350-keV electron in air is approximately 1 m. The beta contributions from nuclides with maximum beta energies ≤ 350 keV were ignored and the beta dose rate at 1 m was set to 0.

The publication of Cross et al. (1982) presents values of dose rates in air for a number of radionuclides of interest at NTS. The dose rate values ($\text{mGy} \cdot \text{cm}^2 \cdot \text{MBq}^{-1} \cdot \text{hr}^{-1}$) are given at various distances, R, from the source out to the beta range in air. Where a value of R = 100 is presented, the dose rate at that distance, divided by $R^2 = 10^4$ is used. In some cases dose rates are given for distances <100 cm and >100 cm. In those cases, the dose rate at 100 cm was determined by interpolation using the values for distances that span 100 cm. The interpolation method that provides the best fit depends on the beta spectral characteristics of the particular nuclide. However, for most nuclides, a linear interpolation yields the best fit, and, considering the overall errors involved, a linear interpolation may be considered adequate.

As an example, in the case of ^{22}Na , dose rates are given at 97.5 cm and 105 cm. The dose rate at 100 cm is determined as follows:

$$R^2 J_{(100)} = R^2 J_{(d1)} - [(100 - d1) \cdot (R^2 J_{(d1)} - R^2 J_{(d3)})] \div (d3 - d1) \quad (\text{C-3})$$

$$R^2 J_{(100)} = R^2 J_{(97.5)} - [(100 - 97.5) \cdot (R^2 J_{(97.5)} - R^2 J_{(105)})] \div (d3 - d1)$$

$$R^2 J_{(100)} = 9.7 - [(2.5) \cdot (9.7 - 6.0)] \div (7.5)$$

$$R^2 J_{(100)} = 8.5 \text{ mGy} \cdot \text{cm}^2 \cdot \text{MBq}^{-1} \cdot \text{hr}^{-1}$$

$$D_{(100)} = R^2 J_{(100)} \div 100^2 = 8.5 \cdot 10^{-4} \text{ mGy/hr per MBq}$$

There are several radionuclides appearing in Table 2-2 and Table C-3 for which dose rate values have not included in Cross et al. (1982). In those cases, the following approximation (IAEA 1979) has been used:

$$D_{(100)} = 0.008 \text{ mGy} \cdot \text{hr}^{-1} \cdot n \cdot C \cdot d^2, \quad (\text{C-4})$$

Where n = fraction of disintegrations that emit a beta
 C = activity in becquerels
 D = distance in meters

Since betas with energies ≥ 350 keV are absorbed in air, the value of $D_{(100)}$ is further reduced by the fraction, F, emitted betas that are so absorbed. As an approximation, F is determined by:

$$F_{\beta} = (E_{\beta} - 350)/E_{\beta}, \quad (\text{C-5})$$

where E_{β} is the beta energy in keV.

For each radionuclide emitting betas with n different maximum energies,

$$F = \sum (E_{\beta i} - 350)/E_{\beta i}, \quad i = 1 \text{ to } n \quad (\text{C-6})$$

ATTACHMENT C
BETA-PHOTON RATIO ESTIMATES FOR NTS WORK AREAS AND OPERATIONS
Page 12 of 13

The nuclides in Table C-1 for which 1-m beta dose rates have been estimated using this approximation are indicated in bold.

C.5 SUMMARY OF BETA-PHOTON RATIOS

A summary and comparison of beta-photon ratios for the radionuclide inventory shown in Table 2-2 is listed in Table C-4. This illustrates the sensitivity of the ratios to the assumptions made in selecting the exposure geometry.

Table C-4. Geometry-dependent beta-photon ratios for NTS radionuclides (Table 2-2).

Radionuclide of concern	Beta-photon ratio – Sv/Sv		
	Surface contamination	Immersion	Point source at 1 m
Ac-227	0.0E+00	2.5E-01	0.0E+00
Am-241	4.0E-04	1.2E-03	0.0E+00
Am-243	9.6E-06	7.9E-04	0.0E+00
AmBe-241	4.0E-04	1.2E-03	N/A
Ba-133	5.9E-05	2.4E-02	0.0E+00
Ba-140	7.8E+00	1.5E+00	2.7E+02
Cd-109	0.0E+00	0.0E+00	0.0E+00
Ce-139	0.0E+00	8.8E-02	0.0E+00
Ce-141	4.7E-01	1.5E+00	1.5E+01
Ce-143	1.0E+01	1.6E+00	5.6E+01
Ce-144 ^a	1.4E+02	1.9E+01	1.5E+03
Cf-252	0.0E+00	3.6E-05	2.4E+00
Cm-244	0.0E+00	0.0E+00	0.0E+00
Co-57	5.0E-05	1.5E-02	0.0E+00
Co-60	3.7E-03	1.8E-02	9.8E+01
Cs-134	2.0E-01	8.9E-02	0.0E+00
Cs-137 ^a	2.1E+02	3.9E+02	5.2E+00
Eu-152	3.3E-01	6.9E-02	
Eu-154	1.1E+00	1.9E-01	1.5E+01
Eu-155	0.0E+00	1.1E-01	1.4E+01
Fe-59	1.5E-02	5.9E-02	0.0E+00
H-3	-	-	2.8E-01
Hg-203	3.7E-06	1.9E-01	N/A
I-131	4.3E-01	4.1E-01	0.0E+00
I-132	1.9E+00	2.4E-01	
I-133	5.4E+00	7.2E-01	1.8E+01
I-135	1.8E+00	2.4E-01	
Ir-192	2.6E-01	2.2E-01	
Kr-85	2.2E+02	9.4E+01	7.5E+00
Lu-174	6.3E-03	1.8E-03	8.3E+03
Mn-54	3.1E-03	2.8E-04	1.8E+02
Mo-99	2.0E+01	2.7E+00	2.0E+01
Na-22	4.6E-02	7.5E-02	2.3E+00
Na-24	1.5E+00	1.4E-01	1.7E+01
Ni-63	N/A	N/A	N/A
Np-237	0.0E+00	5.2E-02	0.0E+00

ATTACHMENT C
BETA-PHOTON RATIO ESTIMATES FOR NTS WORK AREAS AND OPERATIONS

Page 13 of 13

Radionuclide of concern	Beta-photon ratio – Sv/Sv		
	Surface contamination	Immersion	Point source at 1 m
Pm-147	0.0E+00	6.6E+02	0.0E+00
Pu-238	8.8E-04	1.2E-02	0.0E+00
Pu-239	3.2E-04	3.5E-02	0.0E+00
Pu-240	1.2E-06	1.2E-02	0.0E+00
Pu-241	0.0E+00	1.2E-01	0.0E+00
Pu-242	0.0E+00	1.5E-02	0.0E+00
PuBe-238	8.8E-04	1.2E-02	N/A
Ra-226	7.9E-05	3.1E-01	-
RaBe-226	7.9E-05	3.1E-01	N/A
Rh-100	2.4E-01	2.7E-02	9.9E+00
Rh-101	5.2E-05	4.2E-02	2.0E+00
Rh-102m	2.8E+00	3.7E-01	2.6E+00
Rh-103m	0.0E+00	0.0E+00	0.0E+00
Rh-106	5.5E+01	8.2E+00	2.2E+02
Ru-103	1.1E-01	6.4E-02	1.3E+00
Ru-106 ^a	5.5E+01	8.2E+00	2.2E+02
Sb-124	1.6E+00	2.2E-01	1.4E+01
Sb-125	1.3E-01	1.2E-01	5.8E+00
Sn-113	0.0E+00	1.2E-02	7.4E+01
Sr-85	5.2E-02	7.7E-03	1.6E+01
Sr-89	1.8E+03	3.8E+02	3.8E+05
Sr-90	2.1E+02	8.4E+02	-
Ta-182	1.3E-01	8.2E-02	3.2E+00
Tc-99m	0.0E+00	4.4E-02	0.0E+00
Te-132	0.0E+00	1.2E-01	0.0E+00
Th-228	0.0E+00	1.4E-01	0.0E+00
Th-230	0.0E+00	6.6E-02	0.0E+00
Th-232	0.0E+00	9.0E-02	0.0E+00
Th-234	0.0E+00	7.1E-01	0.0E+00
U-233	2.6E-05	2.0E-01	0.0E+00
U-234	1.1E-04	7.5E-02	0.0E+00
U-235	3.6E-05	3.0E-02	0.0E+00
U-235 chain ^a	4.1E-01	2.0E-01	7.5E-04
U-238	0.0E+00	0.0E+00	0.0E+00
U-238 chain ^b	1.7E+02	3.1E+01	1.4E+02
Xe-133	1.1E-07	1.3E+00	0.0E+00
Xe-133m	0.0E+00	4.5E+00	0.0E+00
Xe-135	6.2E+00	1.3E+00	9.4E+01
Y-88	3.6E-03	5.2E-04	0.0E+00
Y-90	1.3E+03	2.7E+02	1.5E+04
Y-91	8.8E+02	1.3E+02	
Yb-169	6.0E-05	1.0E-01	2.5E-01
Zr-95 ^c	2.7E-02	5.0E-02	
Zr-97 ^c	2.3E+01	2.6E+00	

a. In equilibrium with Th-231. mSv/hr per MBq U = 235.

b. In equilibrium with Th-234, Pa-234m, and U-234. mSv/hr per MBq U = 238.

c. In equilibrium with daughter.

**ATTACHMENT D
NEUTRON DOSES FROM ATMOSPHERIC NUCLEAR TESTS**

Page 1 of 5

TABLE OF CONTENTS

<u>SECTION</u>	<u>TITLE</u>	<u>PAGE</u>
D.1	Introduction	123
D.2	Neutron Dose as a Function of Distance	123

D.1 INTRODUCTION

One hundred atmospheric nuclear tests were conducted at NTS from January 27, 1951 to July 17, 1962 (DOE 2000). Essentially all the neutrons accompanying a nuclear explosion are released either in the fission or fusion process. All of the neutrons from the fusion and more than 99% of the fission neutrons are produced almost immediately, within less than a millionth of a second of the initiation of the explosion (Glasstone and Dolan 1977). These are referred to as the "prompt" neutrons. In addition, somewhat less than 1% of the fission neutrons, called the "delayed" neutrons, are emitted subsequently. The majority of these delayed neutrons are released within the first minute, and so constitute part of the initial nuclear radiation. While the shielding afforded by even a few feet of soil attenuates the neutrons from underground tests by several orders of magnitude, only distance and minor attenuation by air contribute to the reduction of neutron dose from atmospheric tests. Therefore, in principle, significant occupational neutron exposure from an atmospheric test was possible if the person was close enough to the detonation point.

D.2 NEUTRON DOSE AS A FUNCTION OF DISTANCE

The spectra of neutrons produced by fission and thermonuclear weapons are illustrated in Figure D-1 (Glasstone and Dolan 1977). The presentation is in terms of total neutrons per energy group per kiloton (kT) weapon yield. Based on these spectra, the neutron yield for a fission weapon would be about 7.7×10^{22} neutrons per kT, and for a thermonuclear weapon, the yield would be about 1.4×10^{23} neutrons per kT. The fission neutron spectrum does not change very much to a distance of at least 1,600 yd. In contrast, for thermonuclear spectra, the relative contribution for neutrons above about 8-MeV decreases markedly for 400 to 1600 yd (Glasstone and Dolan 1977).

Neutron dose as a function of slant range can be determined from the neutron spectra as a function of distance (Figure D-2; Glasstone and Dolan 1977) for (1) fission and (2) thermonuclear air bursts. In the case of a fission weapon detonation, two curves are presented – offensive and defensive. The difference is the result of differences in weapons parameters. The defensive curves were used in prediction of slant range doses. The neutron dose as a function of slant range from Figure D-2 is compared in Figure D-3, which shows little difference between fission and thermonuclear weapon doses per kiloton. Using a radiation weighting factor of 20, the dose equivalent as a function of slant range is presented in Figure D-4 for a range of thermonuclear yields from 1 kT to 1 MT. Although the yield range is 3 orders of magnitude, the predicted 1-mrem dose equivalent slant range varies from about 3.8 km for 1 kT to 5.2 km for 1 MT.

ATTACHMENT D NEUTRON DOSES FROM ATMOSPHERIC NUCLEAR TESTS

Page 2 of 5

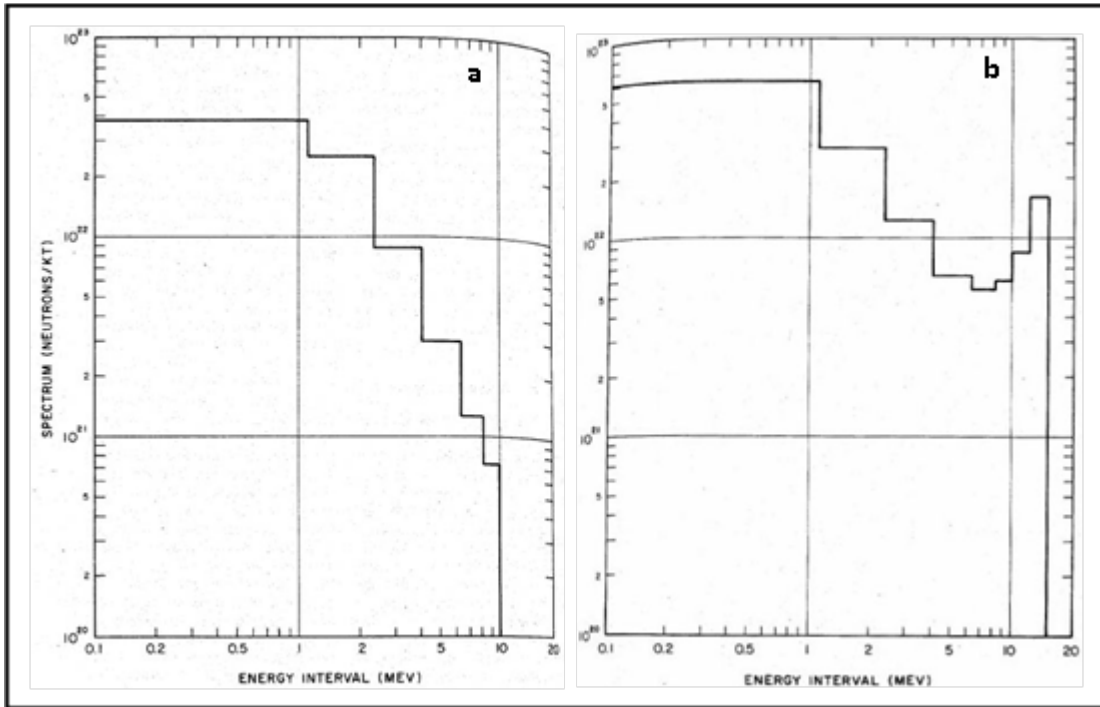

Figure D-1. Neutron spectra for (a) fission weapon and (b) thermonuclear weapon per kiloton total energy yield (Glasstone and Dolan 1977).

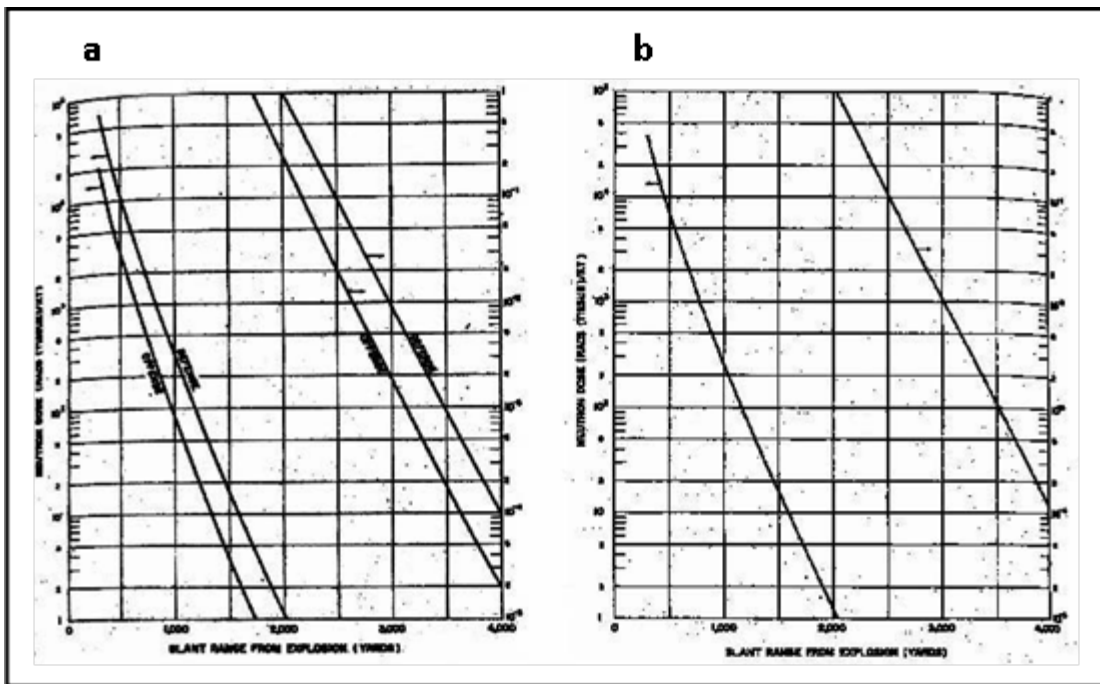

Figure D-2. Initial neutron dose per kT as a function of slant range from (a) fission and (b) thermonuclear air bursts, based on 0.9 normal sea-level air density (Glasstone and Dolan 1977).

ATTACHMENT D NEUTRON DOSES FROM ATMOSPHERIC NUCLEAR TESTS

Page 3 of 5

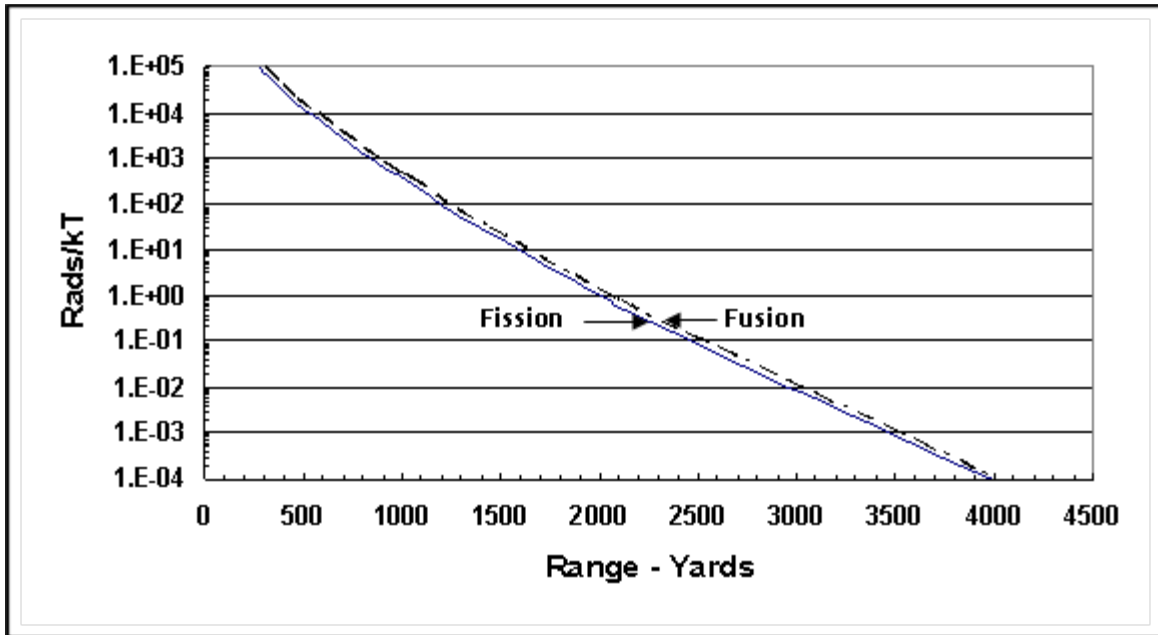

Figure D-3. Comparison of the initial neutron dose per kiloton as a function of slant range from fission and thermonuclear air bursts (after Glasstone and Dolan 1977).

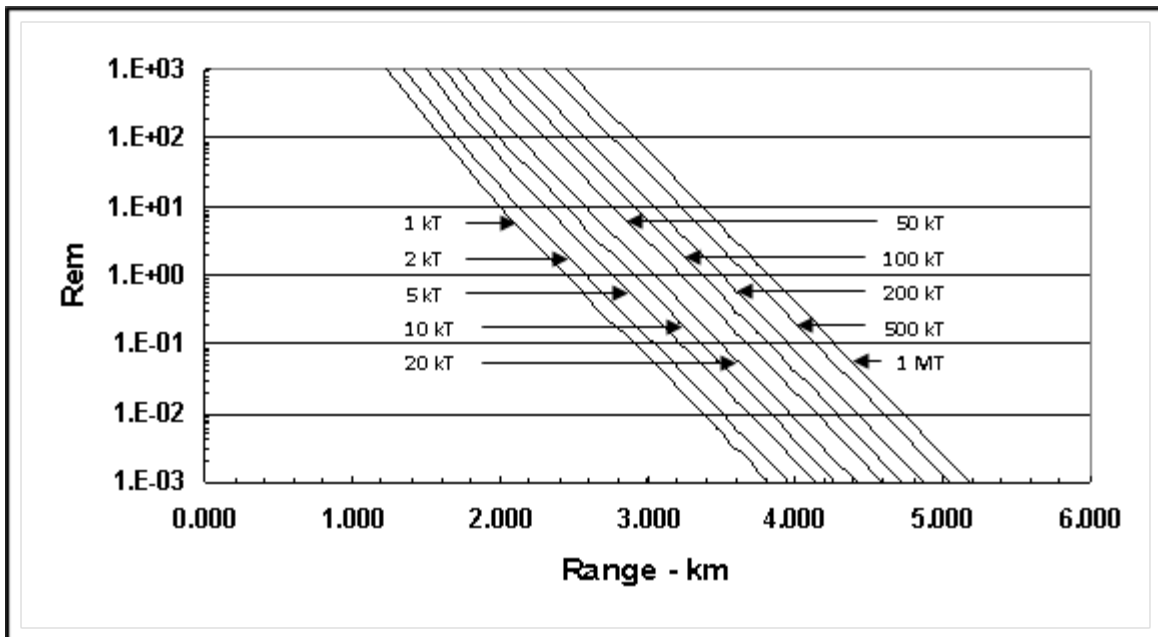

Figure D-4. Neutron dose equivalent as a function of slant range for atmospheric detonations with a range of weapon yields.

The Defense Nuclear Agency has published a report on neutron exposure to DOD personnel during nuclear tests (DNA 1985). The results are based on radiation transport calculations using the ATR (Air Transport of Radiation) computer code.

ATTACHMENT D
NEUTRON DOSES FROM ATMOSPHERIC NUCLEAR TESTS

Page 4 of 5

Calculations were made for NTS and the Pacific Proving Ground tests, taking into account differences in test conditions such as altitude (air density) and humidity. The results of these calculations are presented in terms of dose equivalent using a quality factor of 13.

The isodose contours for the continental detonations are shown in Figure D-5 (DNA 1985). Two tests were used to bound the range of possible results:

- Operation RANGER, Test EASY: The neutron spectrum was that of a pure fission device, typical of earlier weapons. The mean air density between the surface and burst height (330 m) is $1.18 \times 10^{-3} \text{ g/cm}^3$, a very high value for NTS tests. The higher density and resulting increase in attenuation results in a lower neutron dose at a given range.
- Operation PLUMBOB, Test HOOD: The neutron source spectrum was that of a boosted fission device, typical of later weapons. The mean air density between the surface and burst height (460 m) is $0.992 \times 10^{-3} \text{ g/cm}^3$, the lowest of any low-altitude NTS detonation. The low air density and enhanced neutron output result in a higher neutron dose at a given range.

Using the data in Figure D-5, the 1-mrem slant range at the surface for 1- to 80-kT detonations from about 4.1 km to 5 km are consistent with the data from Glasstone (Glasstone and Dolan 1977). Therefore, it can reasonably be concluded that personnel working on the surface beyond a range of 6 km would receive neutron doses less than 1 mrem for the NTS atmospheric test series.

The isodose curves in Figure D-5 also provide information on neutron doses at altitudes as high as 9 km (29,500 ft). This information is useful in assessing potential neutron exposures to air crews associated with the testing program.

ATTACHMENT D NEUTRON DOSES FROM ATMOSPHERIC NUCLEAR TESTS

Page 5 of 5

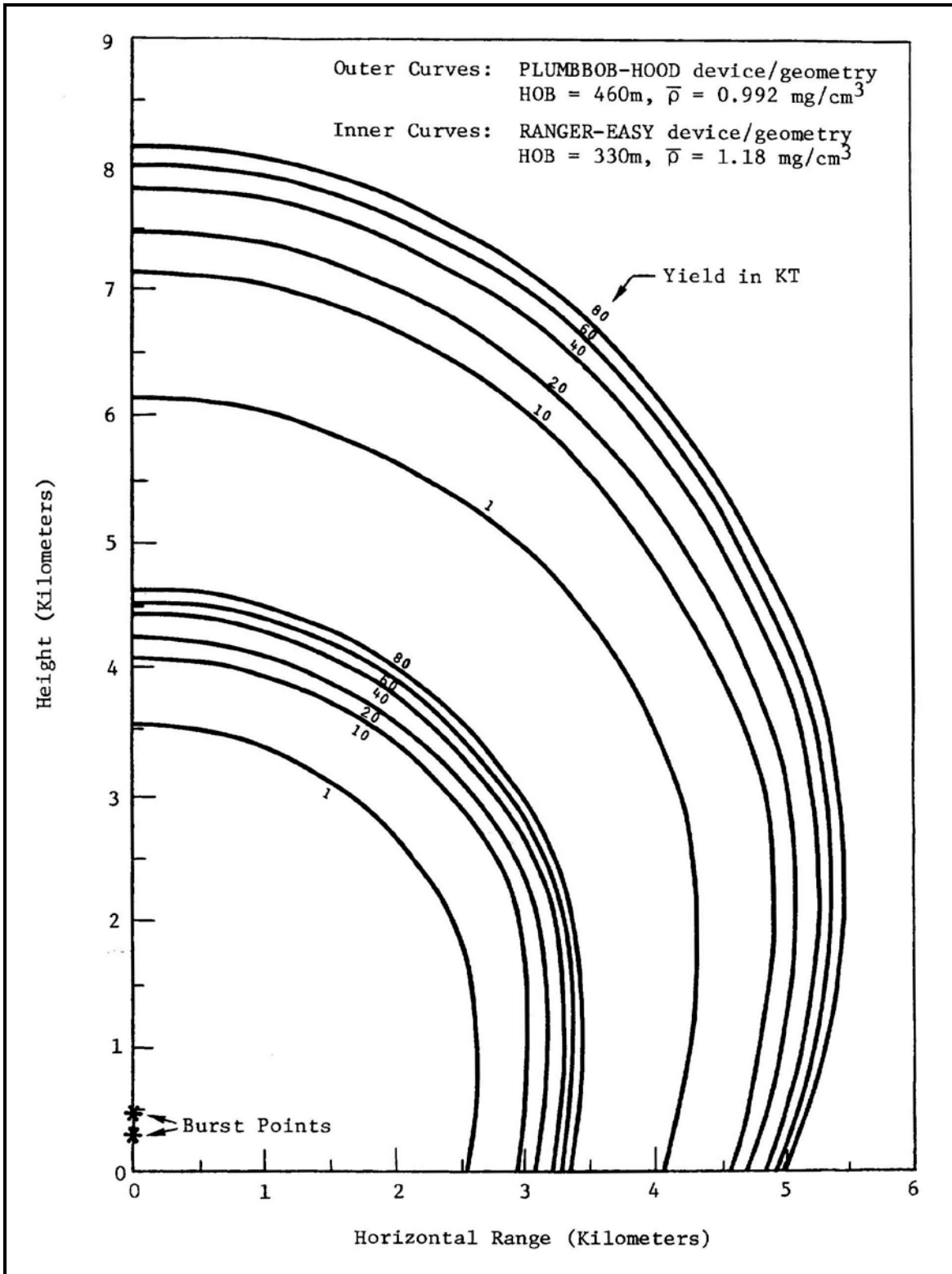

Figure D-5. 1-mrem neutron isodose curves for continental detonations (DNA 1985).